

LCE Series



Agency Approvals

AGENCY	AGENCY FILE NUMBER
	E128662/E230531

**Maximum Ratings and Thermal Characteristics
(T_A=25°C unless otherwise noted)**

Parameter	Symbol	Value	Unit
Peak Pulse Power Dissipation by 10x1000µs test waveform (Fig.1) (Note 1)	P _{PPM}	1500	W
Steady State Power Dissipation on infinite heat sink at T _L =75°C (Fig. 5)	P _D	6.5	W
Operating Junction and Storage Temperature Range	T _J , T _{STG}	-55 to 175	°C

Note:

1. Non-repetitive current pulse, per Fig. 3 and derated above T_A = 25°C per Fig. 2.

Description

The LCE Series is designed specifically to protect sensitive electronic equipment from voltage transients induced by lightning and other transient voltage events.

Features

- Glass passivated chip junction in DO-201 Package
- 1500W peak pulse power capability at 10x1000µs waveform, repetition rate (duty cycles):0.01 %
- Fast response time: typically less than 1.0ps from 0 Volts to BV min
- Excellent clamping capability
- Typical failure mode is short from over-specified voltage or current
- Whisker test is conducted based on JEDEC JESD201A per its table 4a and 4c
- IEC-61000-4-2 ESD 15kV(Air), 8kV (Contact)
- ESD protection of data lines in accordance with IEC 61000-4-2 (IEC801-2)
- EFT protection of data lines in accordance with IEC 61000-4-4 (IEC801-4)
- Low incremental surge resistance
- High temperature soldering guaranteed: 260°C/40 seconds / 0.375"(9.5mm) lead length, 5 lbs., (2.3kg) tension
- Plastic package has underwriters laboratory flammability classification 94V-0
- Matte tin lead-free plated
- Ideal for data line applications
- Halogen free and RoHS compliant

Applications

TVS devices are ideal for the protection of I/O interfaces, V_{CC} bus and other vulnerable circuits used in telecom, computer, industrial and consumer electronic applications.

LCE Series

Electrical Characteristics

Part Number	Reverse Stand off Voltage V_R (V)	Breakdown Voltage V_{BR} (V)		Test Current I_T (mA)	Maximum Reverse Leakage $I_R @ V_R$ (μ A)	Maximum Clamping Voltage at I_{PP} V_C (V)	Maximum Peak Pulse Current (Fig.3) I_{PPM} (A)	Maximum Junction Capacitance @ 0Volts (pF)	Working Inverse Blocking Voltage V_{WIB} (V)	Inverse Blocking Leakage Current at $I_{IB} @ V_{WIB}$ (mA)	Peak Inverse Blocking Voltage V_{PIB} (V)	Agency Approval 
		MIN	MAX									
LCE6.5A	6.5	7.22	7.98	10	1000	11.2	100.0	100	75	1.0	100	X
LCE7.0A	7.0	7.78	8.60	10	500	12.0	100.0	100	75	1.0	100	X
LCE7.5A	7.5	8.33	9.21	10	250	12.9	100.0	100	75	1.0	100	X
LCE8.0A	8.0	8.89	9.83	1	100	13.6	100.0	100	75	1.0	100	X
LCE8.5A	8.5	9.44	10.40	1	50	14.4	100.0	100	75	1.0	100	X
LCE9.0A	9.0	10.00	11.10	1	10	15.4	97.0	100	75	1.0	100	X
LCE10A	10.0	11.10	12.30	1	5	17.0	88.0	100	75	1.0	100	X
LCE11A	11.0	12.20	13.50	1	1	18.2	82.0	100	75	1.0	100	X
LCE12A	12.0	13.30	14.70	1	1	19.9	75.0	100	75	1.0	100	X
LCE13A	13.0	14.40	15.90	1	1	21.5	70.0	100	75	1.0	100	X
LCE14A	14.0	15.60	17.20	1	1	23.2	65.0	100	75	1.0	100	X
LCE15A	15.0	16.70	18.50	1	1	24.4	61.0	100	75	1.0	100	X
LCE16A	16.0	17.80	19.70	1	1	26.0	57.0	100	75	1.0	100	X
LCE17A	17.0	18.90	20.90	1	1	27.6	54.0	100	75	1.0	100	X
LCE18A	18.0	20.00	22.10	1	1	29.2	51.0	100	75	1.0	100	X
LCE20A	20.0	22.20	24.50	1	1	32.4	46.0	100	75	1.0	100	X
LCE22A	22.0	24.40	26.90	1	1	35.5	42.0	100	75	1.0	100	X
LCE24A	24.0	26.70	29.50	1	1	38.9	39.0	100	75	1.0	100	X
LCE26A	26.0	28.90	31.90	1	1	42.1	36.0	100	75	1.0	100	X
LCE28A	28.0	31.10	34.40	1	1	45.5	33.0	100	75	1.0	100	X
LCE30A	30.0	33.30	36.80	1	1	48.4	31.0	100	75	1.0	100	
LCE33A	33.0	36.70	40.60	1	1	53.3	28.1	100	75	1.0	100	
LCE36A	36.0	40.00	44.20	1	1	58.1	25.8	100	75	1.0	100	
LCE40A	40.0	44.40	49.10	1	1	64.5	23.3	100	75	1.0	100	
LCE43A	43.0	47.80	52.80	1	1	69.4	21.6	100	75	1.0	100	
LCE45A	45.0	50.00	55.30	1	1	72.7	20.6	100	75	1.0	100	
LCE48A	48.0	53.30	58.90	1	1	77.4	19.4	100	75	1.0	100	
LCE51A	51.0	56.70	62.70	1	1	82.4	18.2	100	75	1.0	100	
LCE54A	54.0	60.00	66.30	1	1	87.1	17.2	100	100	1.0	125	
LCE58A	58.0	64.40	71.20	1	1	93.6	16.0	100	100	1.0	125	
LCE60A	60.0	66.70	73.70	1	1	96.8	15.5	100	100	1.0	125	
LCE64A	64.0	71.10	78.60	1	1	103.0	14.6	100	100	1.0	125	
LCE70A	70.0	77.80	86.00	1	1	113.0	13.3	100	125	1.0	150	
LCE75A	75.0	83.30	92.10	1	1	121.0	12.4	100	125	1.0	150	
LCE85A	85.0	94.40	104.00	1	1	129.0	11.6	100	125	1.0	150	
LCE90A	90.0	100.00	111.00	1	1	146.0	10.3	100	125	1.0	150	

Note: For parts without A, the V_{BR} is +10% and V_C is 5% higher than with A parts.

Ratings and Characteristic Curves ($T_A=25^\circ\text{C}$ unless otherwise noted)

Figure 1 - Peak Pulse Power Rating

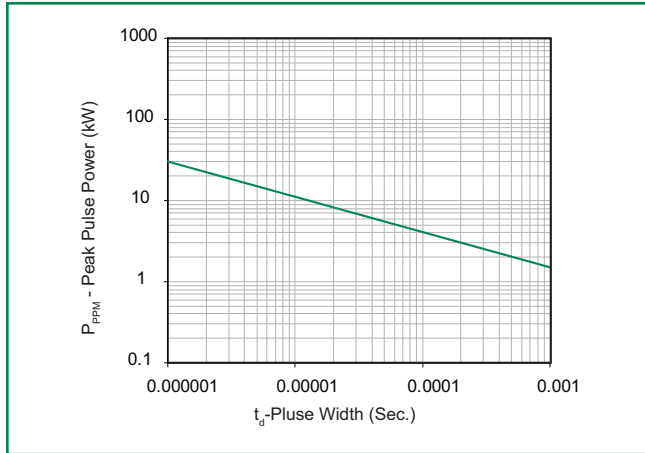

Figure 2 - Power Derating Curve

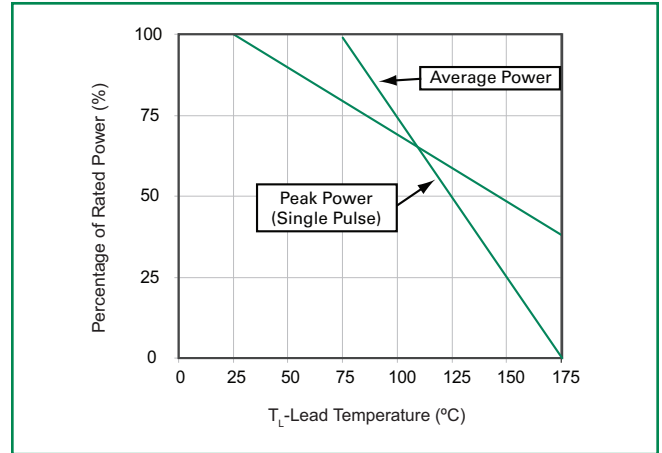

Figure 3 - Pulse Waveform

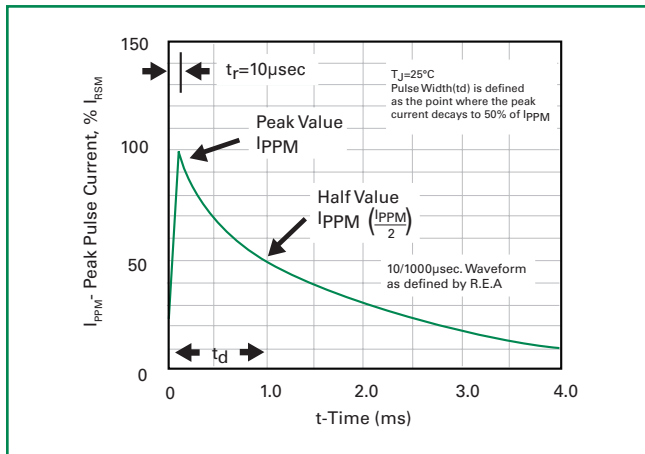

Figure 4 - AC Line Protection Application

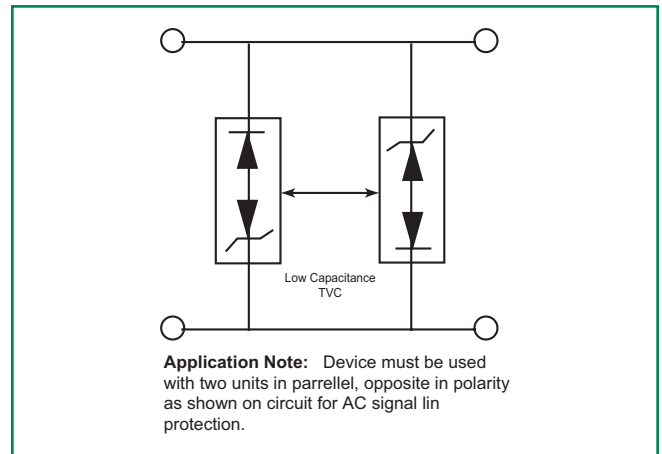
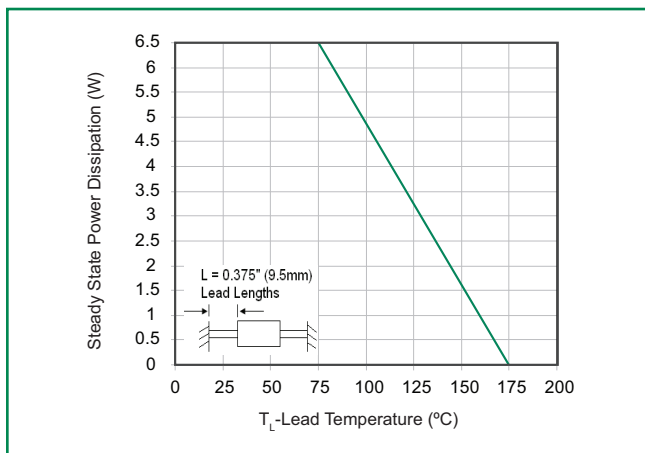
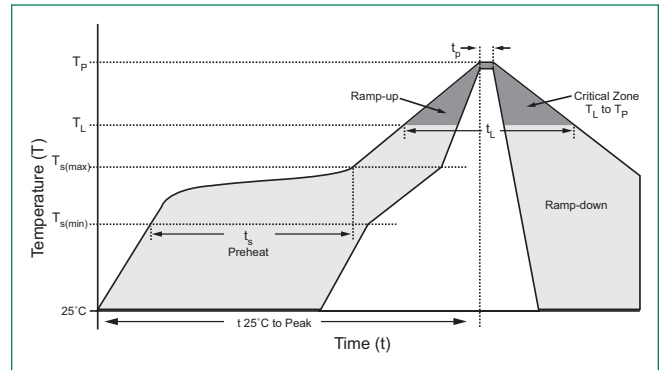

Figure 5 - Steady State Power Derating Curve



Soldering Parameters

Reflow Condition		Lead-free assembly
Pre Heat	- Temperature Min ($T_{s(min)}$)	150°C
	- Temperature Max ($T_{s(max)}$)	200°C
	- Time (min to max) (t_s)	60 – 180 secs
Average ramp up rate (Liquidus Temp (T_L) to peak)		3°C/second max
$T_{s(max)}$ to T_L - Ramp-up Rate		3°C/second max
Reflow	- Temperature (T_L) (Liquidus)	217°C
	- Time (min to max) (t_s)	60 – 150 seconds
Peak Temperature (T_p)		260 ^{+0/-5} °C
Time within 5°C of actual peak Temperature (t_p)		20 – 40 seconds
Ramp-down Rate		6°C/second max
Time 25°C to peak Temperature (T_p)		8 minutes Max.
Do not exceed		280°C



Flow/Wave Soldering (Solder Dipping)

Peak Temperature :	265°C
Dipping Time :	10 seconds
Soldering :	1 time

Physical Specifications

Weight	0.045oz., 1.2g
Case	JEDEC DO-201 molded plastic body over passivated junction.
Polarity	Color band denotes the cathode except Bipolar.
Terminal	Matte Tin axial leads, solderable per JESD22-B102D.

Environmental Specifications

Temperature Cycle	JESD22-A104
Pressure Cooker	JESD 22-A102
High Temp. Storage	JESD22-A103
HTRB	JESD22-A108
Thermal Shock	JESD22-A106

Dimensions

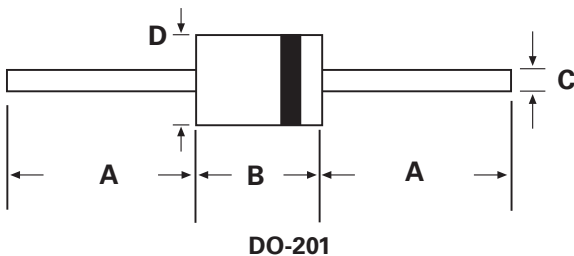

Dimensions	Inches		Millimeters	
	Min	Max	Min	Max
A	1.000	-	25.40	-
B	0.285	0.375	7.20	9.50
C	0.038	0.042	0.96	1.07
D	0.190	0.210	4.80	5.30

Part Numbering System

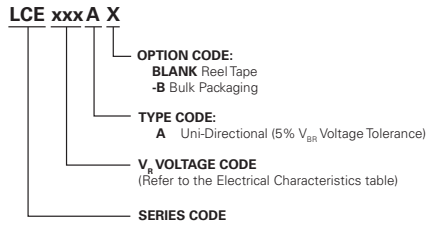

Part Marking System

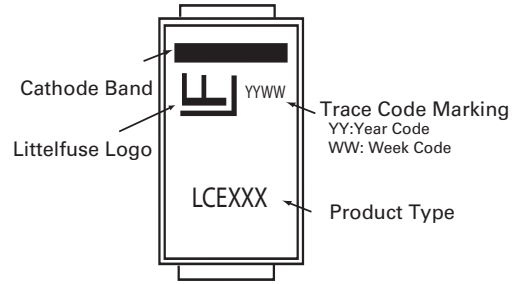

Packaging

Part Number	Component Package	Quantity	Packaging Option	Packaging Specification
LCExxxXX	DO-201	1200	Tape & Reel	EIA STD RS-296E
LCExxxXX-B	DO-201	500	BULK	Littelfuse Concord Packing Spec. DM-0016

Schematic

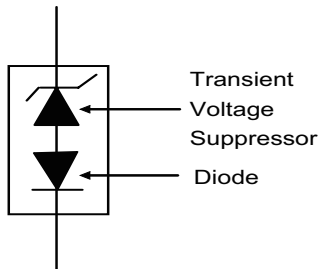

Tape and Reel Specification

