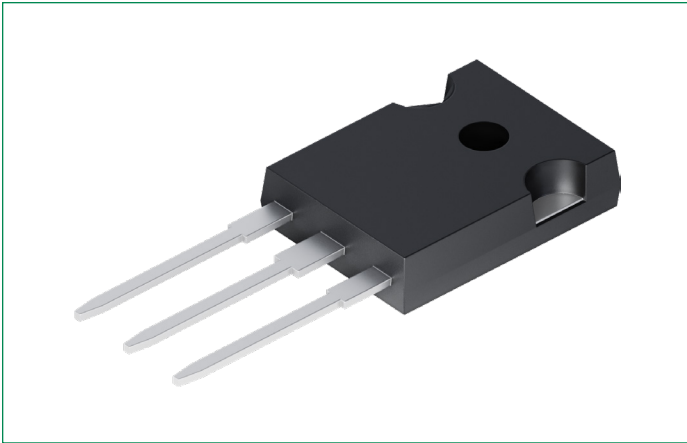

DCK20C1200HB

1200 V, 20 A SiC Schottky Diode

RoHS

HF

**Features**

- Max junction temperature of 175 °C
- High surge current capacity
- Zero reverse recovery current
- Zero forward recovery voltage
- High-frequency operation
- Temperature independent switching behavior
- Positive temperature coefficient on V_F

Applications

- Solar power boost
- Inverter free wheeling diodes
- Vienna 3-Phase PFC
- AC/DC converters
- Switching mode power supplies

Product Summary

Characteristic	Value	Unit
V_{RRM}	1200	V
I_F ($T_c = 155\text{ °C}$)	10*	A
Q_c	62*	nC

* per leg

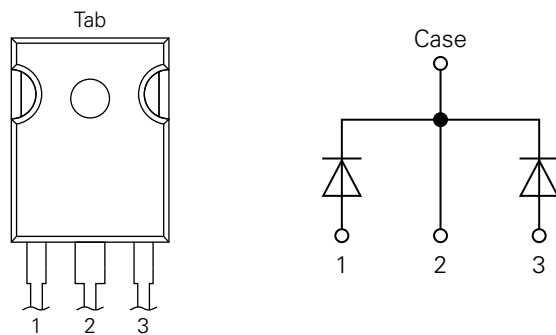
Pinout Diagram TO-247-3L**1:** Anode; **2:** Cathode; **3:** Anode; **Tab:** Case

Maximum Ratings ($T_c = 25\text{ °C}$ unless otherwise specified)

Symbol	Characteristic	Conditions	Value	Unit	
V_{RRM}	Repetitive peak reverse voltage	–	1200	V	
V_{DC}	DC blocking voltage	–	1200	V	
I_F	Continuous forward current	–	$T_c = 25\text{ °C}$	30*	A
			$T_c = 135\text{ °C}$	15.2*	
			$T_c = 155\text{ °C}$	10*	
I_{FSM}	Non-repetitive surge forward current	Sine halfwave @ $T_c = 25\text{ °C}$, $t_p = 10\text{ ms}$	72*	A	
I_{FRM}	Repetitive peak forward current	Frequency = 0.1 Hz, 100 cycles sine halfwave @ $T_c = 25\text{ °C}$, $t_p = 10\text{ ms}$	56*	A	
P_{tot}	Total power dissipation	–	$T_c = 25\text{ °C}$	176*	W
			$T_c = 150\text{ °C}$	29*	
I^2t	I^2t	$T_c = 25\text{ °C}$, $t_p = 10\text{ ms}$	26*	A ² s	
T_{vj}	Virtual operating junction temperature range	–	–55 to 175	°C	
T_{stg}	Storage temperature range	–	–55 to 175	°C	
M	Mounting torque	M3 screw	0.7	Nm	

* per leg

Note: Stresses exceeding those listed in the Maximum Ratings table may damage the device. If any of these limits are exceeded, device functionality should not be assumed, damage may occur and reliability may be affected.

Thermal Characteristics (per leg)

Symbol	Characteristic	Value			Unit
		Min.	Typ.	Max.	
$R_{th(j-c)}$	Thermal resistance, junction to case Fig.7	–	0.85	–	K/W

Electrical Characteristics (per leg) ($T_{vj} = 25\text{ °C}$ unless otherwise specified)

Symbol	Characteristic	Conditions	Value			Unit	
			Min.	Typ.	Max.		
V_F	Forward voltage Fig.1	$I_F = 10\text{ A}$	$T_{vj} = 25\text{ °C}$	–	1.48	1.7	V
			$T_{vj} = 175\text{ °C}$	–	2.0	3.0	
I_R	Reverse current Fig.2	$V_R = 1200\text{ V}$	$T_{vj} = 25\text{ °C}$	–	1	100	μA
			$T_{vj} = 175\text{ °C}$	–	10	250	
C	Total capacitance Fig.3	$V_R = 1\text{ V}$, $f = 1\text{ MHz}$	–	575	–	pF	
		$V_R = 400\text{ V}$, $f = 1\text{ MHz}$	–	59	–		
		$V_R = 800\text{ V}$, $f = 1\text{ MHz}$	–	42.5	–		
Q_c	Total capacitive charge Fig.4	$V_R = 800\text{ V}$, $T_{vj} = 25\text{ °C}$, $Q_c = \int_0^{V_R} C(V)dV$	–	62	–	nC	
E_c	Capacitance stored energy Fig.5	$V_R = 800\text{ V}$, $T_{vj} = 25\text{ °C}$, $E_c = \int_0^{V_R} C(V) \cdot VdV$	–	16.8	–	μJ	

Characteristic Curves

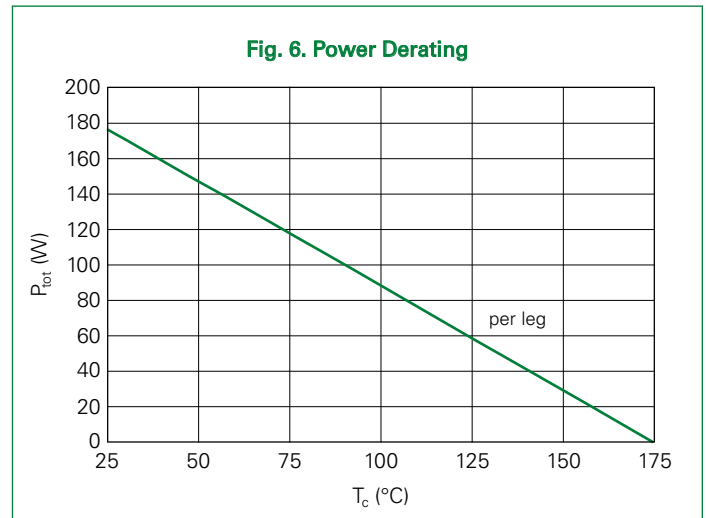
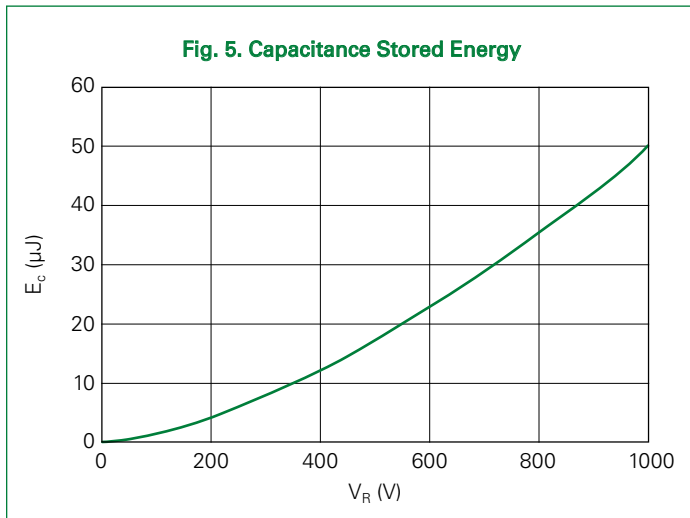
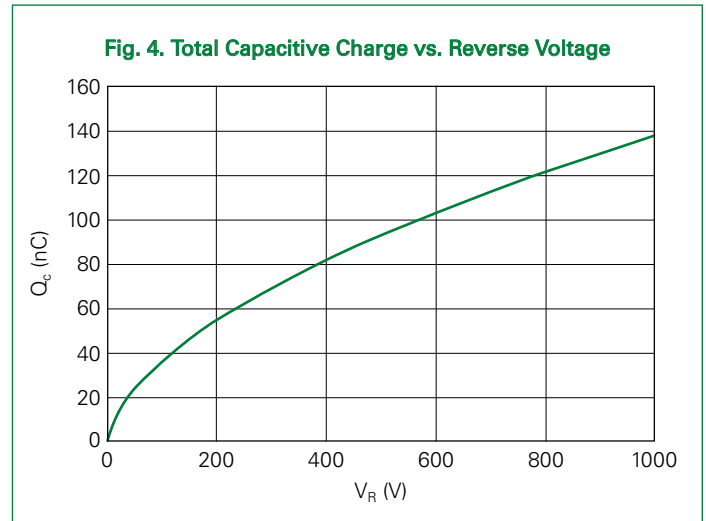
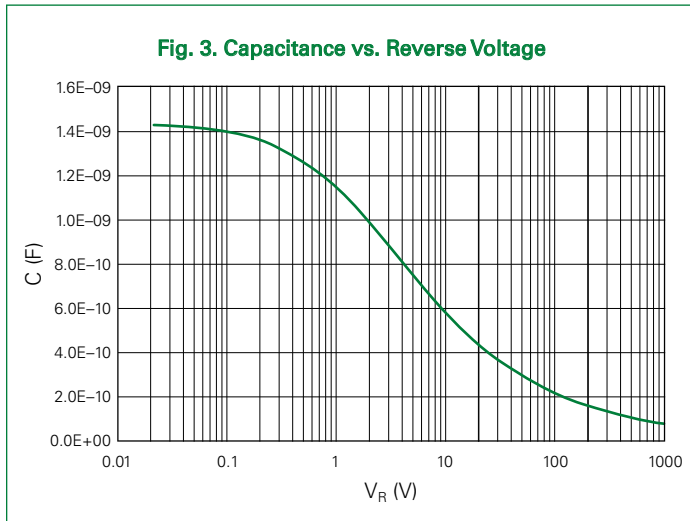
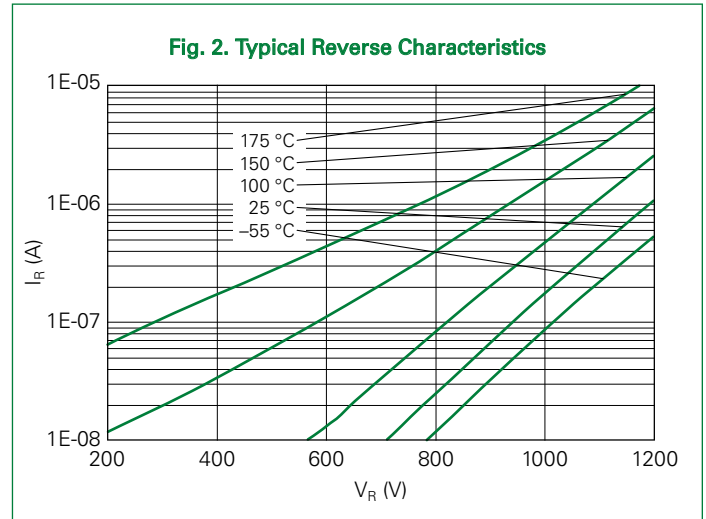
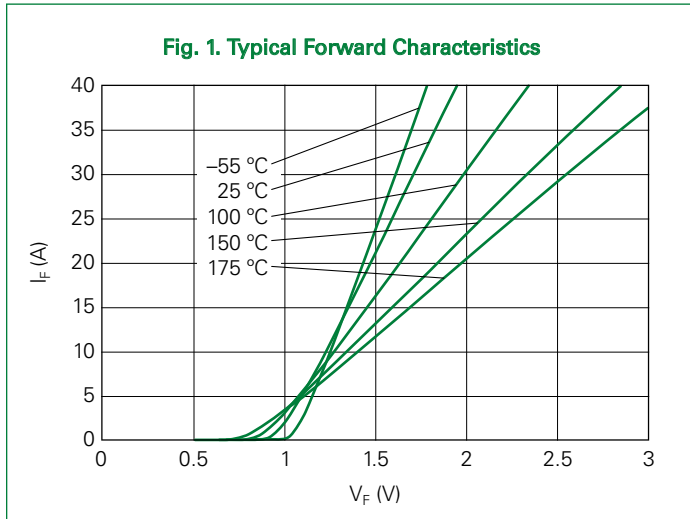

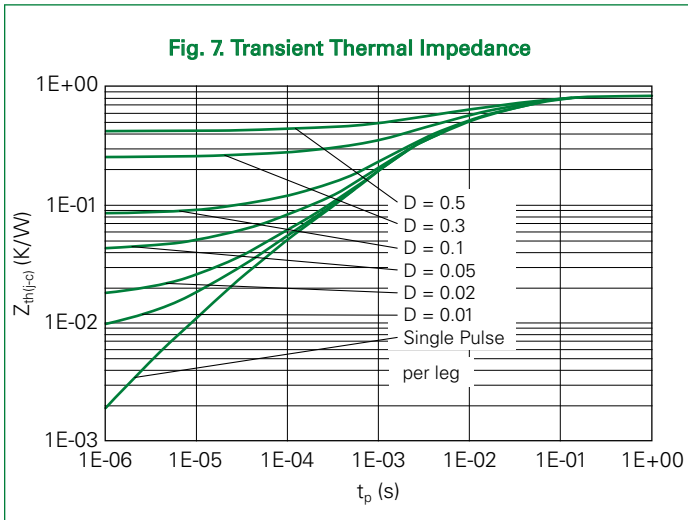

Diode V_F Model for Simulation

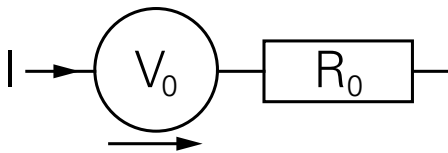

$$V_F(T_j) = V_0 + IR_0$$

$$V_0 = -2 \times 10^{-7} \cdot T_j^2 - 0.0011 \cdot T_j + 1.0148$$

$$R_0 = 8 \times 10^{-7} \cdot T_j^2 + 0.0001 \cdot T_j + 0.0255$$

Notes

- T_j is the junction temperature in °C
- Range valid from 25 °C to 175 °C
- Model represents performance of a typical chart

Part Number and Marking

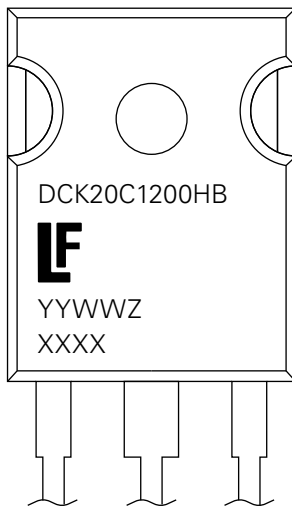

DCK20C1200HB = Part Material Number

YY = Year

WW = Work Week

Z = Assembly Location

XXXX = Lot Traceability

Part Outline Drawing TO-247-3L

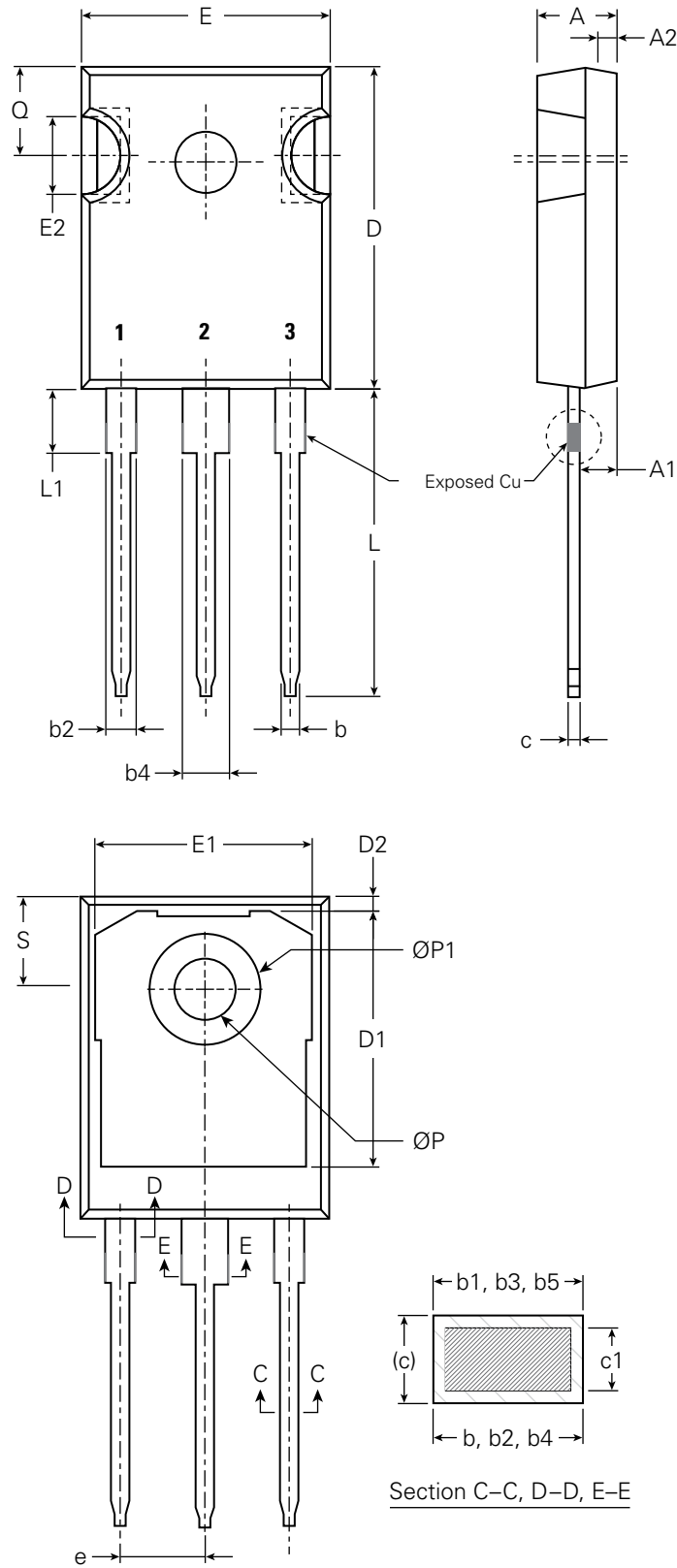

Symbol	Inches			Millimeters		
	Min.	Typical	Max.	Min.	Typical	Max.
A	0.190	-	0.205	4.83	-	5.21
A1	0.087	-	0.102	2.20	-	2.60
A2	0.059	-	0.098	1.50	-	2.49
b	0.039	-	0.055	1.00	-	1.40
b1	0.039	-	0.053	0.99	-	1.35
b2	0.071	-	0.095	1.80	-	2.41
b3	0.065	-	0.094	1.65	-	2.39
b4	0.110	-	0.133	2.80	-	3.38
b5	0.104	-	0.125	2.65	-	3.18
c	0.020	-	0.028	0.50	-	0.70
c1	0.015	-	0.028	0.38	-	0.70
D	0.799	-	0.831	20.30	-	21.10
D1	0.515	-	-	13.08	-	-
D2	0.020	-	0.053	0.51	-	1.35
E	0.608	-	0.635	15.45	-	16.13
E1	0.516	-	-	13.10	-	-
E2	0.145	-	0.216	3.68	-	5.49
e	0.214 BSC			5.44 BSC		
L	0.780	-	0.827	19.80	-	21.00
L1	-	-	0.177	-	-	4.50
ØP	0.138	-	0.146	3.50	-	3.70
ØP1	-	-	0.291	-	-	7.40
Q	0.212	-	0.244	5.39	-	6.20
S	0.238	-	0.248	6.04	-	6.30

Note:

1. Package Reference: JEDEC TO247, Variation AD
2. Slot required, notch may be rounded or rectangular
3. Dimension D&E do not include mold flash
4. Subject to change without notice

Disclaimer Notice

Information furnished is believed to be accurate and reliable. However, users should independently evaluate the suitability of and test each product selected for their own applications. Littelfuse products are not designed for, and may not be used in, all applications. Read complete Disclaimer Notice at <http://www.littelfuse.com/disclaimer-electronics>.



Part of:

