

DCNHR Series

900V DC Max Contactor Relays

OBSOLETE: June, 2025

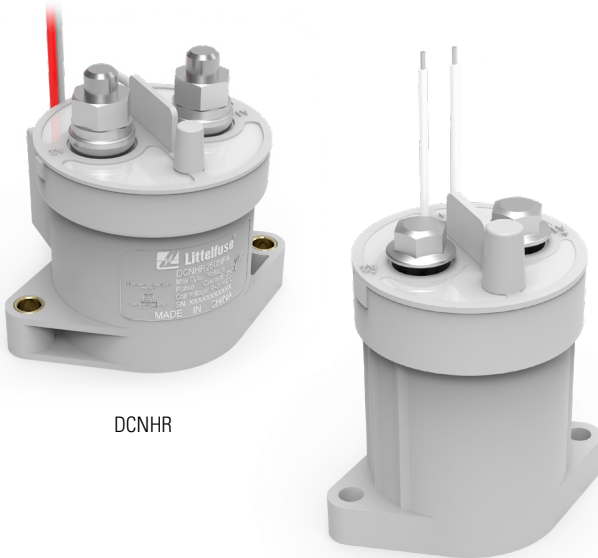

DCNHR

Specifications

Max Voltage Rating (V DC):	900
Current Rating Continuous (A):	20-500
Ingress Protection:	20-100: IP67 150-300: Main contacts IP67 PWM circuit IP54
Operating Temperature (°C):	-40 to +85
Approvals:	E47258 Recognized
UL File Number:	EN 60947-4-1, 2018
CE:	

Description

The DCNHR Series 450V High-Current High-Voltage DC Contactor Relay is a normally open (also known as monostable) relay with a resin body for corrosion resistance in harsh automotive environments. Versions are available with a pulse width modulation (PWM) coil to reduce power for keeping the contacts closed. Sealed contacts help ensure there is no leakage of electrical arc for safety. The high-current relay's permanent magnets blow out the magnetic field horizontally to achieve a rapid extinguishing of the DC arc.

The DCNHR Series contactor relay is available for 20A to 300A contact switching as well as with and without polarized contacts to suit the polarity of your application.

Applications

- Battery electric vehicles
- Hybrid electric vehicles
- Electric maintenance vehicles
- Industrial applications

Features and Benefits

- Available with 20A to 300A contact switching capability
- Up to 500A continuous current using 400MCM cable
- Available with normally open or normally closed auxiliary contact
- Normally open relay design
- Resin housing provides corrosion resistance in harsh automotive environments
- Sealed contacts with no leakage of electrical arc for maximum safety
- Built-in energy-saving coil to reduce the coil holding power consumption
- RoHS compliant
- Available with mechanically linked auxiliary contacts

Web Resources

Download 2D print, installation guide and technical resources at: littelfuse.com/DCNHR

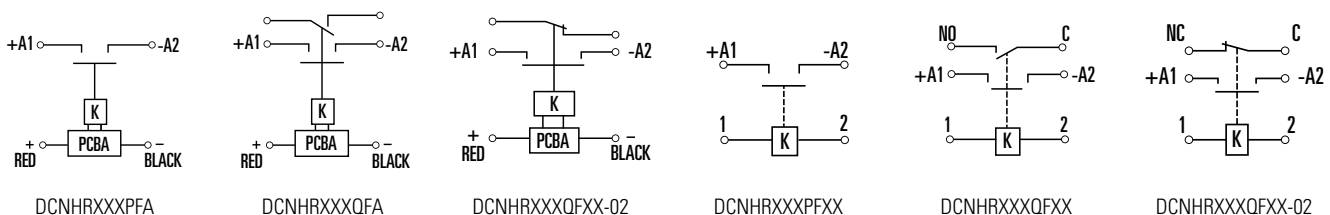

Electrical Diagrams



DCNHR Series

900V DC Max Contactor Relays

Ordering Information

PART NUMBER	CONTINUOUS CURRENT (A)	CABLE/CONNECTOR SIZE	VOLTAGE RATING		MOUNTING	COIL VOLTAGE (V DC)	COIL TYPE	AUX CONTACT	POLARIZED	2D PRINT
			SYSTEM NOMINAL (V DC)	MAX VOLTAGE (V DC)						
DCNHR20PF12 *	20	16AWG	450	900	BOTTOM	12	Single	No	Yes	
DCNHR20PF24 *	20	16AWG	450	900	BOTTOM	24	Single	No	Yes	
DCNHR20PF48 *	20	16AWG	450	900	BOTTOM	48	Single	No	Yes	
DCNHR30PF12 *	30	14AWG	450	900	BOTTOM	12	Single	No	Yes	
DCNHR30PF24 *	30	14AWG	450	900	BOTTOM	24	Single	No	Yes	
DCNHR30PF48 *	30	14AWG	450	900	BOTTOM	48	Single	No	Yes	
DCNHR40PF12 *	40	12AWG	450	900	BOTTOM	12	Single	No	Yes	
DCNHR40PF24 *	40	12AWG	450	900	BOTTOM	24	Single	No	Yes	
DCNHR40PF48 *	40	12AWG	450	900	BOTTOM	48	Single	No	Yes	
DCNHR50PF12	50	10AWG	450	900	BOTTOM	12	Single	No	Yes	
DCNHR50PF24	50	10AWG	450	900	BOTTOM	24	Single	No	Yes	
DCNHR50PF48	50	10AWG	450	900	BOTTOM	48	Single	No	Yes	
DCNHR50QF12	50	10AWG	450	900	BOTTOM	12	Single	Yes +	Yes	
DCNHR50QF24	50	10AWG	450	900	BOTTOM	24	Single	Yes +	Yes	
DCNHR50QF48	50	10AWG	450	900	BOTTOM	48	Single	Yes +	Yes	
DCNHR100PF12	100	6AWG	450	900	BOTTOM	12	Single	No	Yes	
DCNHR100PF24	100	6AWG	450	900	BOTTOM	24	Single	No	Yes	
DCNHR100PF48	100	6AWG	450	900	BOTTOM	48	Single	No	Yes	
DCNHR100QF12	100	6AWG	450	900	BOTTOM	12	Single	Yes +	Yes	
DCNHR100QF24	100	6AWG	450	900	BOTTOM	24	Single	Yes +	Yes	
DCNHR100QF48	100	6AWG	450	900	BOTTOM	48	Single	Yes +	Yes	
DCNHR150PFA	150	2AWG	450	900	BOTTOM	9~36	PWM	No	Yes	
DCNHR150QFA	150	2AWG	450	900	BOTTOM	9~36	PWM	Yes +	Yes	
DCNHR200PFA	200	0AWG	450	900	BOTTOM	9~36	PWM	No	Yes	
DCNHR200QFA	200	0AWG	450	900	BOTTOM	9~36	PWM	Yes +	Yes	
DCNHR250PFA	250	00AWG	450	900	BOTTOM	9~36	PWM	No	Yes	
DCNHR250QFA	250	00AWG	450	900	BOTTOM	9~36	PWM	Yes +	Yes	
DCNHR300PFA	300 500	000AWG 400MCM	450	900	BOTTOM	9~36	PWM	No	Yes	
DCNHR300QFA	300 500	000AWG 400MCM	450	900	BOTTOM	9~36	PWM	Yes +	Yes	

* For main contacts terminals with internal thread, add '-01' to suffix of part number
+ For normally-closed Aux, add suffix -02. If no -02, aux will be normally-open.

DCNHR Series

900V DC Max Contactor Relays

Performance Data

MAIN CONTACT		
Contact Arrangement	SPST NO	
Max Short Circuit Current	DCNHR20PF12, DCNHR20PF24 DCNHR20PF48	100A @ 450V DC
	DCNHR30PF12, DCNHR30PF24 DCNHR30PF48	150A @ 450V DC
	DCNHR40PF12, DCNHR40PF24 DCNHR40PF48, DCNHR50PF12 DCNHR50PF24, DCNHR50PF48 DCNHR50QF12, DCNHR50QF24 DCNHR50QF48	200A @ 450V DC
	DCNHR100PF12, DCNHR100PF24 DCNHR100PF48, DCNHR100QF12 DCNHR100QF24, DCNHR100QF48	400A @ 450V DC
	DCNHR150PFA, DCNHR150QFA DCNHR200PFA, DCNHR200QFA DCNHR250PFA, DCNHR250QFA DCNHR300PFA, DCNHR300QFA	2000A @ 320V DC
Dielectric Withstand Voltage	2200V AC	
Insulation Resistance	≥ 100MΩ @ 500V DC	

COIL DATA					
Voltage Rating (V DC)	12	24	48	9-36	
Pickup Voltage @ 25°C (V DC MAX)	DCNHR20, DCNHR30 DCNHR40	9	18	36	/
	DCNHR50, DCNHR100	8.4	16.8	33.6	/
	DCNHR150, DCNHR200 DCNHR250, DCNHR300	/	/	/	9
Dropout Voltage @ 25°C (V DC MIN)	DCNHR20, DCNHR30 DCNHR40	1	2	4	/
	DCNHR50, DCNHR100	1	2	4	/
	DCNHR150, DCNHR200 DCNHR250, DCNHR300	/	/	/	6
Hold Current (A)	DCNHR20, DCNHR30 DCNHR40	0.3	0.15	0.073	/
	DCNHR50, DCNHR100	0.51	0.26	0.13	/
	DCNHR150, DCNHR200 DCNHR250, DCNHR300	/	/	/	0.25@12V DC
Coil Watts @ 25°C (W)	DCNHR20, DCNHR30 DCNHR40	3.5	3.5	3.5	/
	DCNHR50, DCNHR100	6.5	6.5	6.5	/
	DCNHR150, DCNHR200 DCNHR250, DCNHR300	/	/	/	Start Up/Hold 45/3

LIFE	
Electrical Life	Please See Make Break Chart
Mechanical Life	200,000

Note: rated at continuous current rating and system nominal voltage

OPERATE / RELEASE TIME	
Close (ms)	25
Release (ms)	12

ENVIRONMENTAL DATA		
Shock	Shock, 11ms ½ Sine, Peak, Operating 20G	
Vibration	DCNHR20, DCNHR30 DCNHR40	5.69G, 10-2000Hz
	DCNHR50, DCNHR100, DCNHR150, DCNHR200 DCNHR250, DCNHR300	Vibration, Sine, 80-2000Hz., Peak 20G
Operating Ambient Temperature	-40°C~+85°C	
Weight (g)	DCNHR20, DCNHR30 DCNHR40	122.3
	DCNHR50, DCNHR100	198
	DCNHR150, DCNHR200 DCNHR250, DCNHR300	398

AUX CONTACTS	
Contact Arrangement	Normally open or normally closed
Max. Rating	2A @ 24V DC
Min. Rating	0.1A @ 5V DC
Max. Resistance	≤500mΩ

DCNHR Series

900V DC Max Contactor Relays

Estimated Make Break Chart
DCNHR20 / DCNHR30 / DCNHR40

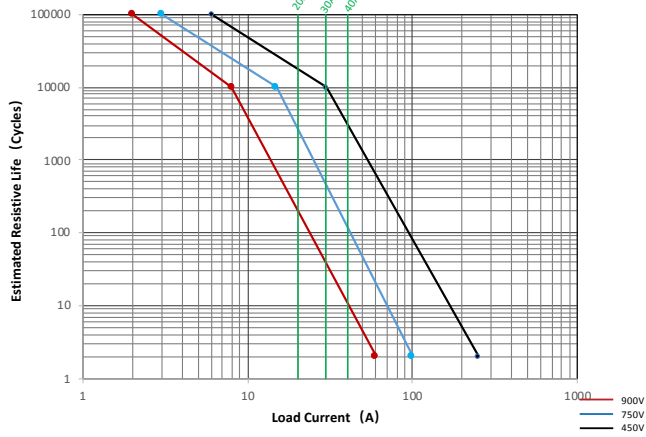

Carry Current vs Time at 65°C Chart
DCNHR20 / DCNHR30 / DCNHR40

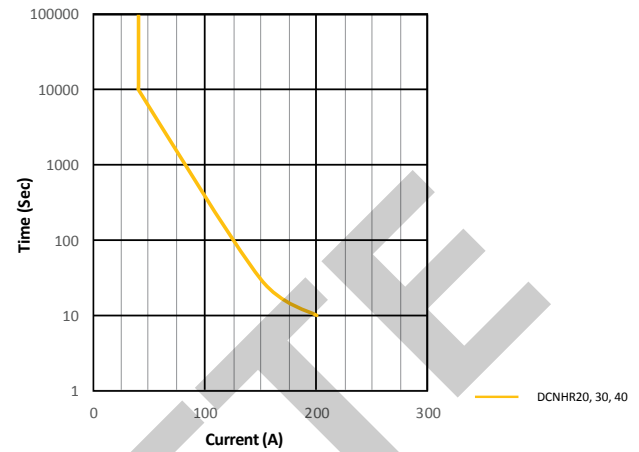

DCNHR50 / DCNHR100

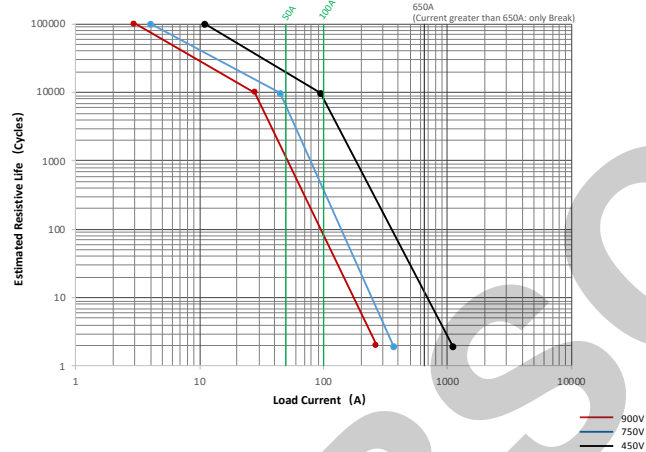

DCNHR50 / DCNHR100

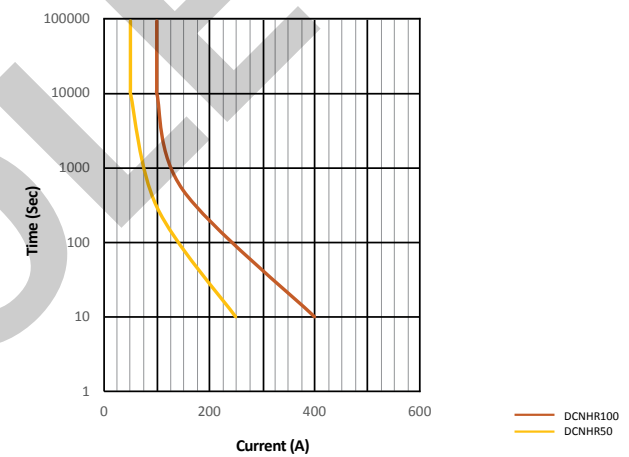

DCNHR150 / DCNHR200 / DCNHR250 / DCNHR300

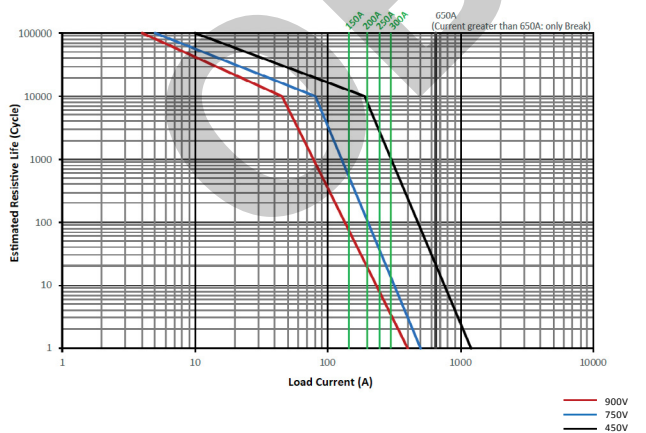

DCNHR150 / DCNHR200 / DCNHR250 / DCNHR300

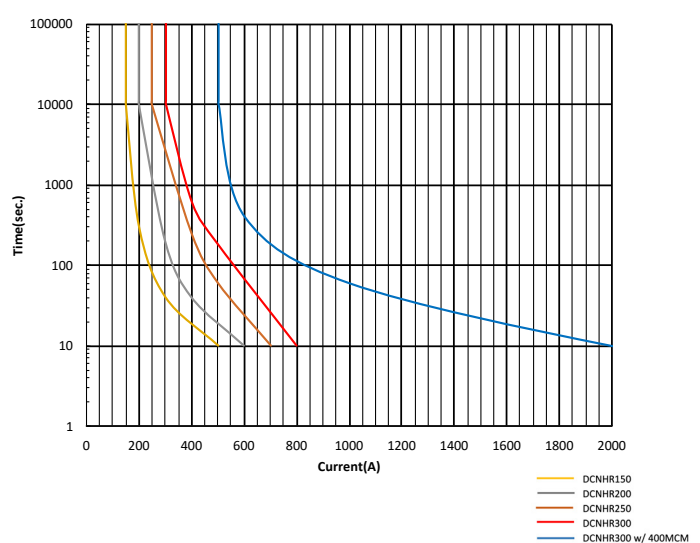

Note: Electrical life rating is based on resistive load with 27μH maximum inductance in circuit. Because your application may be different, we suggest you test the contactor in your circuit to verify life is as required.

DCNHR Series

900V DC Max Contactor Relays

Part Number System

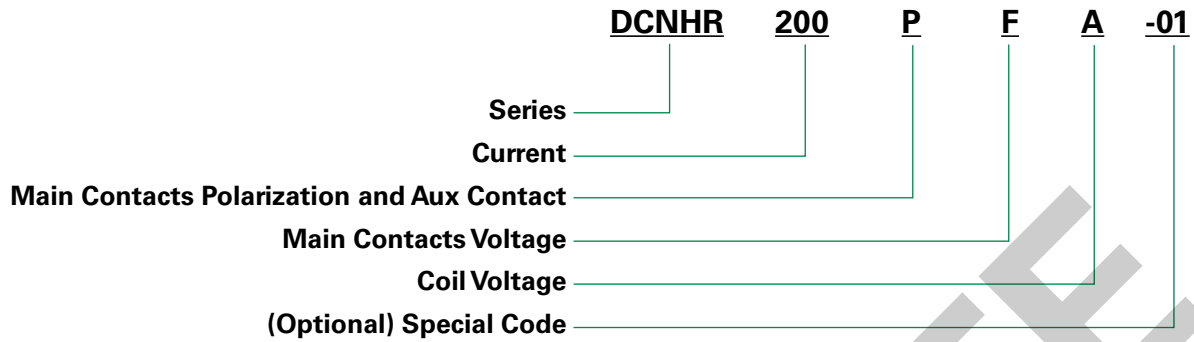

MAIN CONTACTS POLARIZATION AND AUX CONTACT		
	POLARIZED?	INCLUDE AUX CONTACT?
P:	Yes	No
Q:	Yes	Yes

MAIN CONTACT TEST VOLTAGE		
F:	450	V DC

COIL VOLTAGE		
12:	12	V DC
24:	24	V DC
48:	48	V DC
A:	9 ~ 36	V DC

SPECIAL CODE	
-01	Internal threads for 20A, 30A & 40A
-02	Normally closed aux for 50A, 100A, 150A, 200A, 250A & 300A

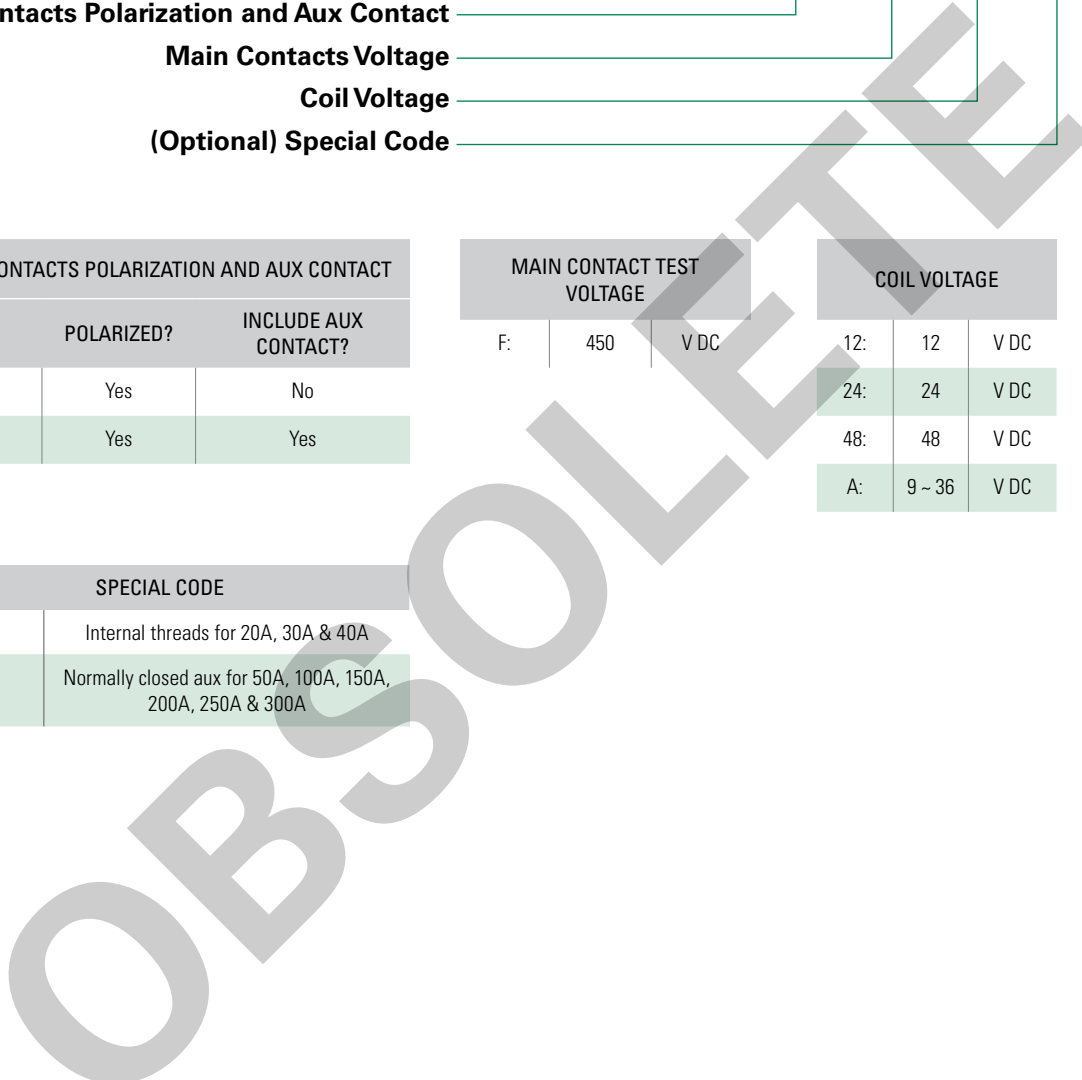

DCNHR Series

900V DC Max Contactor Relays

- Be sure to use a washer to prevent screws from loosening. Tighten the screw so that the torque is in the range specified below. Exceeding the maximum torque can lead to product rupture. See the chart below.
- Please refer to the drawing for connection polarity.
- Do not use dropped products.
- Improper assembly of a polarized contaminator can reduce life.
- Avoid installing the product in a strong magnetic field (Close to the transformer or magnet), or near an object with heat radiation.
- Electrical life
Please use under load capability and life cycle so as not to cause a function failure. (Please also treat the contactor as a

product with specified life and replace it when necessary). It is possible to make parts burn around the contactor once operating failure happens. So it is necessary to take layout into account to make sure power shall be cut off within 1 second.

- Lifetime of internal gas diffusion
The contactor is sealed and filled with gas, lifetime of gas diffusion is determined by temperature in contact chamber (Ambient temperature + Temperature rising by contact energizing). Therefore environment temperature should be from -40 to +85°C.
- Do not let particle and oil stain on the main terminal with which the load shall make a reliable contact or it will cause a lot of heat.

PRODUCT SERIES	PRODUCT MODEL	CONTACT TERMINAL		COIL TERMINAL		MOUNTING	
		HOLE OR BOLT	REFERENCE TORQUE	HOLE/BOLT/WIRE/TERMINAL	REFERENCE TORQUE	REFERENCE BOLT SIZE	REFERENCE TORQUE
DCNHR20PF	DCNHR20PF12	Bolt : M5	1.7-2.0N.m	Wire: UL1332 22 AWG	/	M4	1.8-2.3N.m
	DCNHR20PF24						
	DCNHR20PF48						
DCNHR20PF	DCNHR20PF12-01	Hole : M4	1.5-1.8N.m	Wire: UL1332 22 AWG	/	M4	1.8-2.3N.m
	DCNHR20PF24-01						
	DCNHR20PF48-01						
DCNHR30PF	DCNHR30PF12	Bolt : M5	1.7-2.0N.m	Wire: UL1332 22 AWG	/	M4	1.8-2.3N.m
	DCNHR30PF24						
	DCNHR30PF48						
DCNHR30PF	DCNHR30PF12-01	Hole : M4	1.5-1.8N.m	Wire: UL1332 22 AWG	/	M4	1.8-2.3N.m
	DCNHR30PF24-01						
	DCNHR30PF48-01						
DCNHR40PF	DCNHR40PF12	Bolt : M5	1.7-2.0N.m	Wire: UL1332 22 AWG	/	M4	1.8-2.3N.m
	DCNHR40PF24						
	DCNHR40PF48						
DCNHR40PF	DCNHR40PF12-01	Hole : M4	1.5-1.8N.m	Wire: UL1332 22 AWG	/	M4	1.8-2.3N.m
	DCNHR40PF24-01						
	DCNHR40PF48-01						
DCNHR100	DCNHR50QF12	Hole: M5	3-4N.m	Wire: UL1332 22 AWG	/	M4	1.7-2.5N.m
	DCNHR50QF24						
	DCNHR50QF48						
	DCNHR50PF12						
	DCNHR50PF24						
	DCNHR50PF48						
	DCNHR100QF12						
	DCNHR100QF24						
	DCNHR100QF48						
	DCNHR100PF12						
DCNHR100PF24							
DCNHR100PF48							
DCNHR150	DCNHR150PFA DCNHR150QFA	Bolt : M8	8-12N.m	Wire: UL3321 22 AWG	/	M5	1.8-3.5N.m
DCNHR200	DCNHR200PFA DCNHR200QFA						
DCNHR250	DCNHR250PFA DCNHR250QFA						
DCNHR300	DCNHR300PFA DCNHR300QFA				/		