

# SVxx12xxQ series

## 12 Amp High Junction Temperature SCRs

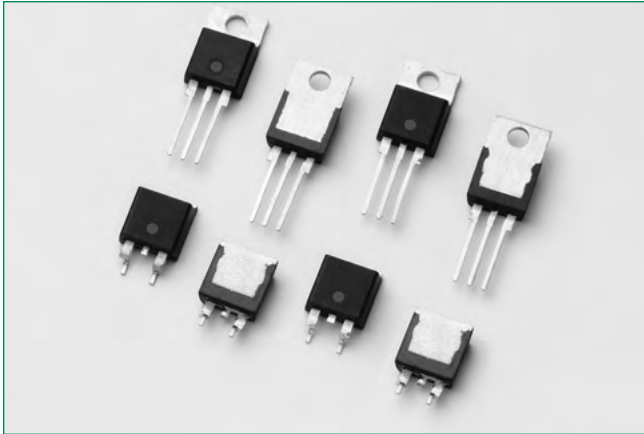

### Agency Approval

Agency	Agency File Number
	E71639*

\*L Packages only

### Main Features

Symbol	Value	Unit
$I_{T(RMS)}$	12	A
$V_{DRM}/V_{RRM}$	600	V
$I_{GT}$	6 to 10	mA

### Schematic Symbol

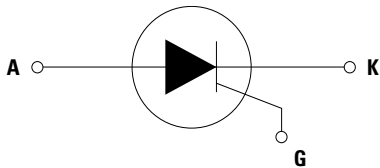

### Description

The SVxx12xxQ high junction temperature SCR series is ideal for uni-directional switch applications such as phase control in heating, motor speed controls, converters/rectifiers, inrush current control and capacitive discharge ignitions.

These SCRs have a low gate current, (IGT) trigger level of 6mA and 10mA maximum at approximately 1.5V for SVxx12x1Q and SVxx12x2Q, respectively.

### Features & Benefits

- Halogen-free and RoHS compliant
- 150°C maximum junction temperature
- Surge capability up to 120 A at 60 Hz half cycle
- High dv/dt performance
- Low turn off time
- Recognized to UL 1557 as an Electrically Isolated Semiconductor Device

### Applications

Typical applications include AC Generator (ACG) rectifiers, battery voltage regulators and generic converters and inrush current controller in various AC to DC applications. Additional applications include controls for power tools, home/brown good and white goods appliances.

Internally constructed isolated packages offered for ease of heat sinking with high isolation voltage.

# SVxx12xxQ series

## 12 Amp High Junction Temperature SCRs

### Absolute Maximum Ratings

Symbol	Parameter	Test Conditions	Value	Unit
$V_{DSM}/V_{RSM}$	Peak non-repetitive blocking voltage	$P_W = 100 \mu s$	800	V
$I_{T(RMS)}$	RMS on-state current	SVxx12LxQ SVxx12RxQ SVxx12NxQ	$T_C = 110^\circ C$ $T_C = 135^\circ C$	12 A
$I_{T(AV)}$	Average on-state current	SVxx12LxQ SVxx12RxQ SVxx12NxQ	$T_C = 110^\circ C$ $T_C = 135^\circ C$	7.6 A
$I_{TSM}$	Peak non-repetitive surge current (single half cycle, $T_J$ (initial) = $25^\circ C$ )		$f = 50Hz$ $f = 60Hz$	150 180 A
$I^2t$	$I^2t$ Value for fusing		$t_p = 8.3 ms$	135 A <sup>2</sup> s
di/dt	Critical rate of rise of on-state current	$f = 60Hz; T_J = 150^\circ C$	100	A/ $\mu s$
$I_{GM}$	Peak gate current	$T_J = 150^\circ C$	4	A
$P_{G(AV)}$	Average gate power dissipation	$T_J = 150^\circ C$	0.8	W
$T_{stg}$	Storage temperature range		-40 to 150	$^\circ C$
$T_J$	Operating junction temperature range		-40 to 150	$^\circ C$

Note: xx=voltage/10, x=sensitivity

### Electrical Characteristics ( $T_J = 25^\circ C$ , unless otherwise specified)

Symbol	Test Conditions		SVxx12x1Q	SVxx12x2Q	Unit
$I_{GT}$	$V_D = 12V R_L = 60 \Omega$	MAX.	6	10	mA
		MIN.	2	5	
$V_{GT}$	$V_D = 12V R_L = 60 \Omega$	MAX.	1.5	1.5	V
dv/dt	$V_D = 67\% V_{DRM};$ gate open; $T_J = 125^\circ C$	MIN.	400	800	V/ $\mu s$
	$V_D = 67\% V_{DRM};$ gate open; $T_J = 150^\circ C$		200	400	
$V_{GD}$	$V_D = V_{DRM} R_L = 3.3 k\Omega T_J = 150^\circ C$	MIN.	0.2	0.2	V
$I_H$	$I_T = 200mA$ (initial)	MAX.	25	40	mA
$t_q$	$I_T = 2A; t_p = 50\mu s; dv/dt = 5V/\mu s; di/dt = 30A/\mu s$	MAX.	12	12	$\mu s$
$t_{gt}$	$I_G = 2 \times I_{GT} P_W = 15\mu s I_T = 24A$	TYP.	2.6	2.6	$\mu s$

### Static Characteristics

Symbol	Test Conditions	Value	Unit
$V_{TM}$	$I_T = 24A; t_p = 380 \mu s$	MAX.	1.65 V
$I_{DRM} / I_{RRM}$	$V_{DRM} = V_{RRM}$	MAX.	$T_J = 25^\circ C$ 10 $T_J = 125^\circ C$ 500 $T_J = 150^\circ C$ 2000 $\mu A$

### Thermal Resistances

Symbol	Parameter	Value	Unit
$R_{\theta(JC)}$	Junction to case (AC)	SVxx12LxQ	2.5
		SVxx12RxQ	1.1
		SVxx12NxQ	

Note: xx=voltage/10, x=sensitivity

# SVxx12xxQ series

## 12 Amp High Junction Temperature SCRs

**Figure 1:**  
Normalized DC Gate Trigger Current vs. Junction Temperature

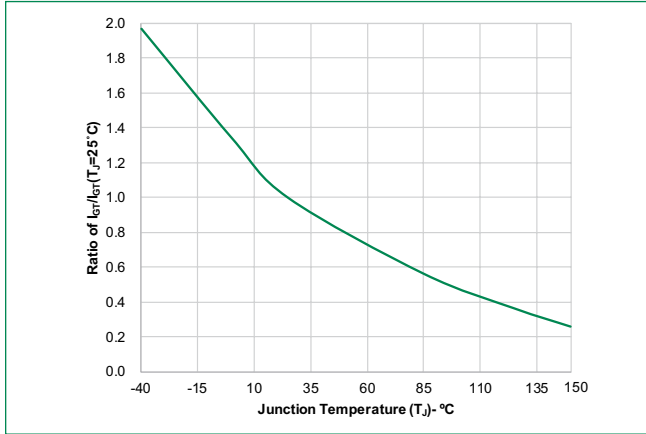

**Figure 2:**  
Normalized DC Gate Trigger Voltage vs. Junction Temperature

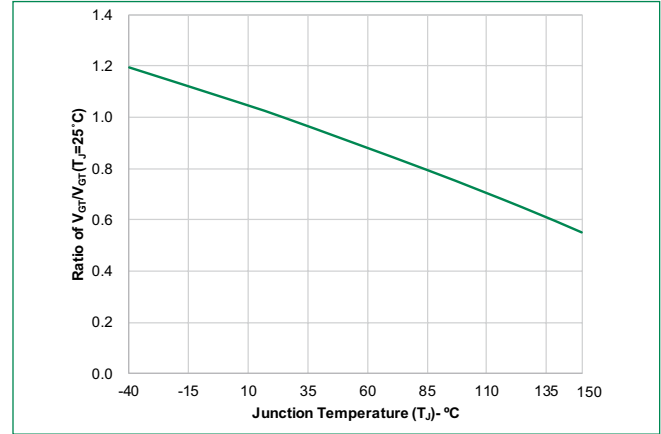

**Figure 3:**  
Normalized DC Holding Current vs. Junction Temperature

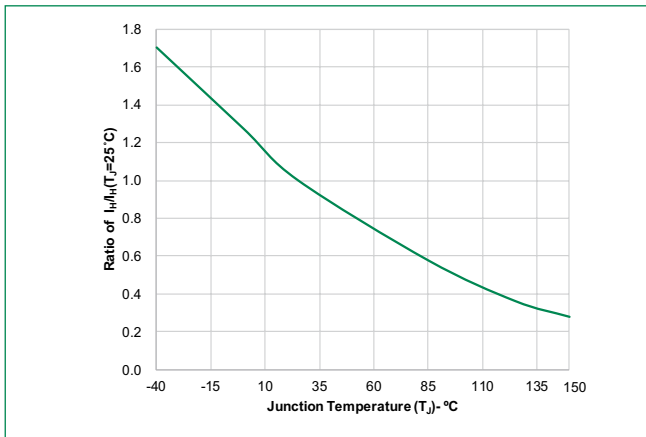

**Figure 4:**  
On-State Current vs. On-State Voltage (Typical)

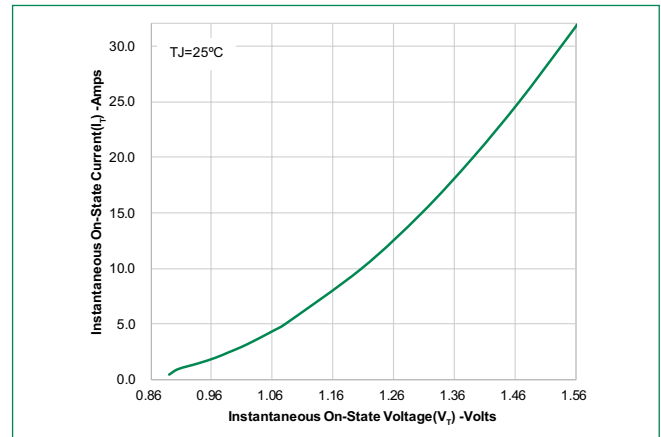

**Figure 5:**  
Power Dissipation (Typical) vs. RMS On-State Current

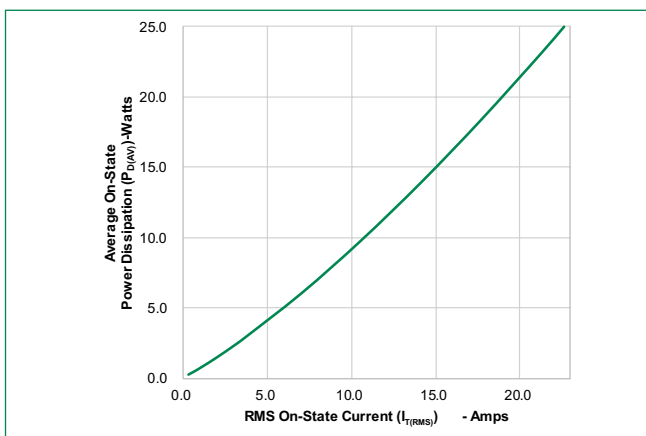

**Figure 6:**  
Maximum Allowable Case Temperature vs. RMS On-State Current

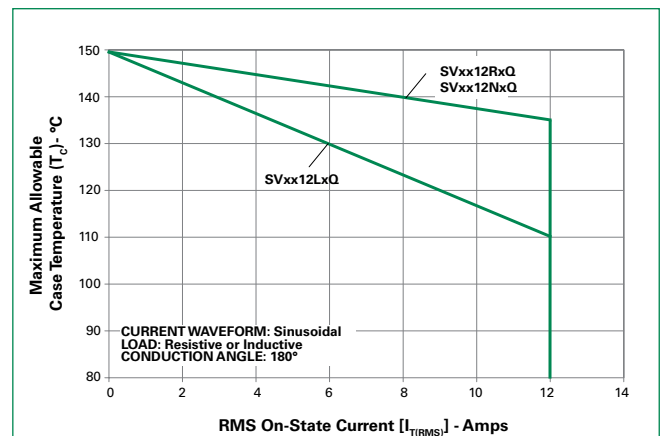

# SVxx12xxQ series

## 12 Amp High Junction Temperature SCRs

**Figure 7:**  
Maximum Allowable Case Temperature v s. Average On-State Current

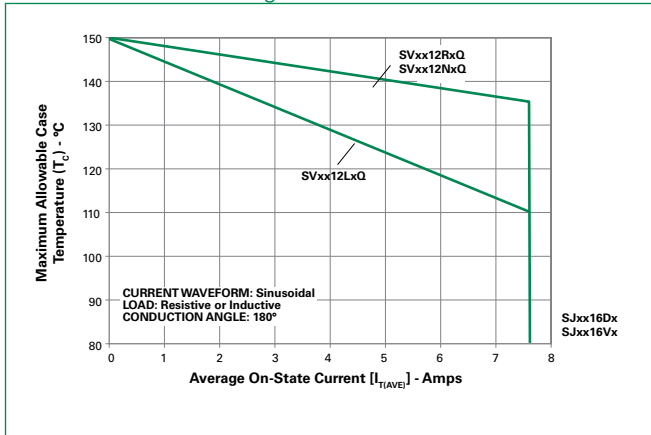

**Figure 8:**  
Peak Capacitor Discharge Current

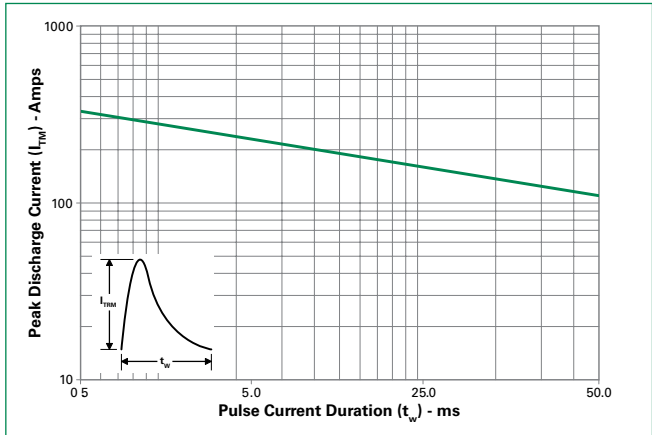

**Figure 9:**  
Peak Capacitor Discharge Current Derating

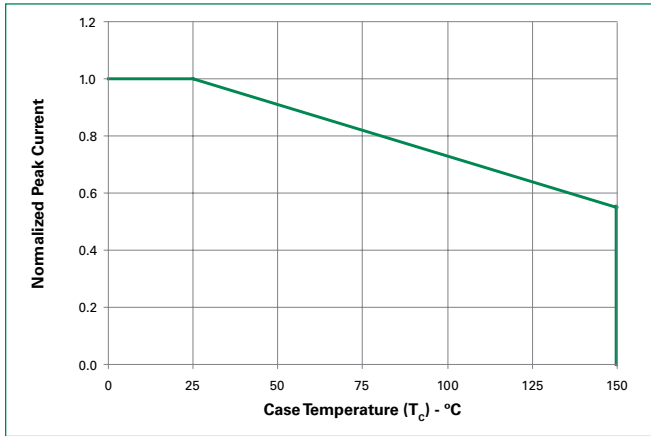

**Figure 10:** Surge Peak On-State Current vs. Number of Cycles

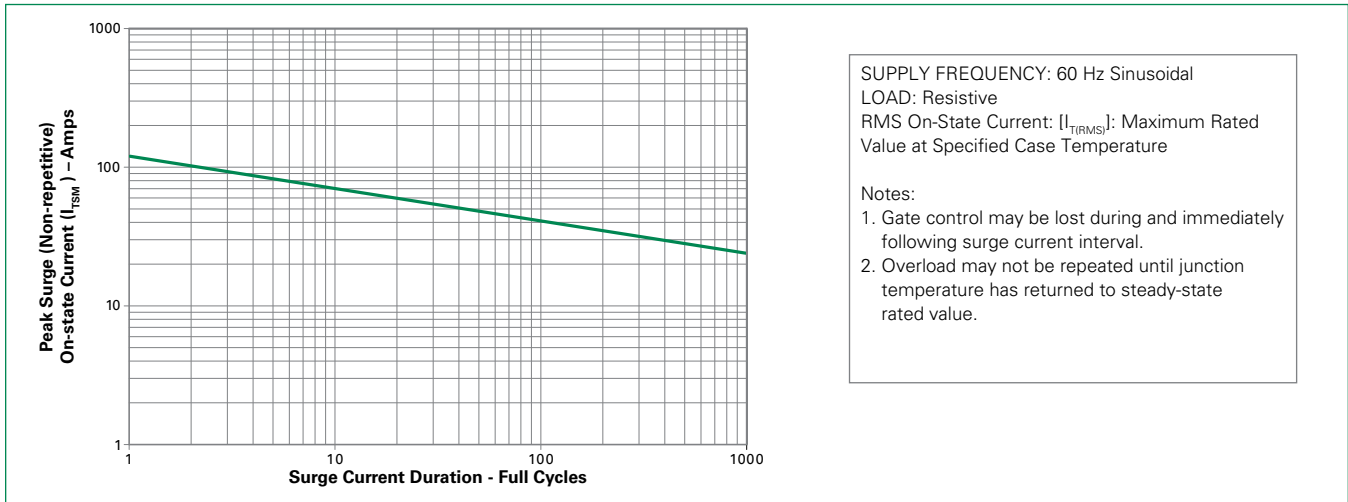

# SVxx12xxQ series

## 12 Amp High Junction Temperature SCRs

### Soldering Parameters

<b>Reflow Condition</b>		Pb – Free assembly
<b>Pre Heat</b>	- Temperature Min ( $T_{s(min)}$ )	150°C
	- Temperature Max ( $T_{s(max)}$ )	200°C
	- Time (min to max) ( $t_s$ )	60 – 180 secs
<b>Average ramp up rate (Liquidus Temp) (<math>T_L</math>) to peak</b>		5°C/second max
<b><math>T_{s(max)}</math> to <math>T_L</math> - Ramp-up Rate</b>		5°C/second max
<b>Reflow</b>	- Temperature ( $T_L$ ) (Liquidus)	217°C
	- Time ( $t_L$ )	60 – 150 seconds
<b>Peak Temperature (<math>T_p</math>)</b>		260 <sup>+0/-5</sup> °C
<b>Time within 5°C of actual peak Temperature (<math>t_p</math>)</b>		20 – 40 seconds
<b>Ramp-down Rate</b>		5°C/second max
<b>Time 25°C to peak Temperature (<math>T_p</math>)</b>		8 minutes Max.
<b>Do not exceed</b>		280°C

### Physical Specifications

<b>Terminal Finish</b>	100% Matte Tin-plated
<b>Body Material</b>	UL Recognized compound meeting flammability rating V-0
<b>Lead Material</b>	Copper Alloy

### Design Considerations

Careful selection of the correct component for the application's operating parameters and environment will go a long way toward extending the operating life of the Thyristor. Good design practice should limit the maximum continuous current through the main terminals to 75% of the component rating. Other ways to ensure long life for a power discrete semiconductor are proper heat sinking and selection of voltage ratings for worst case conditions. Overheating, overvoltage (including  $dv/dt$ ), and surge currents are the main killers of semiconductors. Correct mounting, soldering, and forming of the leads also help protect against component damage.

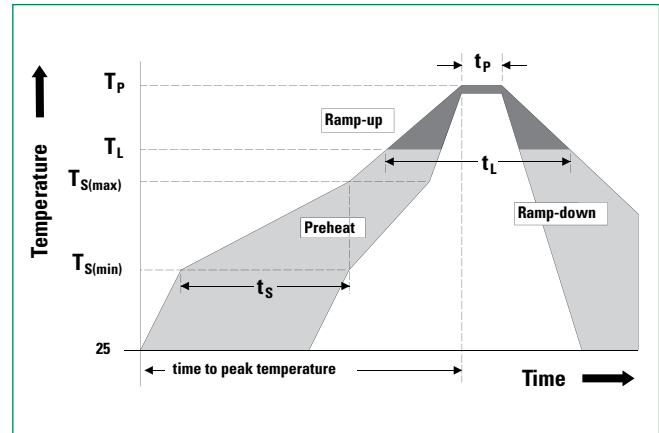

### Environmental Specifications

Test	Specifications and Conditions
<b>AC Blocking</b>	MIL-STD-750, M-1040, Cond A Applied Peak AC voltage @ 150°C for 1008 hours
<b>Temperature Cycling</b>	MIL-STD-750, M-1051, 1000 cycles; -55°C to +150°C; 15-min dwell-time
<b>Temperature/Humidity</b>	EIA / JEDEC, JESD22-A101 1008 hours; 160V - DC: 85°C; 85% rel humidity
<b>Resistance to Solder Heat</b>	MIL-STD-750 Method 2031
<b>Solderability</b>	ANSI/J-STD-002, category 3, Test A
<b>Lead Bend</b>	MIL-STD-750, M-2036 Cond E
<b>Moisture Sensitivity Level</b>	Level 1, JEDEC-J-STD-020D

# SVxx12xxQ series

## 12 Amp High Junction Temperature SCRs

### Dimensions – TO-220AB (L-Package) – Isolated Mounting Tab

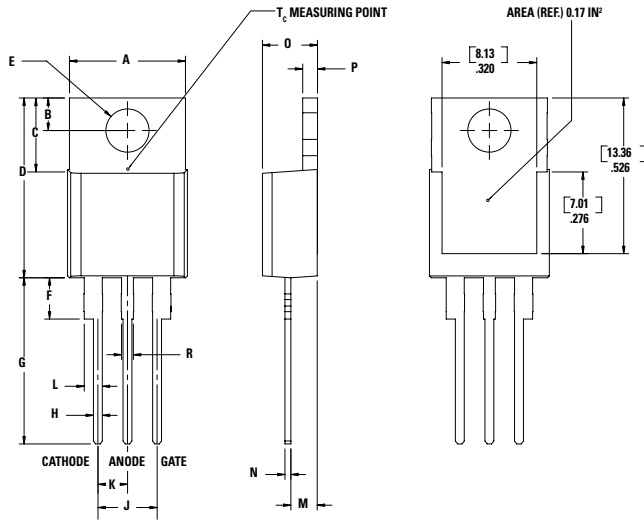

Dimension	Inches		Millimeters	
	Min	Max	Min	Max
A	0.380	0.420	9.65	10.67
B	0.105	0.115	2.67	2.92
C	0.230	0.250	5.84	6.35
D	0.590	0.620	14.99	15.75
E	0.142	0.147	3.61	3.73
F	0.110	0.130	2.79	3.30
G	0.540	0.575	13.72	14.61
H	0.025	0.035	0.64	0.89
J	0.195	0.205	4.95	5.21
K	0.095	0.105	2.41	2.67
L	0.060	0.075	1.52	1.91
M	0.085	0.095	2.16	2.41
N	0.018	0.024	0.46	0.61
O	0.178	0.188	4.52	4.78
P	0.045	0.060	1.14	1.52
R	0.038	0.048	0.97	1.22

### Dimensions – TO-220AB (R-Package) – Non-Isolated Mounting Tab Common with Center Lead

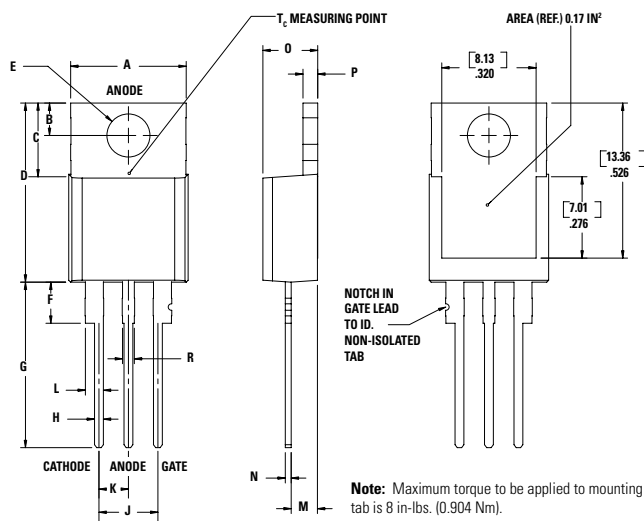

Dimension	Inches		Millimeters	
	Min	Max	Min	Max
A	0.380	0.420	9.65	10.67
B	0.105	0.115	2.67	2.92
C	0.230	0.250	5.84	6.35
D	0.590	0.620	14.99	15.75
E	0.142	0.147	3.61	3.73
F	0.110	0.130	2.79	3.30
G	0.540	0.575	13.72	14.61
H	0.025	0.035	0.64	0.89
J	0.195	0.205	4.95	5.21
K	0.095	0.105	2.41	2.67
L	0.060	0.075	1.52	1.91
M	0.085	0.095	2.16	2.41
N	0.018	0.024	0.46	0.61
O	0.178	0.188	4.52	4.78
P	0.045	0.060	1.14	1.52
R	0.038	0.048	0.97	1.22

# SVxx12xxQ series

## 12 Amp High Junction Temperature SCRs

### Dimensions – TO- 263AB (N-package) – D2-Pak Surface Mount

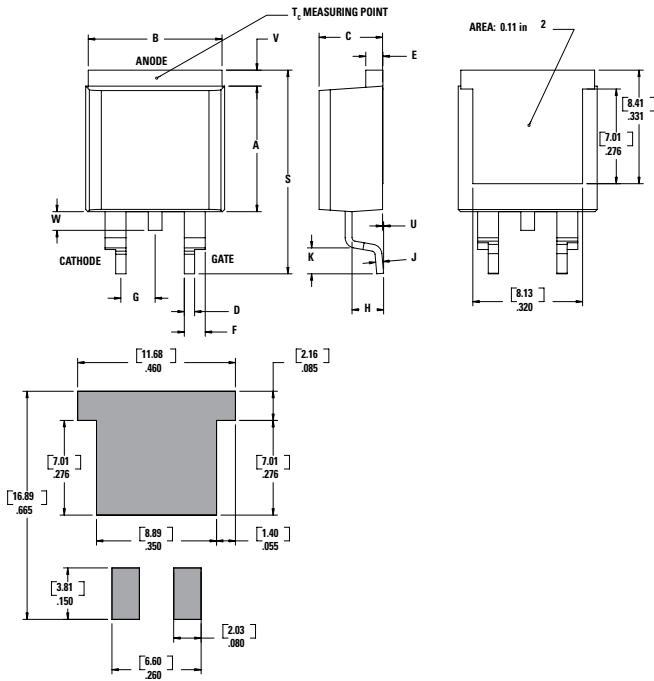

Dimension	Inches		Millimeters	
	Min	Max	Min	Max
A	0.360	0.370	9.14	9.40
B	0.380	0.420	9.65	10.67
C	0.178	0.188	4.52	4.78
D	0.025	0.035	0.64	0.89
E	0.045	0.060	1.14	1.52
F	0.060	0.075	1.52	1.91
G	0.095	0.105	2.41	2.67
H	0.092	0.102	2.34	2.59
J	0.018	0.024	0.46	0.61
K	0.090	0.110	2.29	2.79
S	0.590	0.625	14.99	15.88
V	0.035	0.045	0.89	1.14
U	0.002	0.010	0.05	0.25
W	0.040	0.070	1.02	1.78

### Product Selector

Part Number	Voltage	Gate Sensitivity	Type	Package
	600V			
SVxx12L1Q	X	6mA	Standard SCR	TO-220L
SVxx12R1Q	X	6mA	Standard SCR	TO-220R
SVxx12N1Q	X	6mA	Standard SCR	TO-263
SVxx12L2Q	X	10mA	Standard SCR	TO-220L
SVxx12R2Q	X	10mA	Standard SCR	TO-220R
SVxx12N2Q	X	10mA	Standard SCR	TO-263

Note: xx = Voltage/10

### Packing Options

Part Number	Marking	Weight	Packing Mode	Base Quantity
SVxx12LxQTP	SVxx12LxQ	2.2g	Tube	1000 (50 per tube)
SVxx12RxQTP	SVxx12RxQ	2.2g	Tube	1000 (50 per tube)
SVxx12NxQTP	SVxx12NxQ	1.6g	Tube	1000 (50 per tube)
SVxx12NxQRP	SVxx12NxQ	1.6g	Embossed Carrier	500

Note: xx=voltage/10, x=sensitivity

# SVxx12xxQ series

## 12 Amp High Junction Temperature SCRs

### Part Numbering System

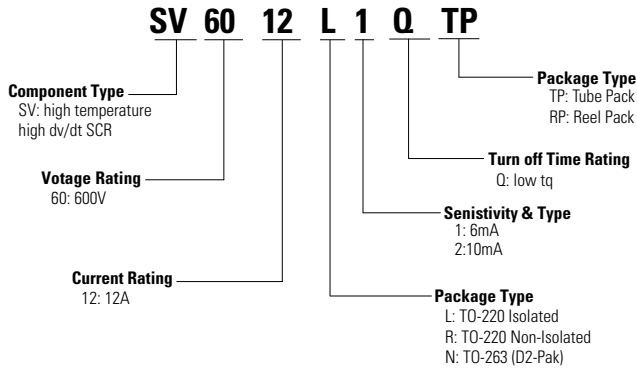

### Part Marking System

T0-220 AB - (L and R Package)  
T0-263 AB - (N Package)

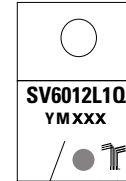

**Date Code Marking**  
Y: Year Code  
M: Month Code  
XXX: Lot Trace Code

### TO-263 Embossed Carrier Reel Pack (RP) Specifications

Meets all EIA-481-2 Standards

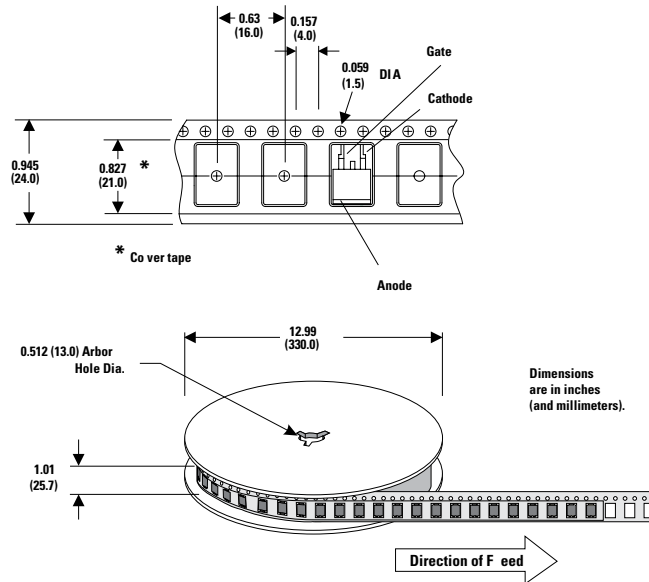

**Disclaimer Notice** - Information furnished is believed to be accurate and reliable. However, users should independently evaluate the suitability of and test each product selected for their own applications. Littelfuse products are not designed for, and may not be used in, all applications. Read complete Disclaimer Notice at <http://www.littelfuse.com/disclaimer-electronics>.