



**Description**

PLED Series open LED protectors provide a switching electronic shunt path when an LED in an LED string fails as an open circuit. This ensures that the remaining string of LEDs will continue to function if a single LED does not.

PLED Series devices were designed to enable higher reliability in outdoor LED lighting applications such as street lighting, outdoor signage, aircraft runway lighting, roadside warning lights and other applications.

Compatible with one, two and three watt LEDs that have a nominal 3V forward characteristic, PLED Series devices are available in two surface mount packages, the DO-214 and the Quad Flat Pak No-lead (QFN). The QFN's low profile, chip scale package (CSP) is ideal for dense board applications.

**Agency Approvals**

Agency	Agency File Number
	E133083

**Features & Benefits**

- Fast switching
- Automatically resets after power cycle
- Available in low profile, small footprint QFN and Standard DO214AA packages
- Compatible with industrial lighting environments
- Compatible with PWM frequencies up to 30 kHz
- RoHS-Compliant and Halogen-Free

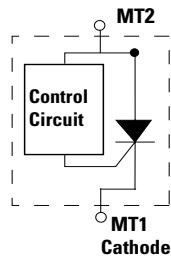

**Schematic Symbol**



**Electrical Characteristics** (All parameters are measured at T=25°C unless otherwise noted)

Part Number	Marking	V <sub>BR</sub> Breakdown		V <sub>DRM</sub> breakdown	I <sub>H</sub>	I <sub>S</sub>	I <sub>T</sub> @V <sub>T</sub>	V <sub>T</sub> @ I <sub>T</sub> = 1 Amp	Critical rate of rise dV/dt
		Volts		Volts	mAmps	mAmps	Amps	Volts	Volts
		Min	Max	Min	Min	Max	Max	Max	Max
PLED6Q12	PL6	6	16	6	5	100	1.0	1.2	250V/μs
PLED6S	PL6								
PLED9Q12	PL9	9	18	9					
PLED9S	PL9								
PLED13Q12	PL13	13	26	13					
PLED13S	PL13								
PLED18Q12	PL18	18	33	18					
PLED18S	PL18								

### Thermal Considerations

Package	Symbol	Parameter	Value	Unit
 	$T_J$	Operating Junction Temperature Range	-40 to +150	°C
	$T_S$	Storage Temperature Range	-65 to +150	°C
	$R_{\theta JA}$	Thermal Resistance: Junction to Ambient	DO-214: 90 <sup>1</sup> DO-214: 40 <sup>2</sup> QFN: 120 <sup>1</sup> QFN: 60 <sup>3</sup>	°C/W

**Notes:**

1) Standard FR-4 PCB with Copper Pads (Recommended Size)  
 2) Aluminum PCB  
 Thickness: 1.6mm  
 Grade: 1-2 W/mK Thermal Conductivity  
 Trace thickness: 2 oz  
 Insulation layer thickness: 215 um  
 Solder Pad Dimensions: 2.0mm x 2.8mm (Recommended Size)

3) Aluminum PCB  
 Thickness: 1.6mm  
 Grade: 1-2 W/mK Thermal Conductivity  
 Trace thickness: 2 oz  
 Insulation layer thickness: 60 um  
 Solder Pad Dimensions: 1.27mm x 2.54mm (Recommended Size)

### V-I Characteristics

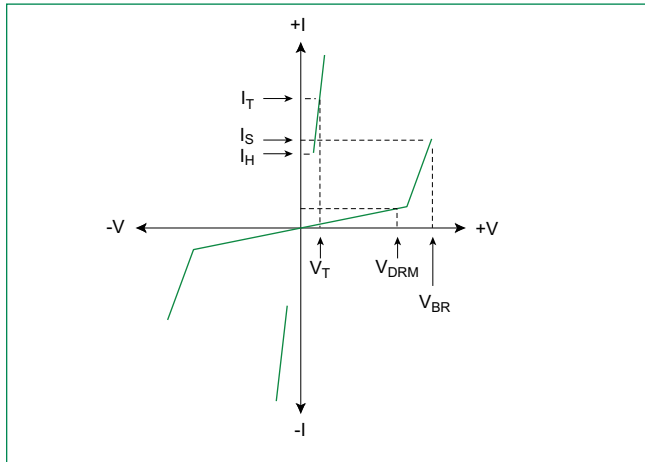

### $V_{BR}$ vs. Junction Temperature

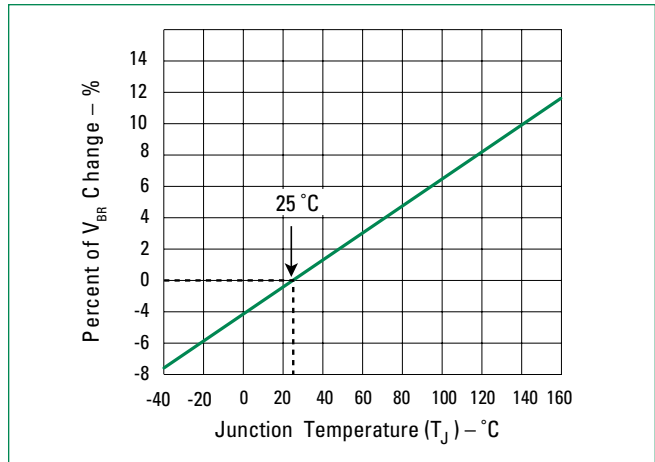

### Normalized DC Holding Current vs. Case Temperature

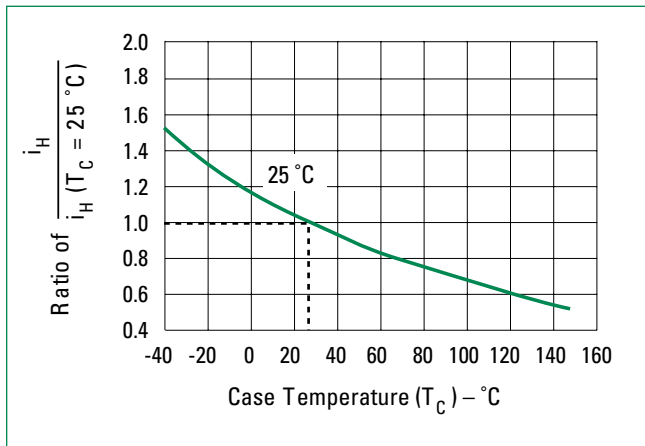

### LED Interference Test Circuit

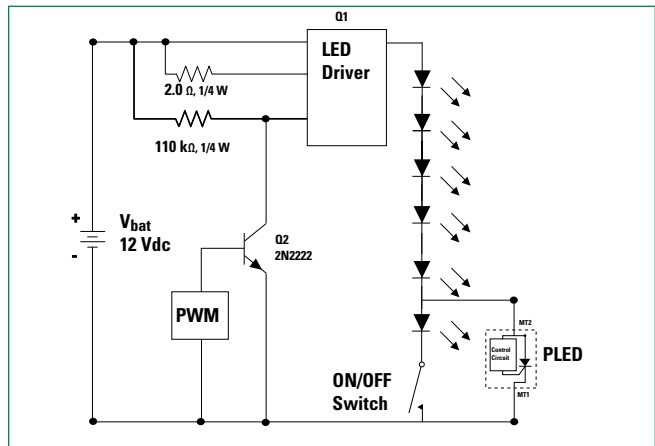

### 6 LEDs in Series 50% Duty Cycle 10kHz

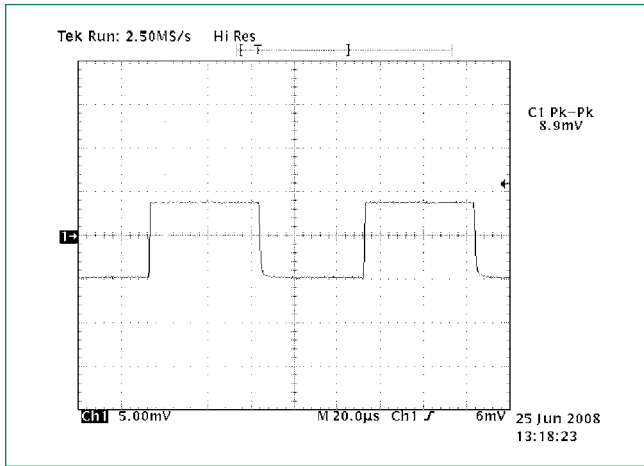

### 5 LEDs and 1 PLED in Series 50% Duty Cycle 10kHz

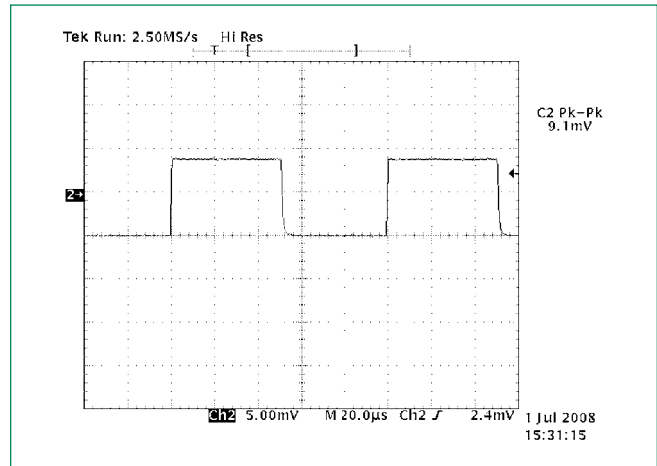

**Note:**

These two graphs show the current magnitude through the LED string with and without the PLED included. There is no noticeable effect on the LED current magnitude when the PLED is included in the circuit as compared to the LED current magnitude when the PLED is not in the circuit. (The conversion factor for the test measurement in the graphs above is 10mA/mV for the Pearson coil measurement, therefore, the current magnitude in the first figure is 10mA\*8.9 = 89mA, while the second figure is 91mA.)

### PLED in the Off-State 10kHz

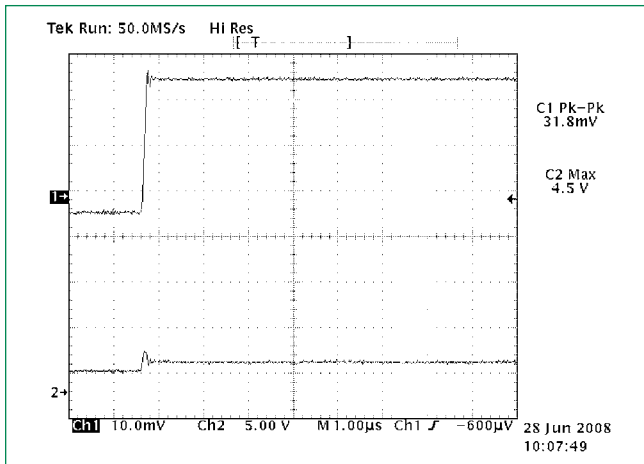

**Channel 1:** current through LEDs (318 mA)  
**Channel 2:** voltage across PLED device (4.5 V)

### PLED device zeners and then turns fully on 10kHz

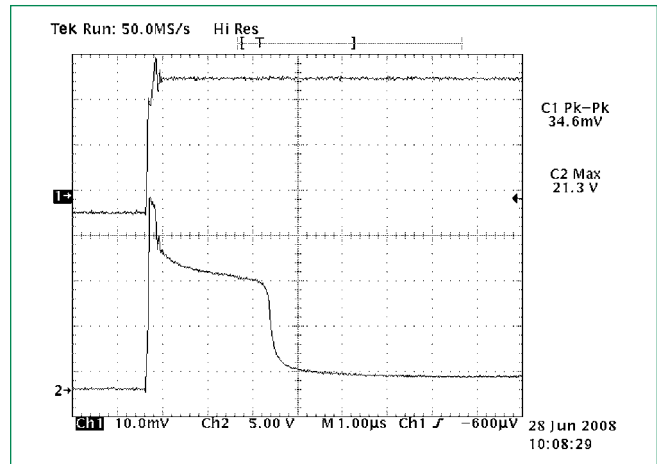

**Channel 1:** current through LEDs (346 mA) and PLED device once it is fully turned on 2.5 µsec later  
**Channel 2:** voltage across PLED device (21.3 V before PLED crowbars with 2 V drop)

### Soldering Parameters

<b>Reflow Condition</b>		Pb – Free assembly
<b>Pre Heat</b>	- Temperature Min ( $T_{s(min)}$ )	150°C
	- Temperature Max ( $T_{s(max)}$ )	200°C
	- Time (min to max) ( $t_s$ )	60 – 180 secs
<b>Average ramp up rate (Liquidus Temp (<math>T_L</math>) to peak)</b>		3°C/second max
<b><math>T_{s(max)}</math> to <math>T_L</math> - Ramp-up Rate</b>		3°C/second max
<b>Reflow</b>	- Temperature ( $T_L$ ) (Liquidus)	217°C
	- Temperature ( $t_L$ )	60 – 150 seconds
<b>Peak Temperature (<math>T_p</math>)</b>		260 <sup>+0/-5</sup> °C
<b>Time within 5°C of actual peak Temperature (<math>t_p</math>)</b>		30 seconds
<b>Ramp-down Rate</b>		6°C/second max
<b>Time 25°C to peak Temperature (<math>T_p</math>)</b>		8 minutes max
<b>Do not exceed</b>		260°C

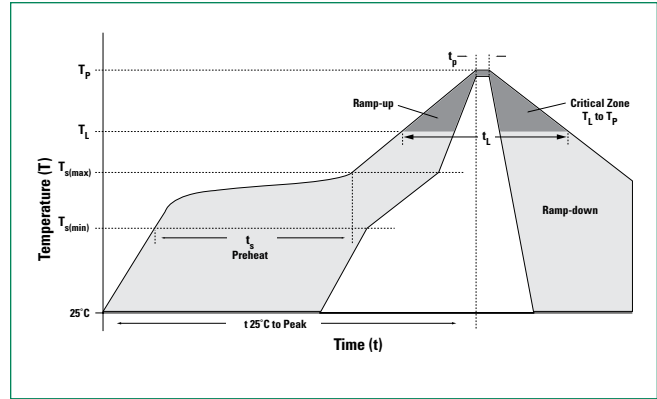

### Physical Specifications

<b>Terminal Material</b>	Copper Alloy
<b>Terminal Finish</b>	100% Matte Tin Plated
<b>Body Material</b>	UL Recognized epoxy meeting flammability classification 94V-0

### Environmental Specifications

<b>High Temperature Voltage Blocking</b>	MIL-STD-750: Method 1040, Condition A 80% min $V_{DRM}$ (VAC-peak), 150°C, 504 hours
<b>Temperature Cycling</b>	MIL-STD-750: Method 1051 -65°C to 150°C, 15-minute dwell, 100 cycles
<b>Biased Temperature &amp; Humidity</b>	EIA/JEDEC: JESD22-A101 52VDC, 85°C, 85%RH, 1008 hours
<b>High Temperature Storage</b>	MIL-STD-750: Method 1031 150°C, 1008 hours
<b>Low Temperature Storage</b>	-65°C, 1008 hours
<b>Thermal Shock</b>	MIL-STD-750: Method 1056 0°C to 100°C, 5-minute dwell, 10-second transfer, 10 cycles
<b>Resistance to Solder Heat</b>	MIL-STD-750: Method 2031 260°C, 10 seconds

**Dimensions - QFN (3x3) Package**

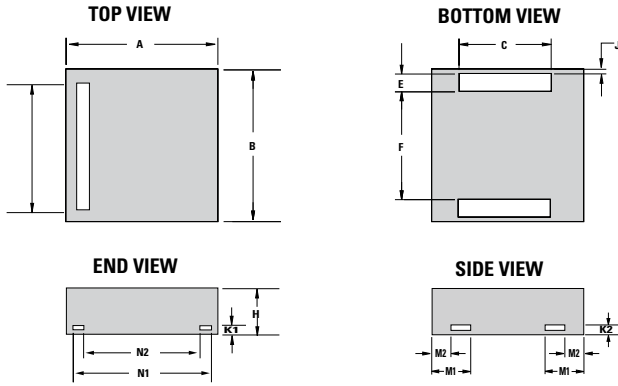

Dimensions	Inches			Millimeters		
	Min	Typ	Max	Min	Typ	Max
<b>A</b>	0.114	0.118	0.122	2.900	3.000	3.100
<b>B</b>	0.114	0.118	0.122	2.900	3.000	3.100
<b>C</b>	0.075	0.079	0.083	1.900	2.000	2.100
<b>E</b>	0.011	0.015	0.019	0.285	0.385	0.485
<b>F</b>	0.076	0.080	0.084	1.930	2.030	2.130
<b>H</b>	0.035	0.039	0.043	0.900	1.000	1.100
<b>J</b>	0.000	0.004	0.008	0.000	0.100	0.200
<b>K1</b>	0.004	0.008	0.012	0.100	0.200	0.300
<b>K2</b>	0.004	0.008	0.012	0.100	0.200	0.300
<b>M1</b>	0.056	0.060	0.064	1.143	1.530	1.630
<b>M2</b>	0.038	0.042	0.046	0.970	1.070	1.170
<b>N1</b>	0.096	0.100	0.104	2.440	2.540	2.640
<b>N2</b>	0.082	0.086	0.090	2.080	2.180	2.280

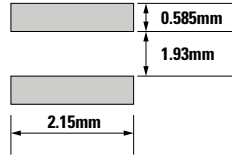

Recommended solder pad layout  
(Reference Only)

**Dimensions - DO-214 AA Package**

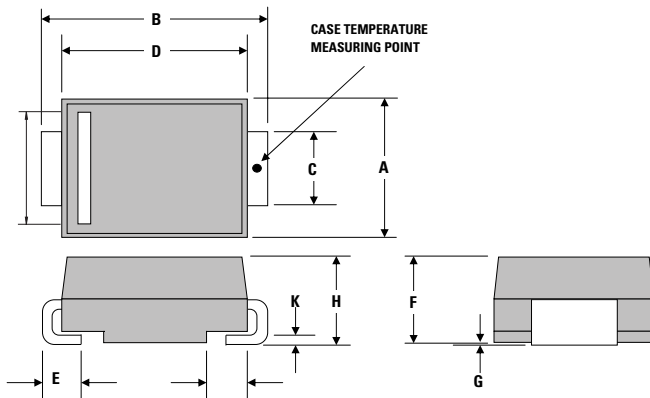

Dimensions	Inches		Millimeters	
	Min	Max	Min	Max
<b>A</b>	0.130	0.156	3.30	3.95
<b>B</b>	0.201	0.220	5.10	5.60
<b>C</b>	0.077	0.087	1.95	2.20
<b>D</b>	0.159	0.181	4.05	4.60
<b>E</b>	0.030	0.063	0.75	1.60
<b>F</b>	0.075	0.096	1.90	2.45
<b>G</b>	0.002	0.008	0.05	0.20
<b>H</b>	0.077	0.104	1.95	2.65
<b>K</b>	0.006	0.016	0.15	0.41

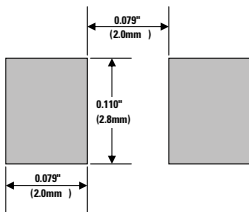

Recommended solder pad layout  
(Reference Only)

### Part Numbering System

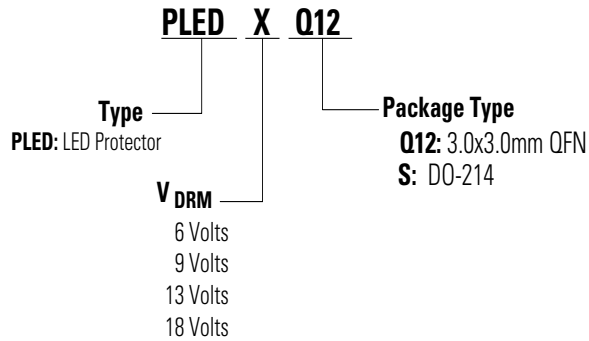

### Part Marking System

#### DO-214

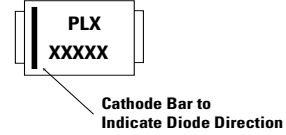

#### QFN

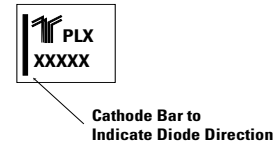

### Packaging

Package	Description	Packaging Quantity	Industry Standard
Q12	QFN 3x3	5000	EIA-481-1
S	DO-214	2500	EIA-481-1

### Tape and Reel Specification - QFN (3x3)

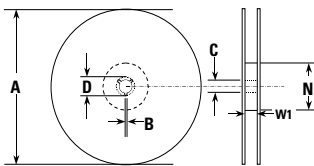

Reel Dimension

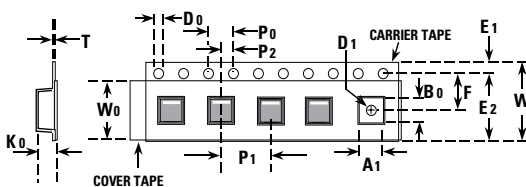

Tape Dimension Items

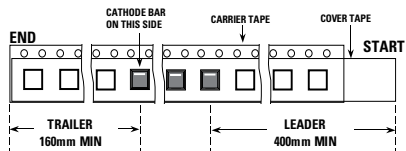

Leader and Trailer Dimension of the Ttape

Symbols	Description	Inches		Millimeters	
		Min	Max	Min	Max
<b>A</b>	Reel Diameter	N/A	12.992	N/A	330.0
<b>B</b>	Drive Spoke Width	0.059	N/A	1.50	N/A
<b>C</b>	Arbor Hole Diameter	0.504	0.531	12.80	13.50
<b>D</b>	Drive Spoke Diameter	0.795	N/A	20.20	N/A
<b>N</b>	Hub Diameter	1.969	N/A	50.00	N/A
<b>W1</b>	Reel Inner Width at Hub	0.488	0.567	12.40	14.40
<b>A0</b>	Pocket Width at bottom	0.126	0.134	3.20	3.40
<b>B0</b>	Pocket Length at bottom	0.126	0.134	3.20	3.40
<b>D0</b>	Feed Hole Diameter	0.059	0.063	1.50	1.60
<b>D1</b>	Pocket Hole Diameter	0.059	N/A	1.50	N/A
<b>E1</b>	Feed hole Position 1	0.065	0.073	1.65	1.85
<b>E2</b>	Feed hole Position 2	0.400	0.408	10.15	10.35
<b>F</b>	Feed hole center-Pocket hole	0.215	0.219	5.45	5.55
<b>K0</b>	Pocket Depth	0.039	0.051	1.00	1.30
<b>P0</b>	Feed hole Pitch	0.153	0.161	3.90	4.10
<b>P1</b>	Component Spacing	0.311	0.319	7.90	8.10
<b>P2</b>	Feed hole center-Pocket hole	0.077	0.081	1.90	2.06
<b>T</b>	Carrier Tape Thickness	0.010	0.014	0.25	0.35
<b>W</b>	Embossed Carrier Tape Width	0.453	0.484	11.50	12.30
<b>W0</b>	Cover Tape Width	0.358	0.366	9.10	9.30

**DO-214 Embossed Carrier Reel Pack (RP)**

Meets all EIA-481-1 Standards

