

PL Series

5 Tumbler Miniature Switchlocks



Description

When office furniture, cash register or copy machine designers need a long-lasting, high-quality switch to secure their products, they turn to the PL series 5 tumbler miniature camlock. The PL series are known for being a cost-effective security solution and have several custom cams available.

Features & Benefits

- Cost-effective security
- Custom cams available

Applications

- Office furniture
- Cash registers
- Copy machines

Agency Approval

Agency	Agency File Number
	E42363

Electrical Characteristics

Indexing	90°: 2 Positions.
Switch	4 A @ 125 V AC; 2 A @ 250 V AC (UL)
Maximum Temperature	65 deg. cel.

Notes:
Specifications and materials listed above are for cam locks with standard options. For information on specific and custom cam locks, consult Customer Service Center.

Materials

Lock	6/6 nylon (UL 94V-2). Color, black. 5 tumbler, single bitted lock with integral detent mechanism.
Keys	Two nickel plated brass keys with black plastic insert molded head.
Cams	6/6 nylon (UL 94V-2).

Ordering Number

To order, simply select desired option from each category and place in the appropriate box. For additional options not shown in catalog, consult Customer Service Center.

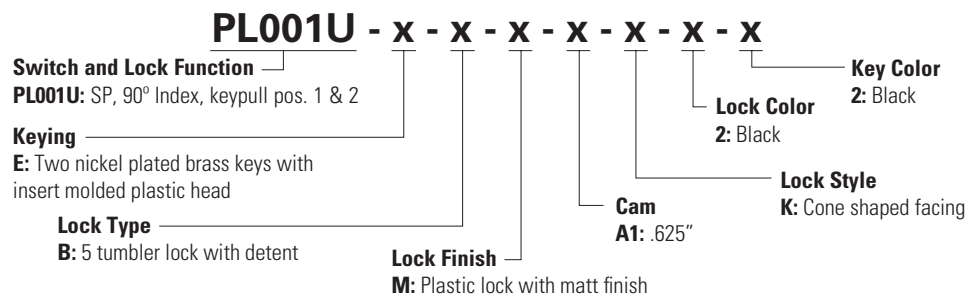

PL Series

5 Tumbler Miniature Switchlocks



Switch and Lock Function

Model No.	Key Pull Positions	Lock Configuration	Indexing
PL001U	Positions 1 & 2		90°

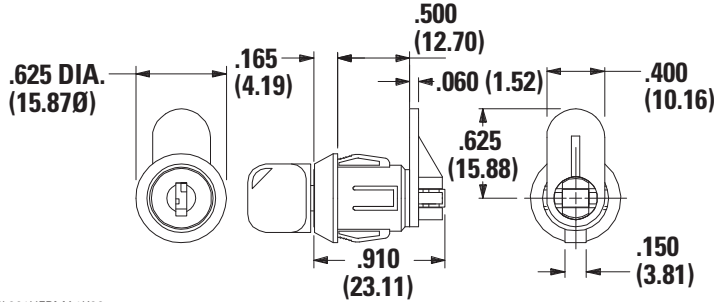

LEGEND

- = Detent Position (90°)
- ⊙ = Key pull possible in these positions.
- ⊙ = Stop Positions

Key Part Number: PL001UEBMA1K22

Keying & Key Color

E Two Nickel Plated Brass keys with insert molded plastic head

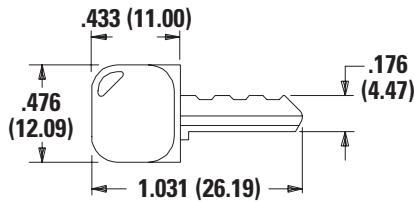

Key Part Number: 617D1004102

Lock Type & Lock Color

B 5 Tumbler with Detent

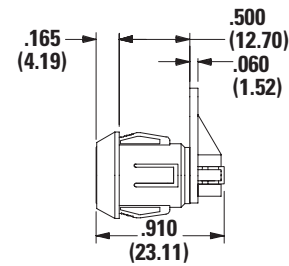

Option Code	Key Color
2	Black

Option Code	Lock Color
2	Black

Note:
All orders keyed alike, standard. For more than one key code, replacement keys, or other special features, consult Customer Service Center.

Lock Finish

M Plastic Lock with Matte Finish



Cam

A1 0.625"

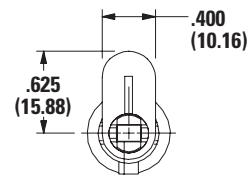

Notes:

Cam not assembled to switch. Other cam lengths and styles available, consult Customer Service Center.

PL Series

5 Tumbler Miniature Switchlocks



Lock Style K Cone Shaped Facing

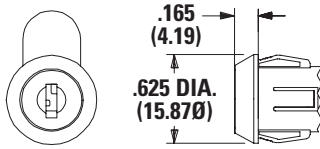

Panel Mounting

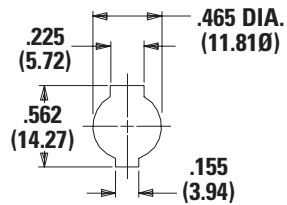

Note:

Panel Thickness: 0.050-0.080 (1.27-2.03)

Available Hardware



Key Code: 041
 Part No. (One Key)
 617D1004102 Black
Material: Brass
Finish: Nickel Plate
 6/6 Nylon insert molded head