

GT Series

Sealed Ultraminiature Toggle Switches

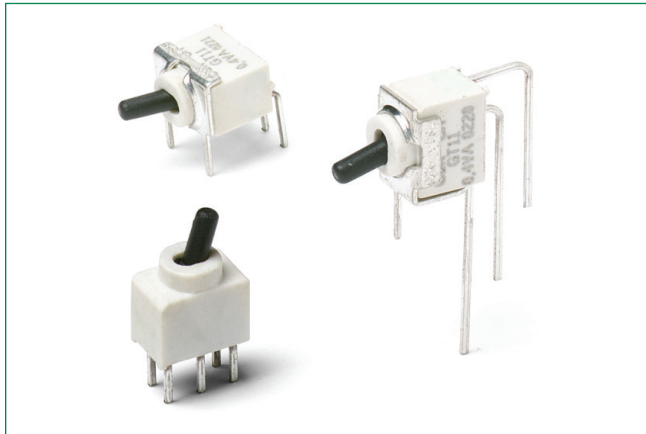

Description

GT series sealed ultraminiature toggle switches are used most often in hand-held telecommunications devices or those applications that require small instrumentation. The GT series are ultraminiature switches – featuring the smallest footprint available in the industry. GT switches are built using high-temperature materials (UL 94V-0) and are sealed against solder and cleaning process contaminants – ensuring they will last when used in harsh environments.

Features & Benefits

- Sealed against solder and cleaning process contaminants
- Ultraminiature size, smallest footprint available
- Thru-hole and surface mount models
- High temperature materials (UL 94V-0)
- RoHS compliant and compatible

Applications

- Hand-held telecommunications
- Small instrumentation

Specifications

Contact Rating	0.4 VA max. @ 20 V AC or DC max.
Mechanical & Electrical Life	40,000 make-and-break cycles at full load.
Contact Resistance	Below 50 m Ω typ. initial @ 2-4 V DC, 100 mA.
Insulation Resistance	10 ⁹ Ω min.
Dielectric Strength	500 Vrms min. @ sea level.
Operating Temperature	-30°C to 85°C
Solderability	Per MIL-STD-202F method 208D, or EIA RS-186E method 9 (1 hour steam aging).
Packaging	Surface mount switches shipped in anti-static tape and reel packaging per EIA 481-3. Tape and cover strip are conductive for use near statically sensitive components, consult Customer Service Center.

Materials

Housing & Base	Glass filled nylon 4/6, flame retardant, heat stabilized (UL 94V-0).
Actuator	Glass filled nylon 4/6, flame retardant, heat stabilized (UL 94V-0), with standard internal o-ring seal.
Switch Support	Brass, tin plated.
Movable Contacts	Copper alloy, with gold plate over nickel plate.
Stationary Contacts	Copper alloy, with gold plate over nickel plate.
Terminals	Gold
Terminal Seal	Epoxy. All terminals insert molded.

Notes:

Specifications and materials listed above are for switches with standard options. For information on specific and custom switches, consult Customer Service Center.

Ordering Number

Our easy build-a-switch concept allows you to mix and match options to create the switch you need. To order, select desired option from each category and place it in the appropriate box.

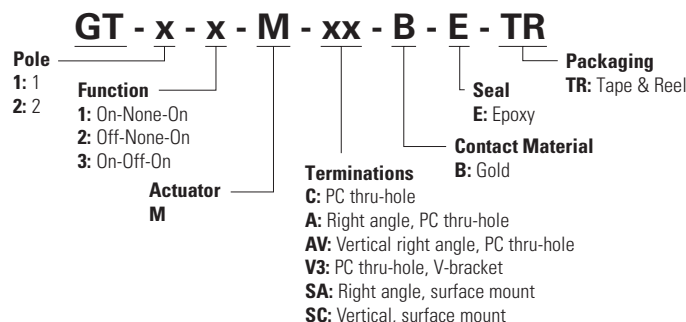

GT Series

Sealed Ultraminiature Toggle Switches



Switch Function

Part Number	POS. 1	POS. 2	POS. 3
GT11MCBE	ON	NONE	ON
GT13MCBE	ON	OFF	ON
Conn. Terms	2-3	OPEN	2-1

Schematic

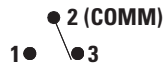

SPDT

Note: Pins 4 and 6 not connected

GT12MCBE	OFF	NONE	ON
Conn. Terms.	OPEN	N/A	3-1

Schematic



SPST

Note: Pins 4 and 6 not connected

Switch Function

Part Number	POS. 1	POS. 2	POS. 3
GT21MCBE	ON	NONE	ON
GT23MCBE	ON	OFF	ON
Conn. Terms	2-3, 5-6	OPEN	2-1, 5-4

Schematic



DPDT

GT22MCBE	OFF	NONE	ON
Conn. Terms.	OPEN	N/A	3-1, 6-4

Schematic

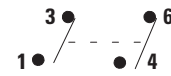

DPST

GT11MCBE SPDT

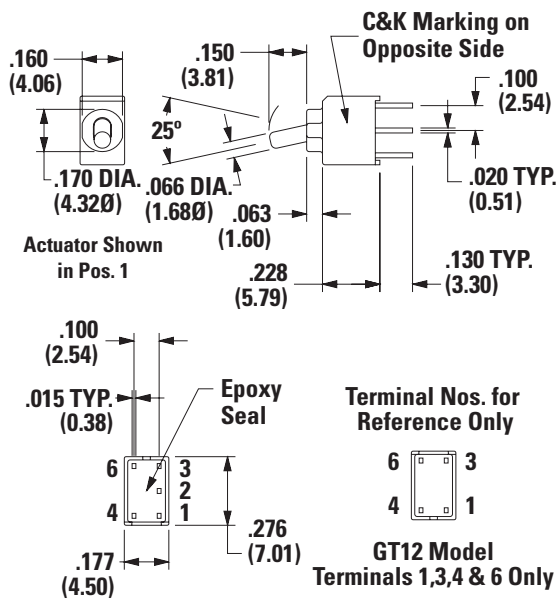

GT21MCBE DPDT

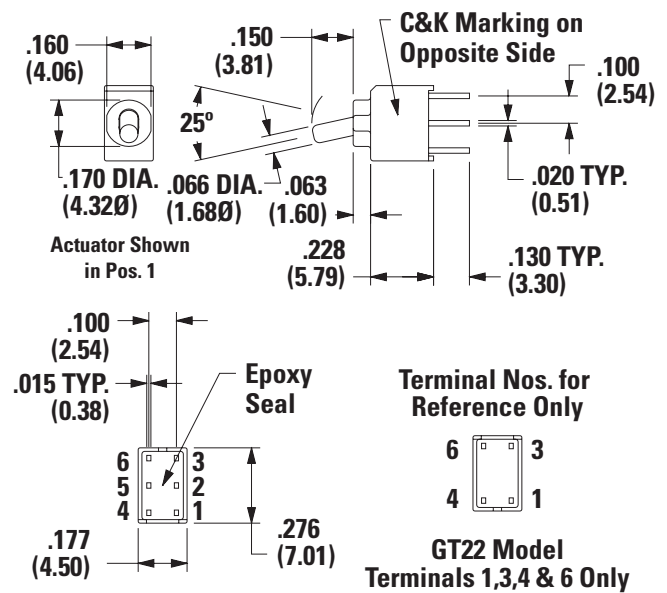

PC Mounting

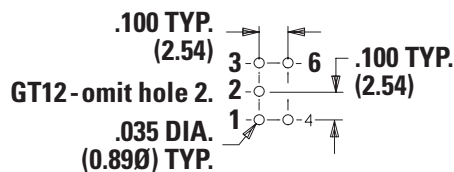

PC Mounting

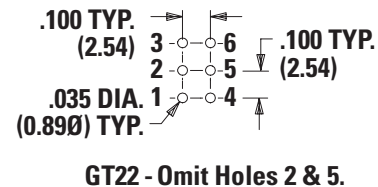

GT Series

Sealed Ultraminiature Toggle Switches



Switch Function

Part Number	POS. 1	POS. 2	POS. 3
GT11MABE	ON	NONE	ON
GT13MABE		OFF	
Conn. Terms	2-3	OPEN	2-1

Schematic



SPDT

GT12MABE	OFF	NONE	ON
Conn. Terms.	OPEN	N/A	3-1

Schematic



SPST

GT11MABE Horizontal Actuation SPDT

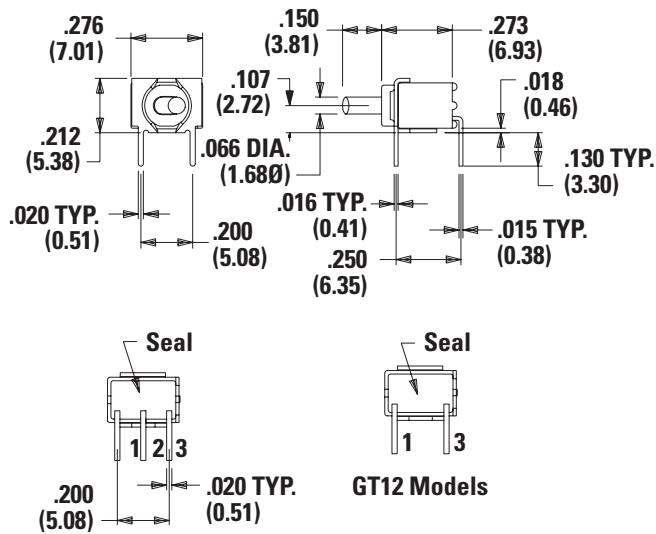

Switch Function

Part Number	POS. 1	POS. 2	POS. 3
GT21MABE	ON	NONE	ON
GT23MABE		OFF	
Conn. Terms	2-3, 5-6	OPEN	2-1, 5-4

Schematic



DPDT

GT22MABE	OFF	NONE	ON
Conn. Terms.	OPEN	N/A	3-1, 6-4

Schematic

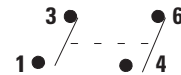

DPST

GT21MABE Horizontal Actuation DPDT

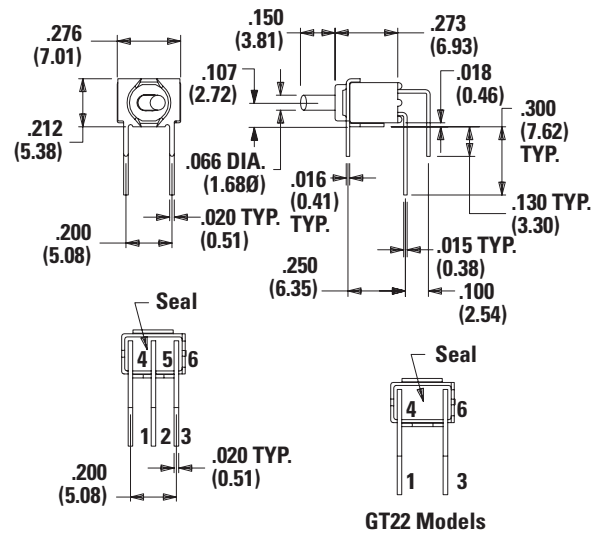

PC Mounting

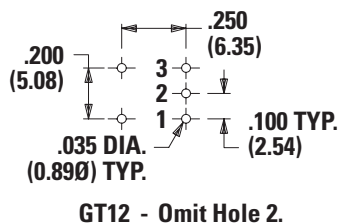

PC Mounting

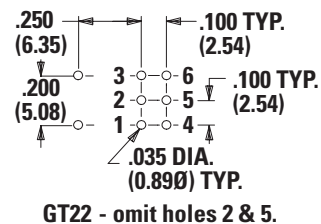

GT Series

Sealed Ultraminiature Toggle Switches



Switch Function

Part Number	POS. 1	POS. 2	POS. 3
GT11MAVBE	ON	NONE	ON
GT13MAVBE		OFF	
Conn. Terms	2-3	OPEN	2-1

Schematic



SPDT

Note: Pins 4 and 6 not connected

GT12MAVBE	OFF	NONE	ON
Conn. Terms.	OPEN	N/A	3-1

Schematic



SPST

Note: Pins 4 and 6 not connected

GT11MAVBE Vertical Actuation SPDT

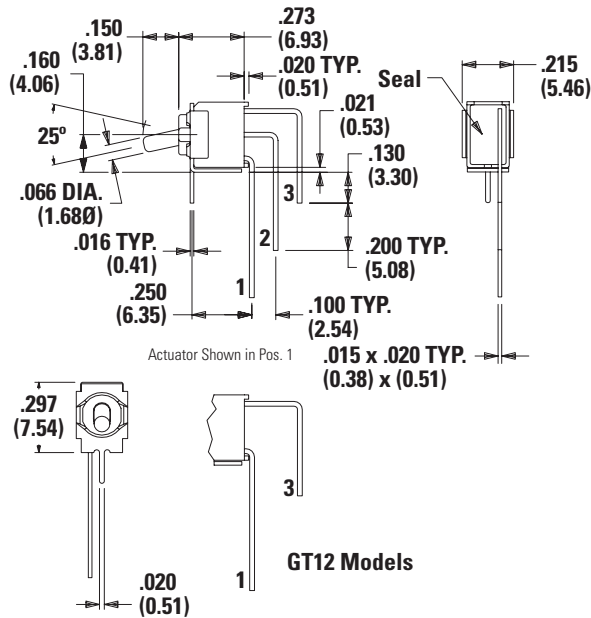

Switch Function

Part Number	POS. 1	POS. 2	POS. 3
GT21MAVBE	ON	NONE	ON
GT23MAVBE		OFF	
Conn. Terms	2-3, 5-6	OPEN	2-1, 5-4

Schematic



DPDT

GT22MAVBE	OFF	NONE	ON
Conn. Terms.	OPEN	N/A	3-1, 6-4

Schematic

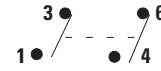

DPST

GT21MAVBE Vertical Actuation DPDT

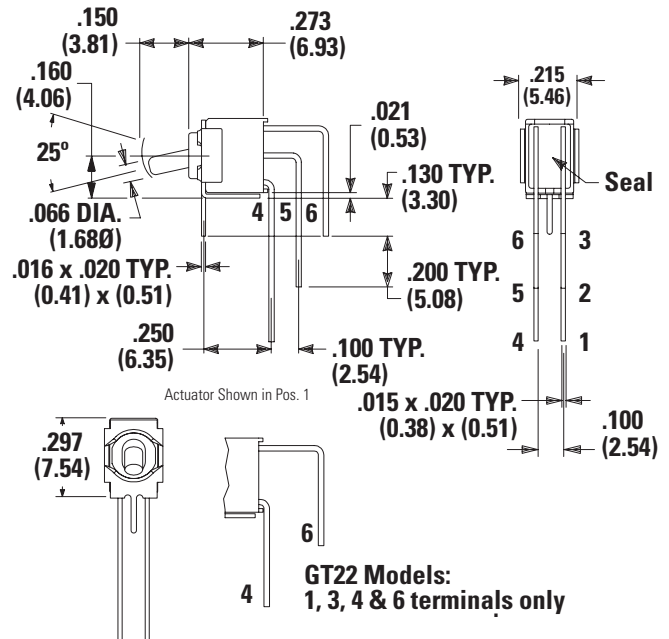

PC Mounting

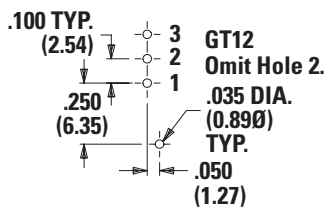

PC Mounting

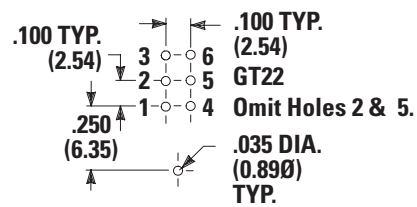

GT Series

Sealed Ultraminiature Toggle Switches



Switch Function

Part Number	POS. 1	POS. 2	POS. 3
GT11MV3BE	ON	NONE	ON
GT13MVBE	ON	OFF	ON
Conn. Terms	2-3	OPEN	2-1

Schematic



SPDT

Note: Pins 4 and 6 not connected

GT12MV3BE	OFF	NONE	ON
Conn. Terms.	OPEN	N/A	3-1

Schematic



SPST

Note: Pins 4 and 6 not connected

GT11MV3BE SPDT

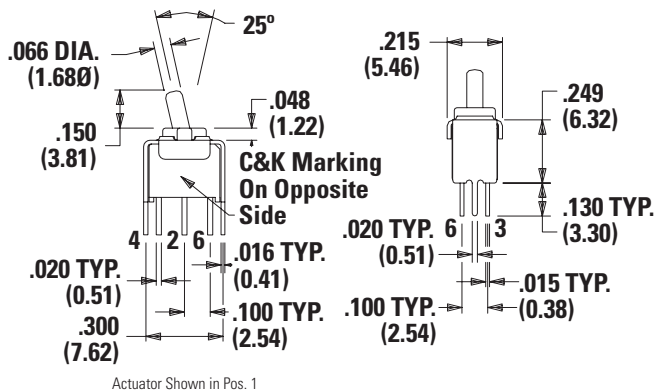

GT12 Models

PC Mounting

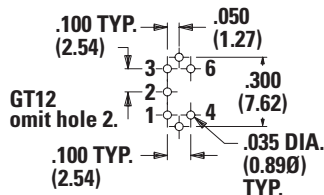

Switch Function

Part Number	POS. 1	POS. 2	POS. 3
GT21MV3BE	ON	NONE	ON
GT23MV3BE	ON	OFF	ON
Conn. Terms	2-3, 5-6	OPEN	2-1, 5-4

Schematic



DPDT

GT22MV3BE	OFF	NONE	ON
Conn. Terms.	OPEN	N/A	3-1, 6-4

Schematic

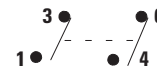

DPST

GT21MV3BE DPDT

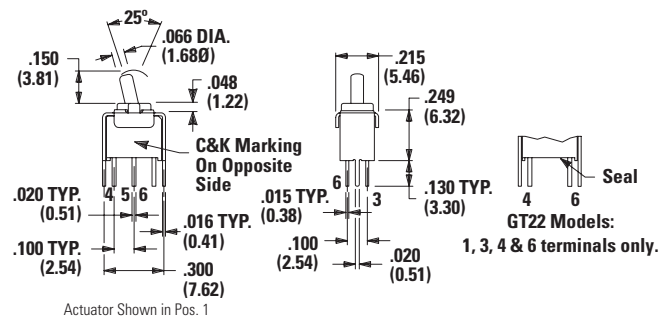

PC Mounting

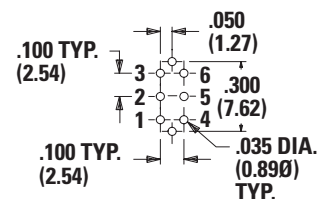

GT Series

Sealed Ultraminiature Toggle Switches



Switch Function

Part Number	POS. 1	POS. 2	POS. 3
GT11MSABETR	ON	NONE	ON
GT13MSABETR		OFF	
Conn. Terms	2-3	OPEN	2-1

Schematic



SPDT

Part Number	POS. 1	POS. 2	POS. 3
GT12MSABETR	OFF	NONE	ON
Conn. Terms.	OPEN	N/A	3-1

Schematic



SPST

Switch Function

Part Number	POS. 1	POS. 2	POS. 3
GT11MSCBETR	ON	NONE	ON
GT13MSCBETR		OFF	
Conn. Terms	2-3	OPEN	2-1

Schematic



SPDT

Note: Pins 4 and 6 not connected

Part Number	POS. 1	POS. 2	POS. 3
GT12MSCBETR	OFF	NONE	ON
Conn. Terms.	OPEN	N/A	3-1

Schematic



SPST

Note: Pins 4 and 6 not connected

GT11MSABE Horizontal Actuation SPDT

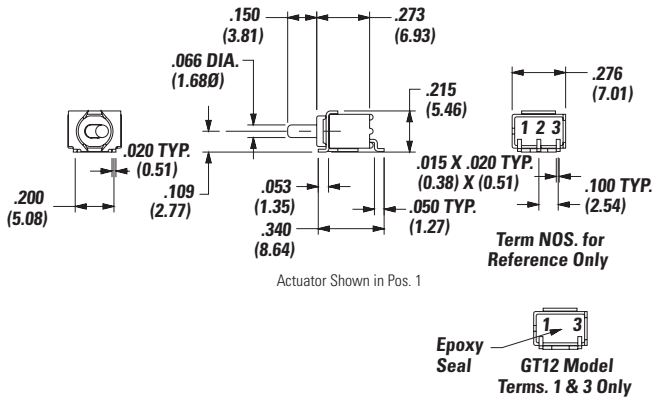

Standard with tape & reel packaging, see page 7.

GT11MSCBE SPDT

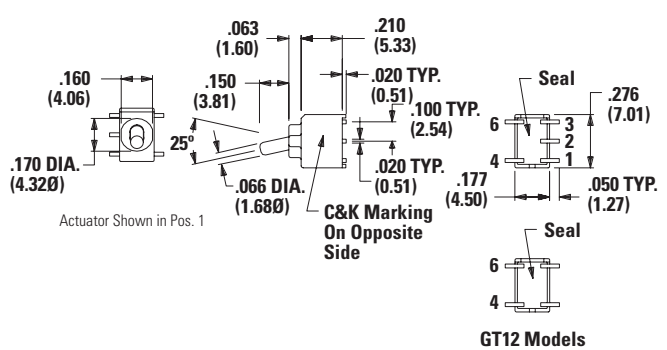

Standard with tape & reel packaging, see page 8.

PC Mounting

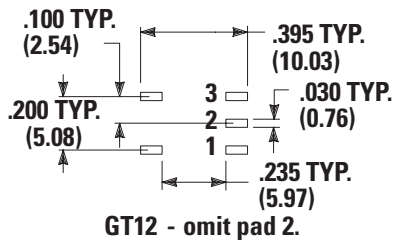

PC Mounting

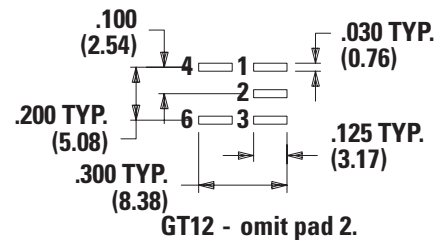

GT Series

Sealed Ultraminiature Toggle Switches



Switch Function

Part Number	POS. 1	POS. 2	POS. 3
GT21MSCBETR	ON	NONE	ON
GT23MSCBETR		OFF	ON
Conn. Terms	2-3, 5-6	OPEN	2-1, 5-4

Schematic



DPDT

Part Number	POS. 1	POS. 2	POS. 3
GT22MSCBETR	OFF	NONE	ON
Conn. Terms	OPEN	N/A	3-1, 6-4

Schematic



DPST

GT21MSCBE DPDT

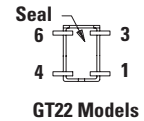
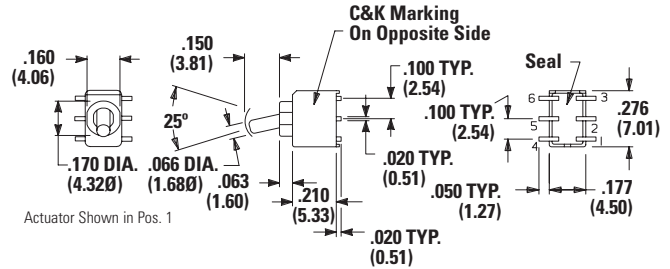

PC Mounting

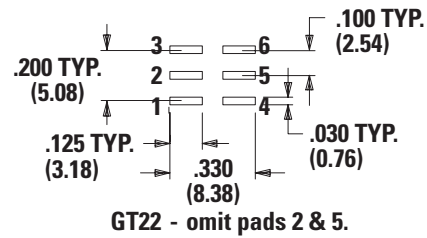

Standard with tape & reel packaging.

Tape & Reel

For part numbers GT11MSABE, GT12MSABE, GT13MSABE

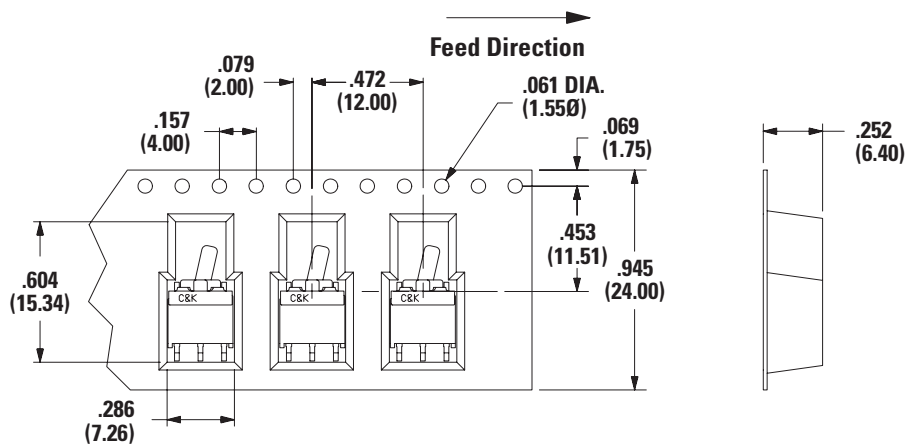

Reel Information

Outside Diameter	13.00 (330.0)
Pilot Hole	0.512 (13.0)
Quantity per Reel	600

GT Series

Sealed Ultraminiature Toggle Switches



For part numbers GT11MSCBE, GT12MSCBE, GT13MSCBE, GT21MSCBE, GT22MSCBE, GT23MSCBE.

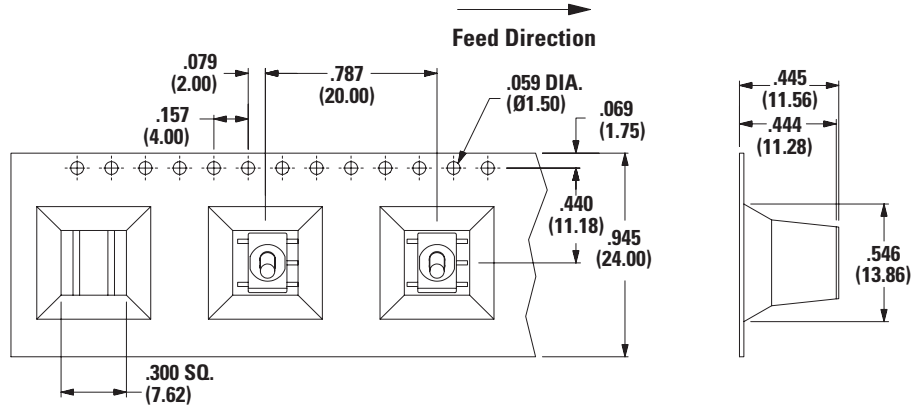

Reel Information

Outside Diameter	13.00 (330.0)
Pilot Hole	0.512 (13.0)
Quantity per Reel	200

Disclaimer Notice - Information furnished is believed to be accurate and reliable. However, users should independently evaluate the suitability of and test each product selected for their own applications. Littelfuse products are not designed for, and may not be used in, all applications. Read complete Disclaimer Notice at <http://www.littelfuse.com/disclaimer-electronics>.