

## GenX3™ 600V IGBT

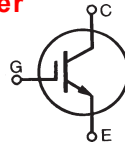
### IXGA48N60B3

### IXGP48N60B3\*

### IXGH48N60B3

\*Obsolete Part Number

Medium speed low V<sub>sat</sub> PT IGBTs 5-40 kHz switching



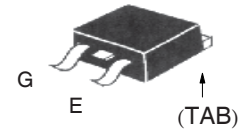
V<sub>CES</sub> = 600V

I<sub>C110</sub> = 48A

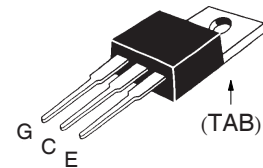
V<sub>CE(sat)</sub> ≤ 1.8V

Symbol	Test Conditions	Maximum Ratings	
V <sub>CES</sub>	T <sub>C</sub> = 25°C to 150°C	600	V
V <sub>CGR</sub>	T <sub>J</sub> = 25°C to 150°C, R <sub>GE</sub> = 1MΩ	600	V
V <sub>GES</sub>	Continuous	± 20	V
V <sub>GEM</sub>	Transient	± 30	V
I <sub>C110</sub>	T <sub>C</sub> = 110°C	48	A
I <sub>CM</sub>	T <sub>C</sub> = 25°C, 1ms	280	A
SSOA (RBSOA)	V <sub>GE</sub> = 15V, T <sub>VJ</sub> = 125°C, R <sub>G</sub> = 5Ω Clamped inductive load @ ≤ 600V	I <sub>CM</sub> = 120	A
P <sub>C</sub>	T <sub>C</sub> = 25°C	300	W
T <sub>J</sub>		-55 ... +150	°C
T <sub>JM</sub>		150	°C
T <sub>stg</sub>		-55 ... +150	°C
T <sub>L</sub>	1.6mm (0.062 in.) from case for 10s	300	°C
T <sub>SOLD</sub>	Plastic body for 10 seconds	260	°C
M <sub>d</sub>	Mounting torque (TO-247)(TO-220)	1.13/10	Nm/lb.in.
Weight	TO-263	2.5	g
	TO-220	3.0	g
	TO-247	6.0	g

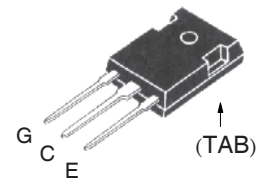
TO-263 (IXGA)



TO-220 (IXGP)



TO-247 (IXGH)



G = Gate      C = Collector  
E = Emitter    TAB = Collector

### Features

- Optimized for low conduction and switching losses
- Square RBSOA
- International standard packages

### Advantages

- High power density
- Low gate drive requirement

### Applications

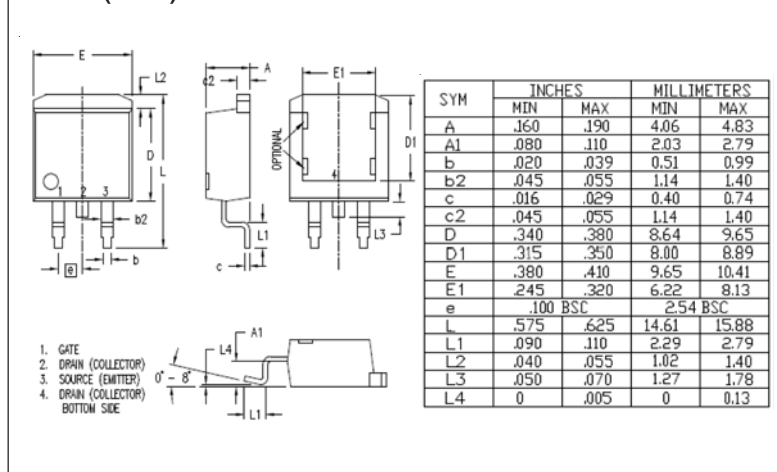
- Power Inverters
- UPS
- Motor Drives
- SMPS
- PFC Circuits
- Battery Chargers
- Welding Machines
- Lamp Ballasts

Symbol	Test Conditions (T <sub>J</sub> = 25°C unless otherwise specified)	Characteristic Values		
		Min.	Typ.	Max.
BV <sub>CES</sub>	I <sub>C</sub> = 250μA, V <sub>GE</sub> = 0V	600		V
V <sub>GE(th)</sub>	I <sub>C</sub> = 250μA, V <sub>CE</sub> = V <sub>GE</sub>	3.0		5.0 V
I <sub>CES</sub>	V <sub>CE</sub> = V <sub>CES</sub>			25 μA
	V <sub>GE</sub> = 0V      T <sub>J</sub> = 125°C			250 μA
I <sub>GES</sub>	V <sub>CE</sub> = 0V, V <sub>GE</sub> = ± 20V			±100 nA
V <sub>CE(sat)</sub>	I <sub>C</sub> = 32A, V <sub>GE</sub> = 15V, Note 1			1.8 V

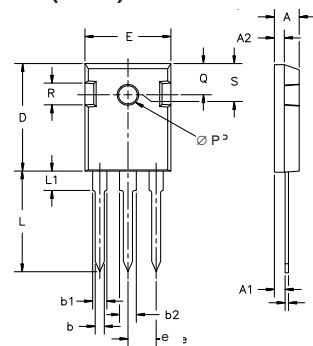
Symbol	Test Conditions	Characteristic Values		
		Min.	Typ.	Max.
$T_J = 25^\circ\text{C}$ unless otherwise specified)				
$g_{fs}$	$I_C = 30\text{A}, V_{CE} = 10\text{V}$ , Note 1	28	46	S
$C_{ies}$	$V_{CE} = 25\text{V}, V_{GE} = 0\text{V}, f = 1\text{MHz}$		3980	pF
$C_{oes}$			170	pF
$C_{res}$			45	pF
$Q_g$	$I_C = 40\text{A}, V_{GE} = 15\text{V}, V_{CE} = 0.5 \cdot V_{CES}$		115	nC
$Q_{ge}$			21	nC
$Q_{gc}$			40	nC
$t_{d(on)}$	<b>Inductive Load, <math>T_J = 25^\circ\text{C}</math></b> $I_C = 30\text{A}, V_{GE} = 15\text{V}$ $V_{CE} = 480\text{V}, R_G = 5\Omega$		22	ns
$t_{ri}$			25	ns
$E_{on}$			0.84	mJ
$t_{d(off)}$			130	200 ns
$t_{fi}$			116	200 ns
$E_{off}$			0.66	1.20 mJ
$t_{d(on)}$	<b>Inductive Load, <math>T_J = 125^\circ\text{C}</math></b> $I_C = 30\text{A}, V_{GE} = 15\text{V}$ $V_{CE} = 480\text{V}, R_G = 5\Omega$		19	ns
$t_{ri}$			25	ns
$E_{on}$			1.71	mJ
$t_{d(off)}$			190	ns
$t_{fi}$			157	ns
$E_{off}$			1.30	mJ
$R_{thJC}$			0.42	$^\circ\text{C/W}$
$R_{thCS}$	(TO-247)	0.25		$^\circ\text{C/W}$
	(TO-220)	0.50		$^\circ\text{C/W}$

Note 1: Pulse test,  $t \leq 300\mu\text{s}$ ; duty cycle,  $d \leq 2\%$ .

### TO-263 (IXGA) Outline

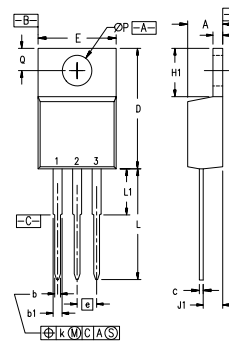


### TO-247 (IXGH) Outline



Dim.	Millimeter		Inches	
	Min.	Max.	Min.	Max.
A	4.7	5.3	.185	.209
A <sub>1</sub>	2.2	2.54	.087	.102
A <sub>2</sub>	2.2	2.6	.059	.098
b	1.0	1.4	.040	.055
b <sub>1</sub>	1.65	2.13	.065	.084
b <sub>2</sub>	2.87	3.12	.113	.123
C	.4	.8	.016	.031
D	20.80	21.46	.819	.845
E	15.75	16.26	.610	.640
e	5.20	5.72	0.205	0.225
L	19.81	20.32	.780	.800
L1		4.50		.177
∅P	3.55	3.65	.140	.144
Q	5.89	6.40	0.232	0.252
R	4.32	5.49	.170	.216
S	6.15	BSC	.242	BSC

### TO-220 (IXGP) Outline



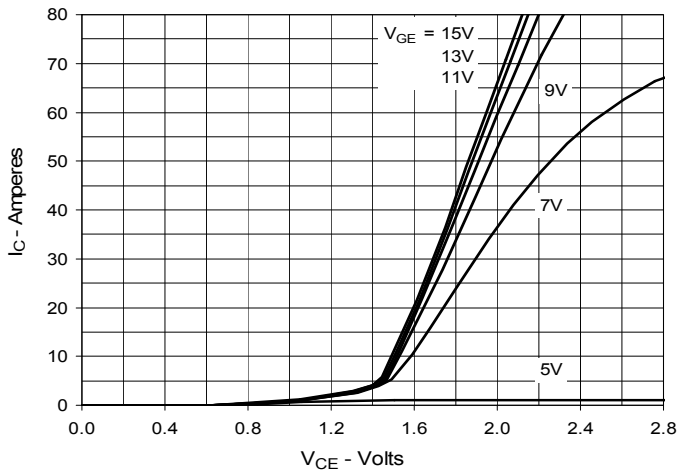
Pins: 1 - Gate 2 - Drain  
3 - Source 4 - Drain

SYM	INCHES		MILLIMETERS	
	MIN	MAX	MIN	MAX
A	.170	.190	4.32	4.83
b	.025	.040	0.64	1.02
b1	.045	.065	1.15	1.65
c	.014	.022	0.35	0.56
D	.580	.630	14.73	16.00
E	.390	.420	9.91	10.66
e	.100 BSC		2.54 BSC	
F	.045	.055	1.14	1.40
H1	.230	.270	5.85	6.85
J1	.090	.110	2.29	2.79
k	0	.015	0	0.38
L	.500	.550	12.70	13.97
L1	.110	.230	2.79	5.84
∅P	.139	.161	3.53	4.08
Q	.100	.125	2.54	3.18

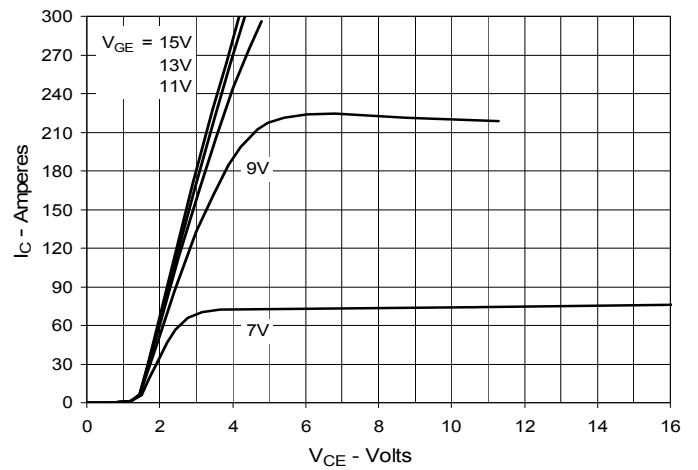
IXYS reserves the right to change limits, test conditions and dimensions.

IXYS MOSFETs and IGBTs are covered 4,835,592 4,931,844 5,049,961 5,237,481 6,162,665 6,404,065 B1 6,683,344 6,727,585 7,005,734 B2 7,157,338B2  
by one or more of the following U.S. patents: 4,850,072 5,017,508 5,063,307 5,381,025 6,259,123 B1 6,534,343 6,759,692 7,063,975 B2  
4,881,106 5,034,796 5,187,117 5,486,715 6,306,728 B1 6,583,505 6,710,463 6,771,478 B2 7,071,537

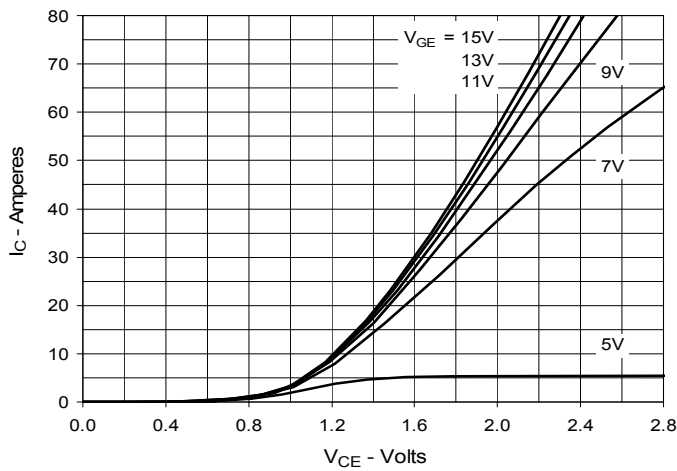
**Fig. 1. Output Characteristics @ 25°C**



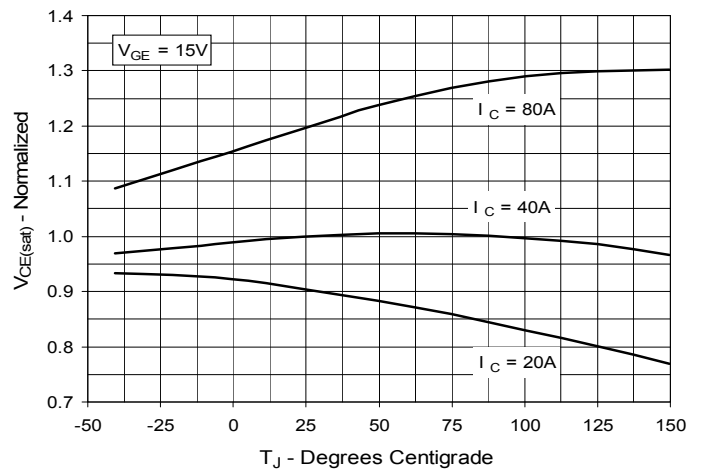
**Fig. 2. Extended Output Characteristics @ 25°C**



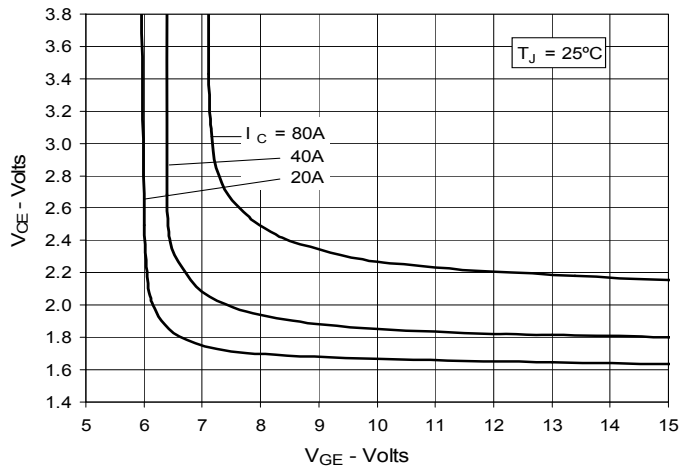
**Fig. 3. Output Characteristics @ 125°C**



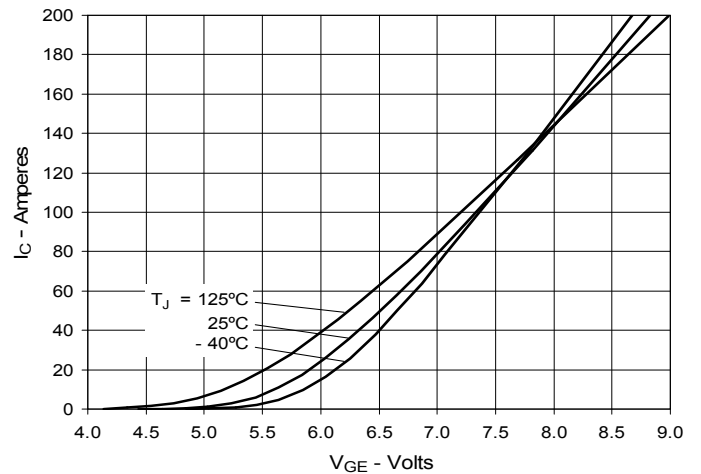
**Fig. 4. Dependence of Vce(sat) on Junction Temperature**



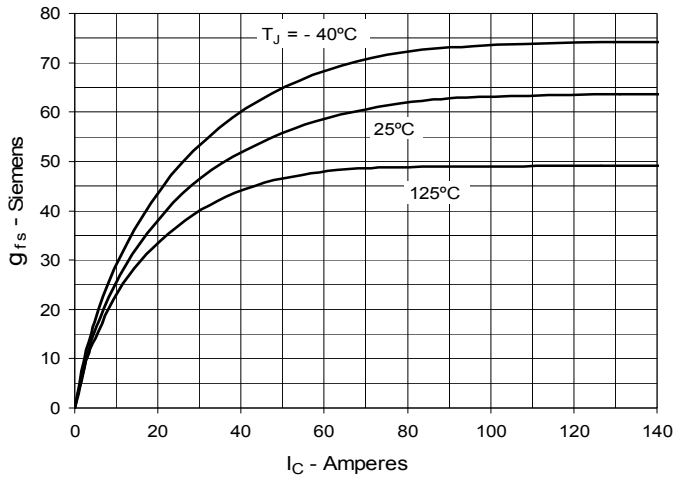
**Fig. 5. Collector-to-Emitter Voltage vs. Gate-to-Emitter Voltage**



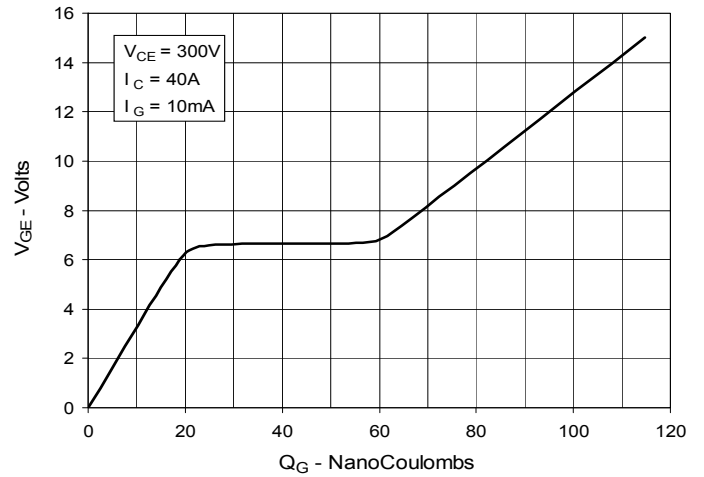
**Fig. 6. Input Admittance**



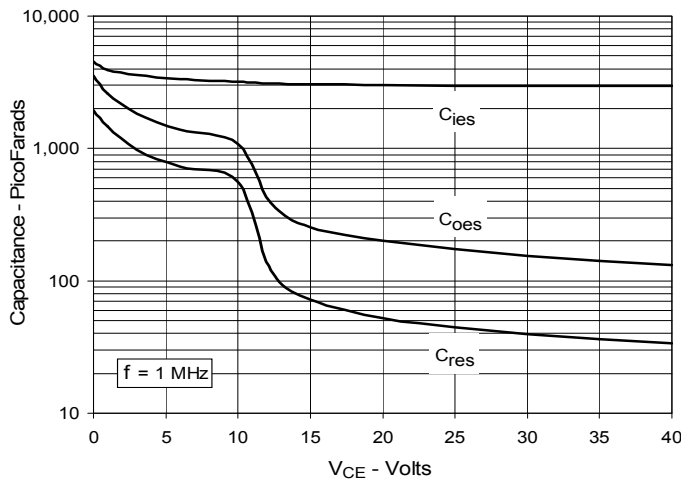
**Fig. 7. Transconductance**



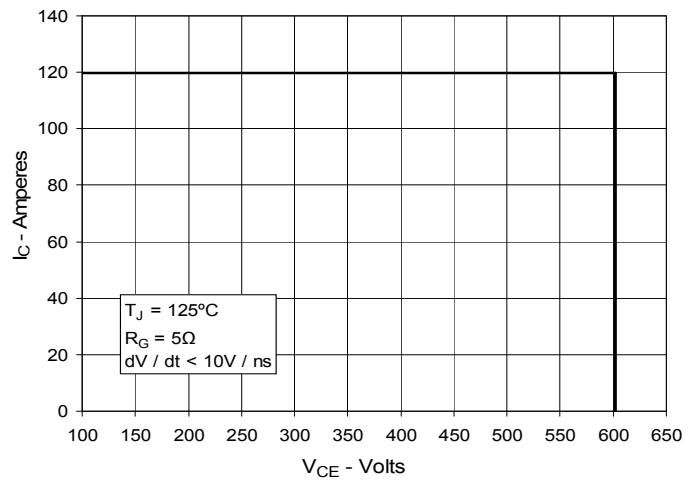
**Fig. 8. Gate Charge**



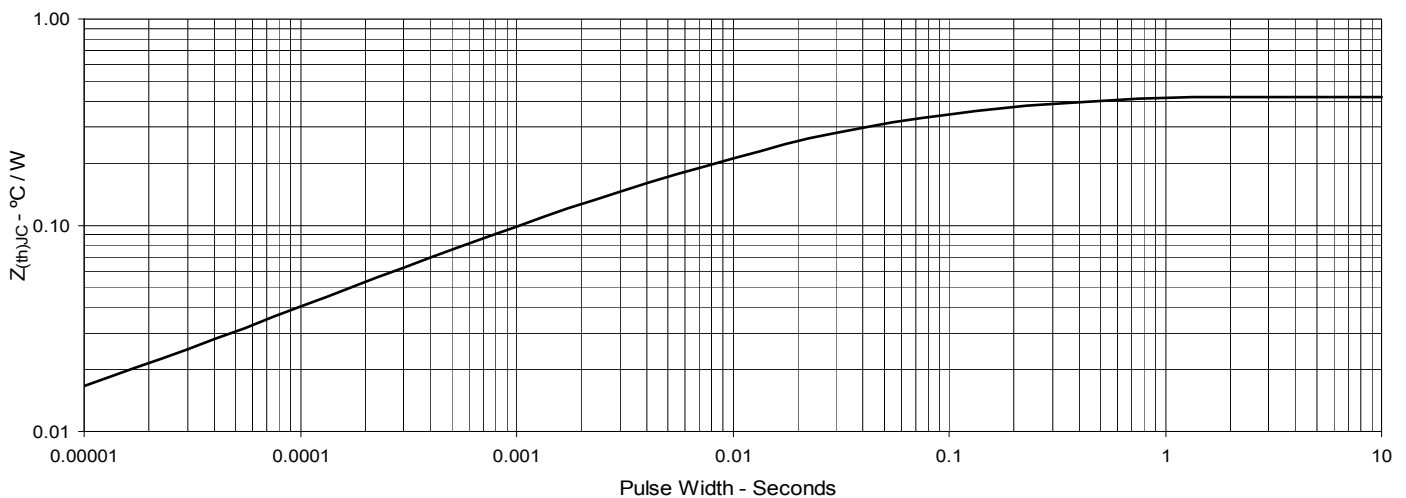
**Fig. 9. Capacitance**



**Fig. 10. Reverse-Bias Safe Operating Area**

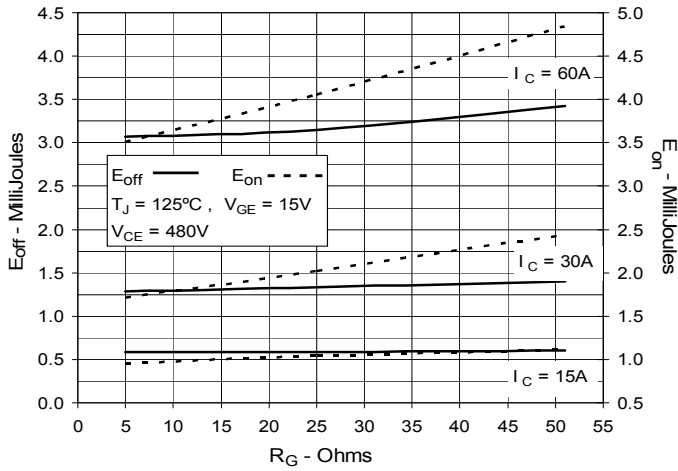


**Fig. 11. Maximum Transient Thermal Impedance**

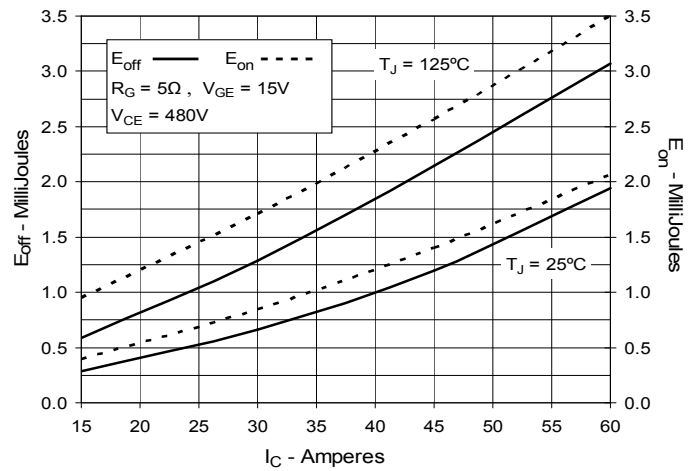


IXYS reserves the right to change limits, test conditions and dimensions.

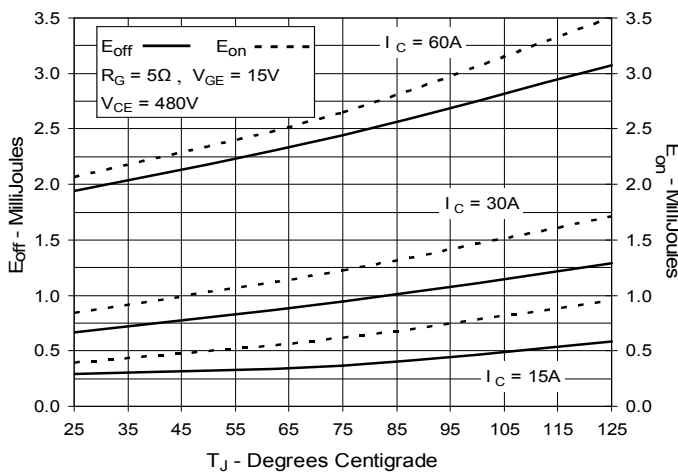
**Fig. 12. Inductive Switching Energy Loss vs. Gate Resistance**



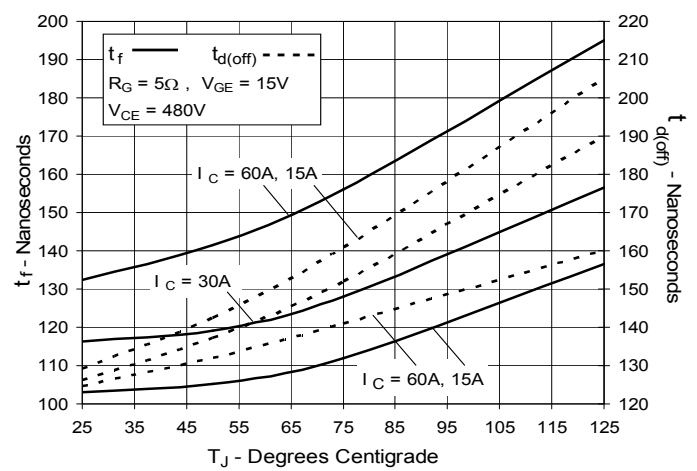
**Fig. 13. Inductive Switching Energy Loss vs. Collector Current**



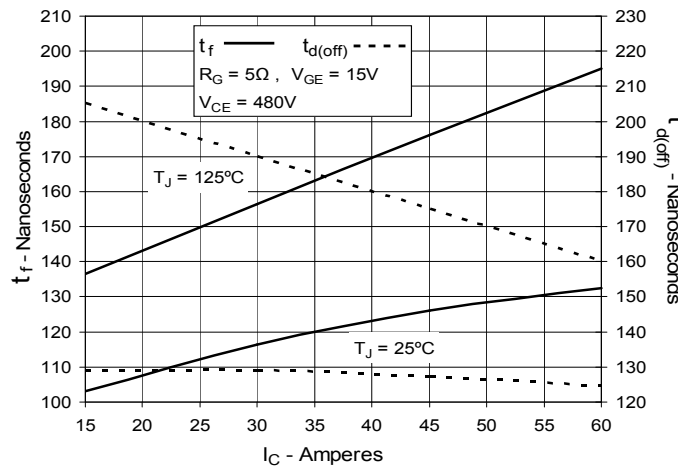
**Fig. 14. Inductive Switching Energy Loss vs. Junction Temperature**



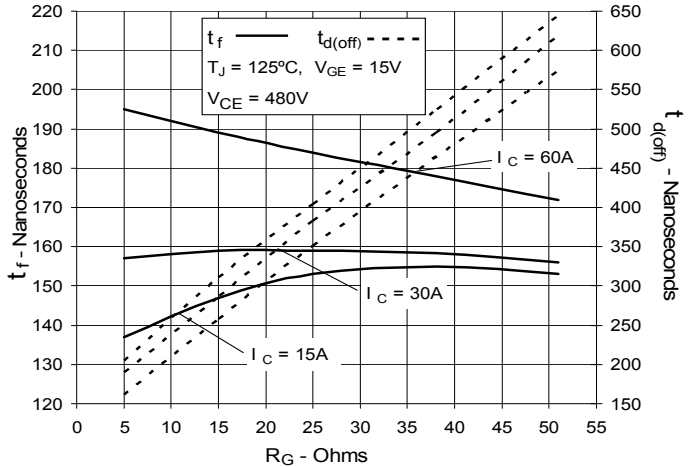
**Fig. 15. Inductive Turn-off Switching Times vs. Junction Temperature**



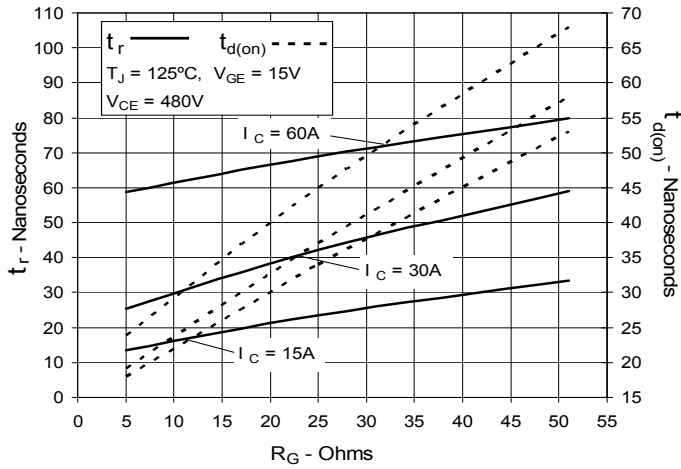
**Fig. 16. Inductive Turn-off Switching Times vs. Collector Current**



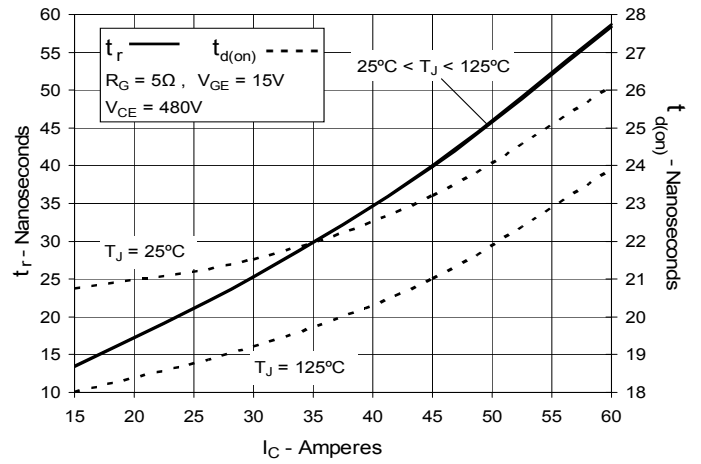
**Fig. 17. Inductive Turn-off Switching Times vs. Gate Resistance**



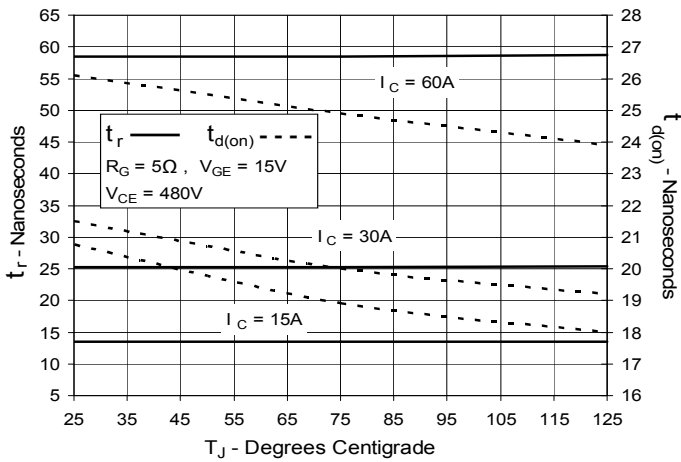
**Fig. 18. Inductive Turn-on  
Switching Times vs. Gate Resistance**



**Fig. 19. Inductive Turn-on  
Switching Times vs. Collector Current**



**Fig. 20. Inductive Turn-on  
Switching Times vs. Junction Temperature**





---

Disclaimer Notice - Information furnished is believed to be accurate and reliable. However, users should independently evaluate the suitability of and test each product selected for their own applications. Littelfuse products are not designed for, and may not be used in, all applications. Read complete Disclaimer Notice at [www.littelfuse.com/disclaimer-electronics](http://www.littelfuse.com/disclaimer-electronics).