

# Polar™ HiPerFET™ Power MOSFET

N-Channel Enhancement Mode  
Avalanche Rated  
Fast Intrinsic Diode

## IXFA6N120P IXFP6N120P IXFH6N120P

$V_{DSS} = 1200V$   
 $I_{D25} = 6A$   
 $R_{DS(on)} \leq 2.75\Omega$

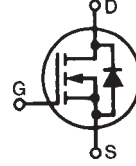

Symbol	Test Conditions	Maximum Ratings	
$V_{DSS}$	$T_J = 25^\circ C$ to $150^\circ C$	1200	V
$V_{DGR}$	$T_J = 25^\circ C$ to $150^\circ C$ , $R_{GS} = 1M\Omega$	1200	V
$V_{GSS}$	Continuous	$\pm 30$	V
$V_{GSM}$	Transient	$\pm 40$	V
$I_{D25}$	$T_C = 25^\circ C$	6	A
$I_{DM}$	$T_C = 25^\circ C$ , Pulse Width Limited by $T_{JM}$	18	A
$I_A$	$T_C = 25^\circ C$	3	A
$E_{AS}$	$T_C = 25^\circ C$	300	mJ
$dv/dt$	$I_S \leq I_{DM}$ , $V_{DD} \leq V_{DSS}$ , $T_J \leq 150^\circ C$	10	V/ns
$P_D$	$T_C = 25^\circ C$	250	W
$T_J$		-55 ... +150	$^\circ C$
$T_{JM}$		150	$^\circ C$
$T_{stg}$		-55 ... +150	$^\circ C$
$T_L$	Maximum Lead Temperature for Soldering	300	$^\circ C$
$T_{SOLD}$	1.6 mm (0.062in.) from Case for 10s	260	$^\circ C$
$F_C$	Mounting Force (TO-263)	10..65 / 2.2..14.6	N/lb
$M_d$	Mounting Torque (TO-247 & TO-220)	1.13 / 10	Nm/lb.in
<b>Weight</b>	TO-263	2.5	g
	TO-220	3.0	g
	TO-247	6.0	g

Symbol	Test Conditions ( $T_J = 25^\circ C$ , Unless Otherwise Specified)	Characteristic Values		
		Min.	Typ.	Max.
$BV_{DSS}$	$V_{GS} = 0V$ , $I_D = 250\mu A$	1200		V
$V_{GS(th)}$	$V_{DS} = V_{GS}$ , $I_D = 1mA$	2.5		5.0 V
$I_{GSS}$	$V_{GS} = \pm 30V$ , $V_{DS} = 0V$			$\pm 100$ nA
$I_{DSS}$	$V_{DS} = V_{DSS}$ , $V_{GS} = 0V$ $T_J = 125^\circ C$			10 $\mu A$ 1 mA
$R_{DS(on)}$	$V_{GS} = 10V$ , $I_D = 0.5 \cdot I_{D25}$ , Note 1			2.75 $\Omega$

### TO-263 AA (IXFA)

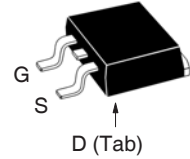

### TO-220AB (IXFP)

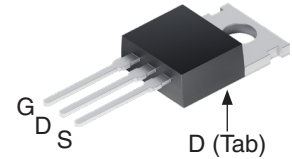

### TO-247 (IXFH)

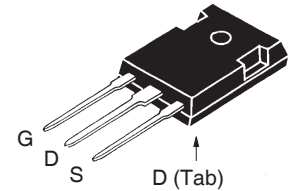

G = Gate      D = Drain  
S = Source    Tab = Drain

### Features

- International Standard Packages
- Dynamic  $dv/dt$  Rating
- Avalanche Rated
- Fast Intrinsic Diode
- Low  $Q_G$  &  $R_{DS(on)}$
- Low Drain-to-Tab Capacitance
- Low Package Inductance

### Advantages

- Easy to Mount
- Space Savings

### Applications

- DC-DC Converters
- Battery Chargers
- Switch-Mode and Resonant-Mode Power Supplies
- Uninterrupted Power Supplies
- AC Motor Drives
- High Speed Power Switching Applications

Symbol	Test Conditions ( $T_J = 25^\circ\text{C}$ , Unless Otherwise Specified)	Characteristic Values		
		Min.	Typ.	Max
$g_{fs}$	$V_{DS} = 20\text{V}$ , $I_D = 0.5 \cdot I_{D25}$ , Note 1	3.0	5.0	S
$R_{Gi}$	Gate Input Resistance		1.8	$\Omega$
$C_{iss}$	$V_{GS} = 0\text{V}$ , $V_{DS} = 25\text{V}$ , $f = 1\text{MHz}$		2830	pF
$C_{oss}$			150	pF
$C_{rss}$			30	pF
$t_{d(on)}$	<b>Resistive Switching Times</b> $V_{GS} = 10\text{V}$ , $V_{DS} = 0.5 \cdot V_{DSS}$ , $I_D = 0.5 \cdot I_{D25}$ $R_G = 3\Omega$ (External)		24	ns
$t_r$			11	ns
$t_{d(off)}$			60	ns
$t_f$			14	ns
$Q_{g(on)}$	$V_{GS} = 10\text{V}$ , $V_{DS} = 0.5 \cdot V_{DSS}$ , $I_D = 0.5 \cdot I_{D25}$		92	nC
$Q_{gs}$			15	nC
$Q_{gd}$			50	nC
$R_{thJC}$				0.50 $^\circ\text{C/W}$
$R_{thCS}$	TO-220		0.50	$^\circ\text{C/W}$
$R_{thCS}$	TO-247		0.21	$^\circ\text{C/W}$

### Source-Drain Diode

Symbol	Test Conditions ( $T_J = 25^\circ\text{C}$ , Unless Otherwise Specified)	Characteristic Values		
		Min.	Typ.	Max
$I_S$	$V_{GS} = 0\text{V}$			6 A
$I_{SM}$	Repetitive, Pulse Width Limited by $T_{JM}$			24 A
$V_{SD}$	$I_F = I_S$ , $V_{GS} = 0\text{V}$ , Note 1			1.4 V
$t_{rr}$	$I_F = 3\text{A}$ , $V_{GS} = 0\text{V}$ $-di/dt = 100\text{A}/\mu\text{s}$ $V_R = 100\text{V}$			300 ns
$I_{RM}$			7.8	A
$Q_{RM}$			1.1	$\mu\text{C}$

Note 1: Pulse test,  $t \leq 300\mu\text{s}$ , duty cycle,  $d \leq 2\%$ .

### TO-263 Outline

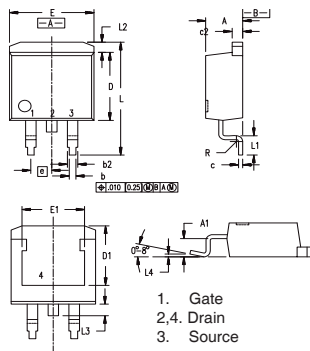

Dim.	Millimeter		Inches	
	Min.	Max.	Min.	Max.
A	4.06	4.83	.160	.190
b	0.51	0.99	.020	.039
b2	1.14	1.40	.045	.055
c	0.40	0.74	.016	.029
c2	1.14	1.40	.045	.055
D	8.64	9.65	.340	.380
D1	8.00	8.89	.280	.320
E	9.65	10.41	.380	.405
E1	6.22	8.13	.270	.320
e	2.54	BSC	.100	BSC
L	14.61	15.88	.575	.625
L1	2.29	2.79	.090	.110
L2	1.02	1.40	.040	.055
L3	1.27	1.78	.050	.070
L4	0	0.13	0	.005

1. Gate  
2,4. Drain  
3. Source

### TO-220 Outline

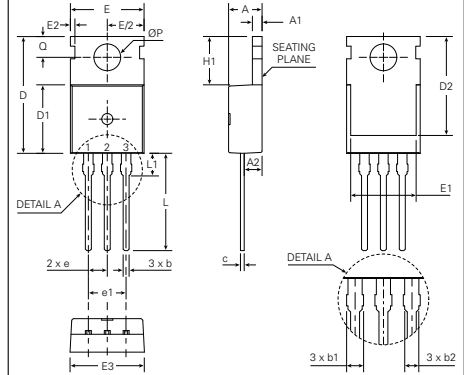

Pins: 1 - Gate  
2 - Drain  
3 - Source

Symbol	Inches			Millimeters		
	Min.	Typical	Max.	Min.	Typical	Max
A	0.169	0.177	0.185	4.30	4.50	4.70
A1	0.049	0.051	0.055	1.25	1.30	1.40
A2	0.087	0.094	0.102	2.20	2.40	2.60
b	0.028	0.031	0.035	0.70	0.80	0.90
b1	0.056	0.060	0.064	1.42	1.52	1.62
b2	0.046	0.050	0.054	1.17	1.27	1.37
c	0.018	0.020	0.024	0.45	0.50	0.60
D	0.610	0.618	0.626	15.50	15.70	15.90
D1	0.354	0.362	0.370	9.00	9.20	9.40
D2	0.516	0.524	0.531	13.10	13.30	13.50
E	0.382	0.390	0.400	9.70	9.90	10.10
E1		0.346			8.80	
E2		0.024			0.60	
E3	0.386	0.394	0.402	9.80	10.00	10.20
e		0.100			2.54 BSC	
e1		0.200			5.08 BSC	
H1	0.248	0.256	0.264	6.30	6.50	6.70
L	0.507	0.515	0.523	12.88	13.08	13.28
L1		0.118			3.00	
OP	0.134	0.142	0.150	3.40	3.60	3.80
Q	0.106	0.110	0.114	2.70	2.80	2.90

### TO-247 Outline

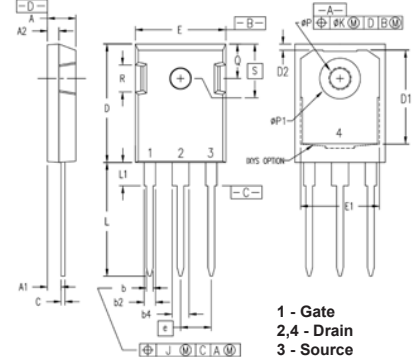

1 - Gate  
2,4 - Drain  
3 - Source

Dim.	Millimeter		Inches	
	min	max	min	max
A	4.70	5.30	0.185	0.209
A1	2.21	2.59	0.087	0.102
A2	1.50	2.49	0.059	0.098
b	0.99	1.40	0.039	0.055
b2	1.65	2.39	0.065	0.094
b4	2.59	3.43	0.102	0.135
c	0.38	0.89	0.015	0.035
D	20.79	21.45	0.819	0.845
D1	13.07	-	0.515	-
D2	0.51	1.35	0.020	0.053
E	15.48	16.24	0.610	0.640
E1	13.45	-	0.53	-
E2	4.31	5.48	0.170	0.216
e	5.45 BSC		0.215 BSC	
L	19.80	20.30	0.078	0.800
L1	-	4.49	-	0.177
OP	3.55	3.65	0.140	0.144
OP1	-	7.39	-	0.290
Q	5.38	6.19	0.212	0.244
S		6.14 BSC		0.242 BSC

Littelfuse Reserves the Right to Change Limits, Test Conditions, and Dimensions.

LF MOSFETs and IGBTs are covered by one or more of the following U.S. patents:	4,835,592	4,931,844	5,049,961	5,237,481	6,162,665	6,404,065B1	6,683,344	6,727,585	7,005,734B2	7,157,338B2
	4,860,072	5,017,508	5,063,307	5,381,025	6,259,123B1	6,534,343	6,710,405B2	6,759,692	7,063,975B2	
	4,881,106	5,034,796	5,187,117	5,486,715	6,306,728B1	6,583,505	6,710,463	6,771,478B2	7,071,537	

Fig. 1. Output Characteristics @  $T_J = 25^\circ\text{C}$

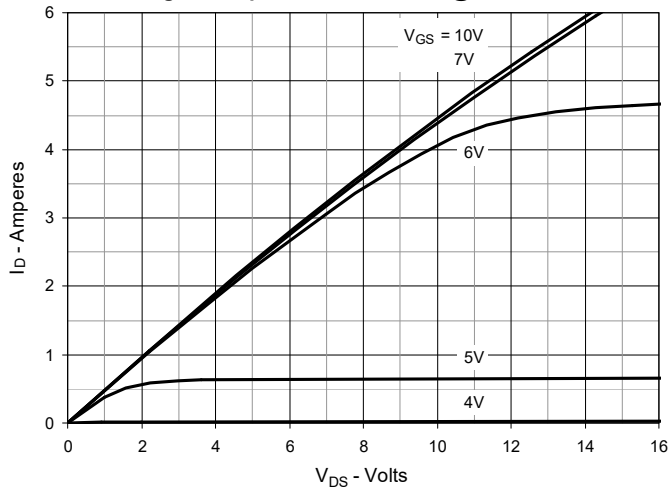

Fig. 2. Extended Output Characteristics @  $T_J = 25^\circ\text{C}$

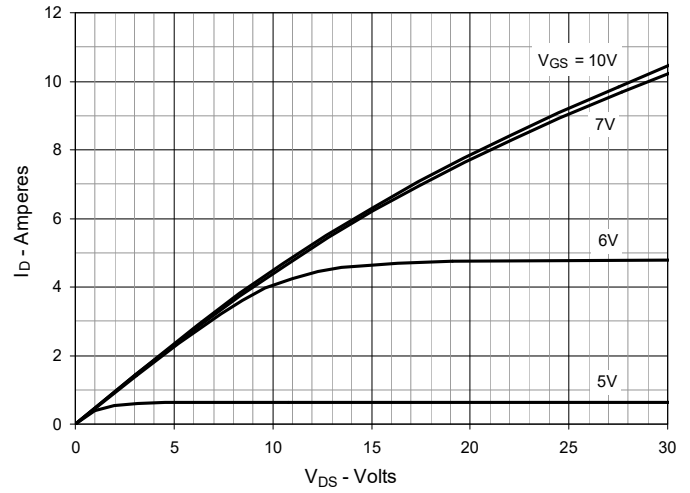

Fig. 3. Output Characteristics @  $T_J = 125^\circ\text{C}$

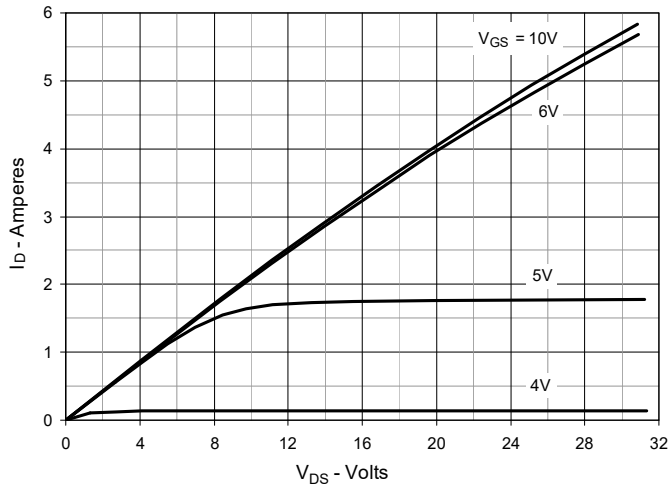

Fig. 4.  $R_{DS(on)}$  Normalized to  $I_D = 3\text{A}$  Value vs. Junction Temperature

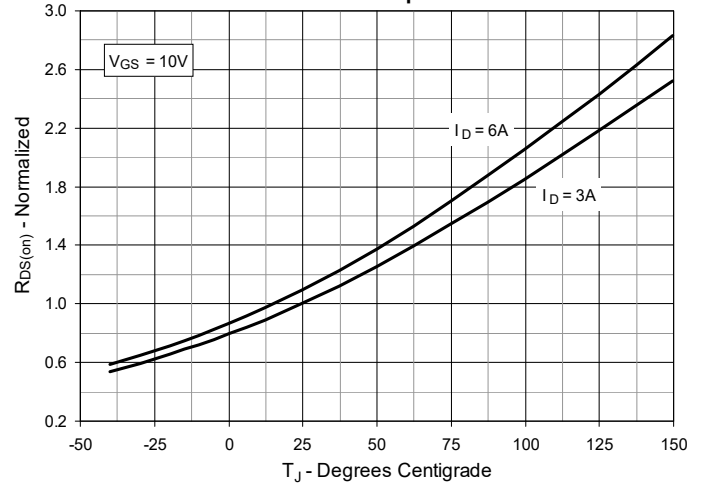

Fig. 5.  $R_{DS(on)}$  Normalized to  $I_D = 3\text{A}$  Value vs. Drain Current

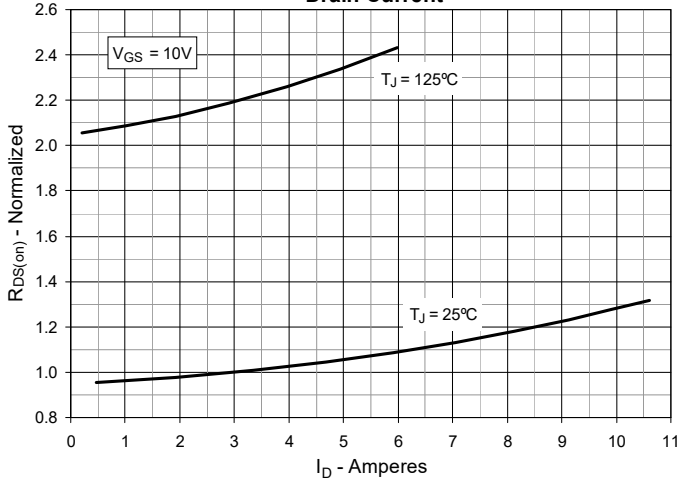

Fig. 6. Maximum Drain Current vs. Case Temperature

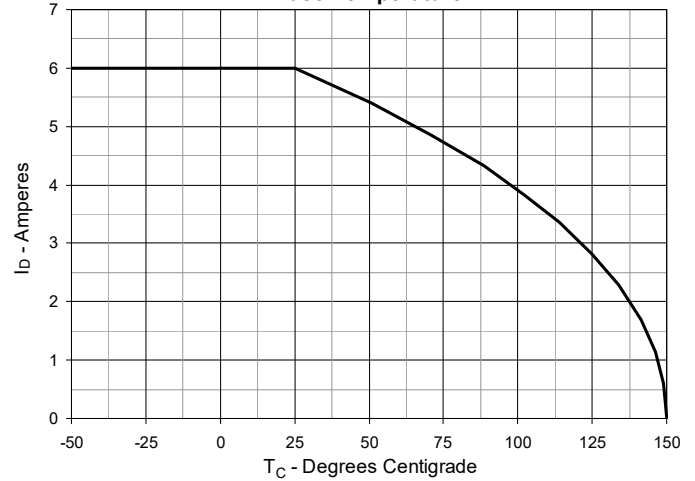

Fig. 7. Input Admittance

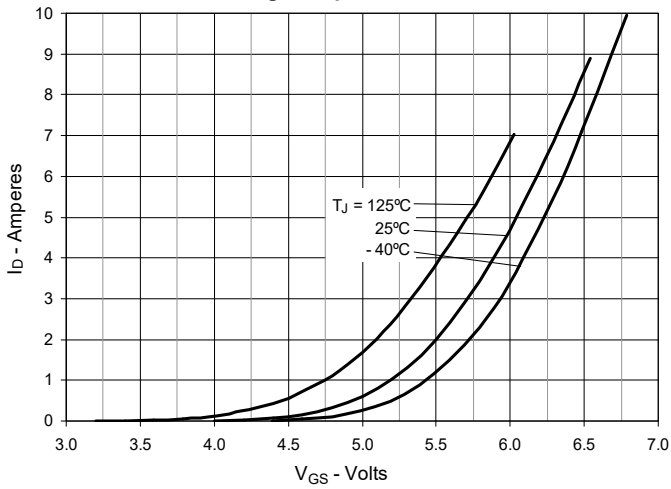

Fig. 8. Transconductance

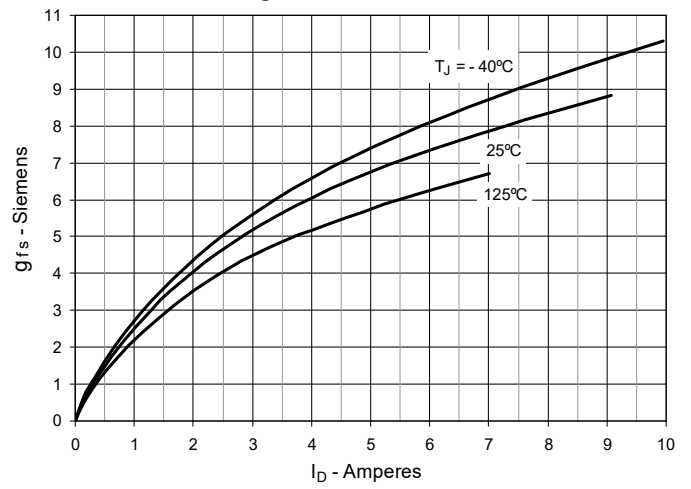

Fig. 9. Forward Voltage Drop of Intrinsic Diode

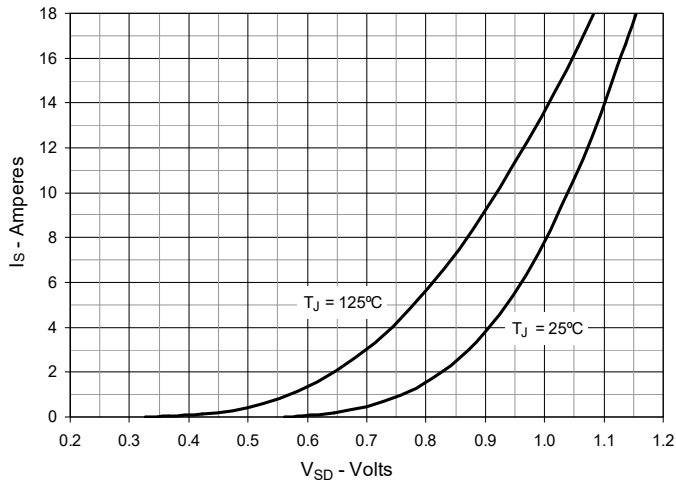

Fig. 10. Gate Charge

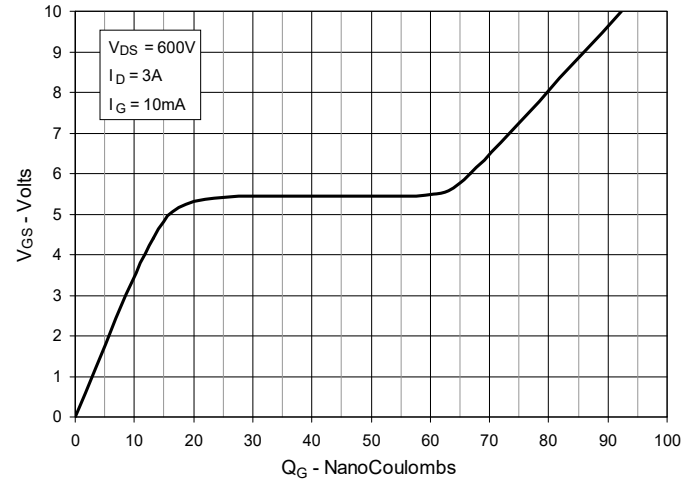

Fig. 11. Capacitance

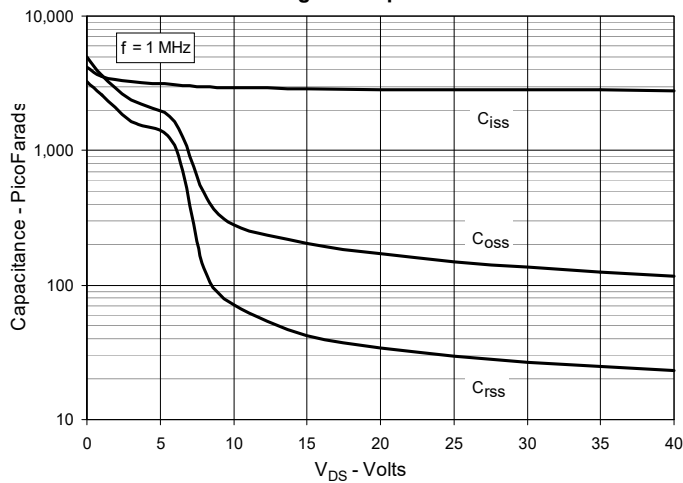
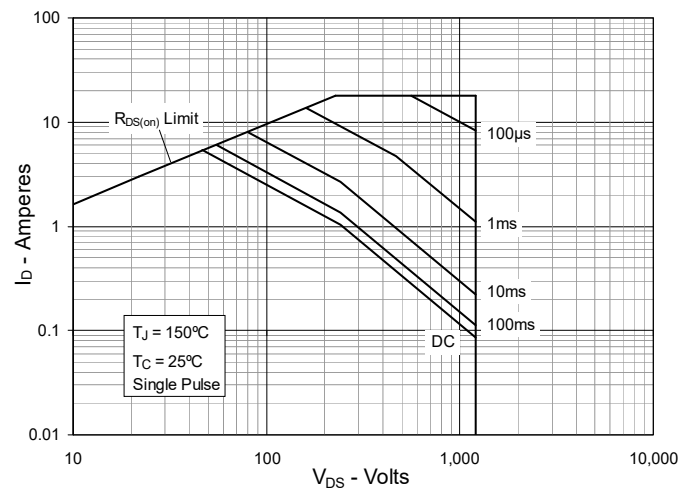
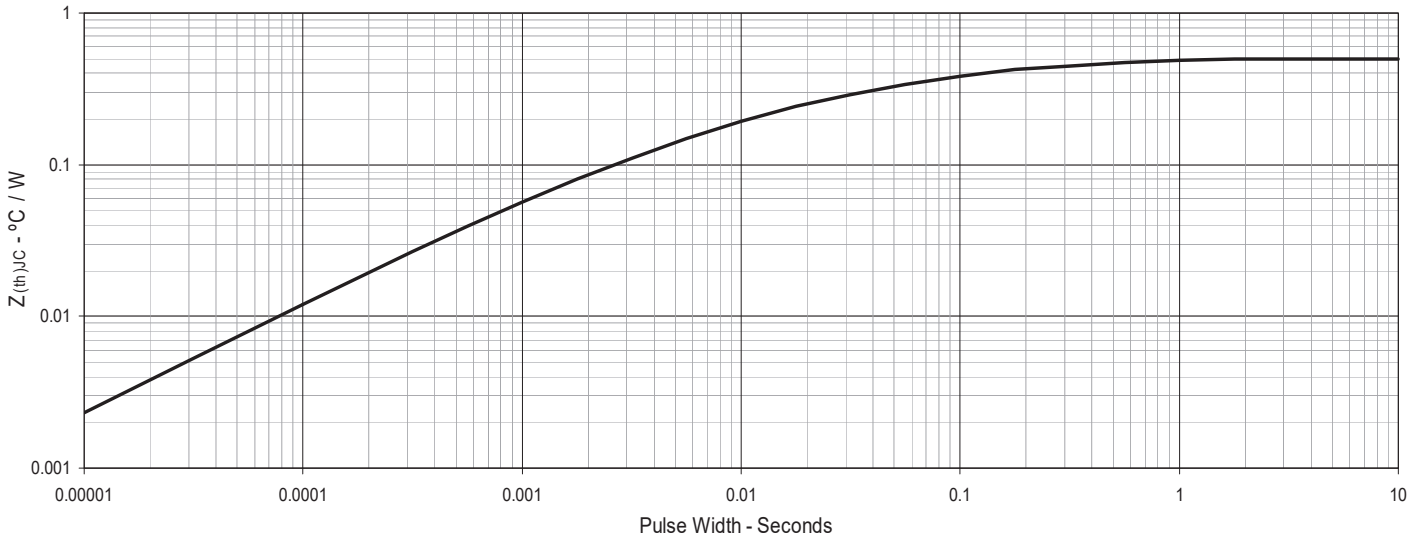

Fig. 12. Forward-Bias Safe Operating Area



**Fig. 13. Maximum Transient Thermal Impedance**



**Disclaimer Notice**

Information furnished is believed to be accurate and reliable. However, users should independently evaluate the suitability of and test each product selected for their own applications. Littelfuse products are not designed for, and may not be used in, all applications. Read complete Disclaimer Notice at <http://www.littelfuse.com/disclaimer-electronics>.



Part of:

