



### CG6 Series



#### Agency Approvals

AGENCY	AGENCY FILE NUMBER
	E128662
	E320116

#### Two Electrode GDT Graphical Symbol



#### Additional Information



**Datasheet**



**Resources**



**Samples**

#### Description

The Littelfuse CG6 series GDT is a miniature surface-mount device with a 3kA 8/20 surge rating. This ITU-T K.12 Class 1, Type 1 GDT provides protection against fast rising transients typically caused by nearby lightning events. Its low insertion loss and thus low off-state capacitance makes it compatible with high bandwidth applications up to the GHz RF range. This GDT's crowbaring characteristic protects sensitive ICs from surges as defined in ITU K.20/21/45 Basic and Enhanced Recommendations, GR-1089-CORE first level lightning Port Type 1,3, and 5, and IEC 61000-4-5, 2<sup>nd</sup> edition Level 5 and below. It is hermetically sealed using non-radioactive materials and is thus environmentally safe.

#### Features

- RoHS compliant and Lead-free
- Excellent Surge Withstanding Capability
- Excellent response to fast rising transients.
- Ultra Low Insertion Loss and low off-state capacitance for GHz bandwidth compatibility
- 3kA 8/20µs surge capability
- Compact SMD package offered in two squared terminals
- Non-Radioactive
- Ultra Low capacitance (<0.3pF)
- Voltage Range 75V to 600V
- UL recognized
- Characterized according to ITU-T K.12 as a Class X, Type 1 GDT

#### Applications

- Broadband equipment
- CATV/Broadband equipment
- Data lines and Ethernet (up to 10GbE)
- xDSL equipment, including ADSL2, ADSL, VDSL, VDSL2 30a bandplan compatible
- IAD (Integrated Access Device)
- Set Top Box (STB)
- General telecom equipment
- Embedded Multimedia Terminal Adapter (EMTA)
- RF Connector
- Multimedia over Coax Alliance (MoCA)
- Base Station RF antenna transmitter
- G.Fast 106MHz and 212 MHz bandplans compatible
- Aerospace and Automotive

**Electrical Characteristics**

Part Number	Device Specifications (at 25°C)						Life Ratings						
	DC Breakdown in Volts (@100V/s)			Impulse Break-down in Volts (@100V/μs)	Impulse Break-down In Volts (@1 kV/μs)	Insulation Resistance	Capacitance (@1MHz)	Max Impulse Discharge Current (8/20μs)	Max Impulse Discharge Current (10/700μs)	AC Discharge Current (50Hz, 1sec)	AC Discharge Current (Single, 9 Cycles)	DC Holdover Voltage (<150ms)	Impulse Life (10/1000μs) (50A)
	MIN	TYP	MAX	MAX		MIN	MAX			MIN	MIN		MIN
CG675	60	75	90	600	700	1GΩ @50V	0.3pf	10 Shots @ (3kA) <sup>1</sup>	10 Shots @ (150A/6kV) <sup>2</sup>	3A	6A	52V	300 Shots
CG690	72	90	108	600	700							52V	
CG6145	116	145	174	600	700	1GΩ @100V	1 Shot at 5kA					52V	
CG6230	186	230	276	600	700							80V	
CG6250	200	250	300	600	700							80V	
CG6300	240	300	360	650	800							135V	
CG6350	280	350	420	750	900							135V	
CG6400	360	400	480	850	1000							135V	
CG6470	376	470	564	900	1100							135V	
CG6600	480	600	720	1000	1200							1GΩ@250V	

Note:  
1. 5 x (+) and 5 x (-) applications of 3kA 8/20μs sec.  
2. 5 x (+) and 5 x (-) applications of 150A 10/700μs sec.

**Product Characteristics**

<b>Materials</b>	Device Tin Plated 17.5 ± 12.5 Microns Construction: Ceramic Insulator
<b>Storage and Operational Temperature</b>	-40 to +90°C

**Voltage Vs. Time Characteristic**

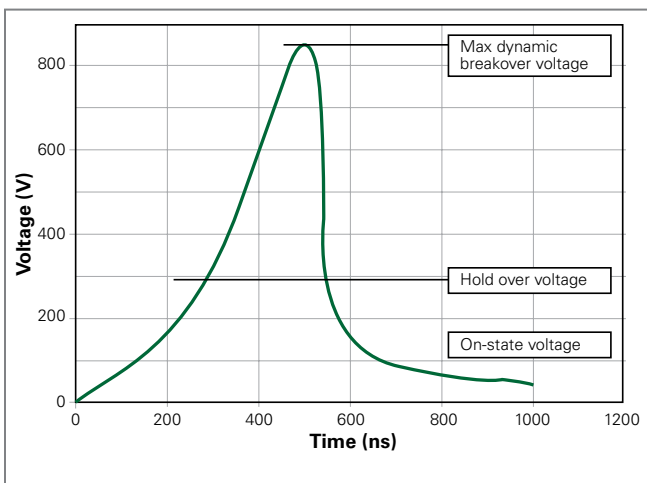

Note: Tested per 1kV/μs waveform

**Typical Insertion Loss**

@1.0GHz = 0.03dB
@1.4GHz = 0.06dB
@1.8GHz = 0.09dB
@2.0GHz = 0.11dB
@2.4GHz = 0.13dB
@2.8GHz = 0.15dB
@3.1GHz = 0.17dB
@3.5GHz = 0.19dB
@4.0GHz = 0.22dB

Note: Insertion data for customer reference only, application testing needed for verification.

**V-I Characteristic Curve**

Characteristics of Gas Plasma -response to transient condition

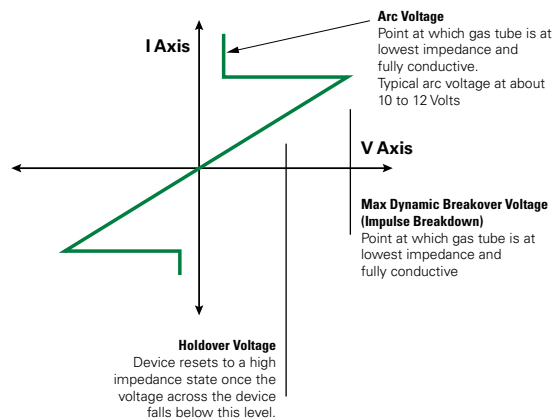

### Soldering Parameters - Reflow Soldering (Surface Mount Devices)

Reflow Condition		Pb – Free assembly
Pre Heat	- Temperature Min ( $T_{s(min)}$ )	150°C
	- Temperature Max ( $T_{s(max)}$ )	200°C
	- Time (Min to Max) ( $t_s$ )	60 – 180 secs
Average ramp up rate (Liquidus Temp ( $T_L$ ) to peak)		3°C/second max
$T_{s(max)}$ to $T_L$ - Ramp-up Rate		5°C/second max
Reflow	- Temperature ( $T_L$ ) (Liquidus)	217°C
	- Temperature ( $t_L$ )	60 – 150 seconds
Peak Temperature ( $T_p$ )		260 <sup>+0/-5</sup> °C
Time within 5°C of actual peak Temperature ( $t_p$ )		10 – 30 seconds
Ramp-down Rate		6°C/second max
Time 25°C to peak Temperature ( $T_p$ )		8 minutes Max.
Do not exceed		260°C

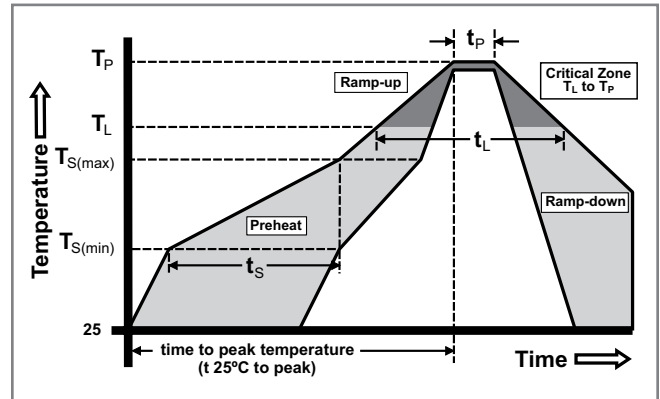

### Device Dimensions

Dimensions in millimeters

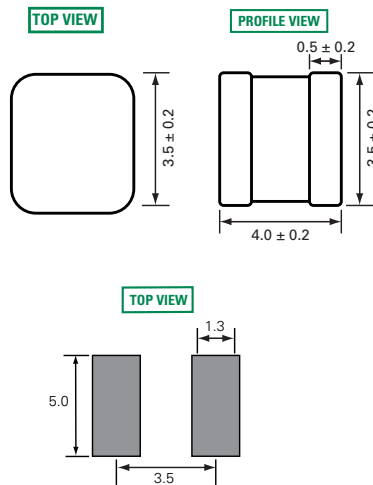

Recommended Soldering Pad Layout

### Product Marking

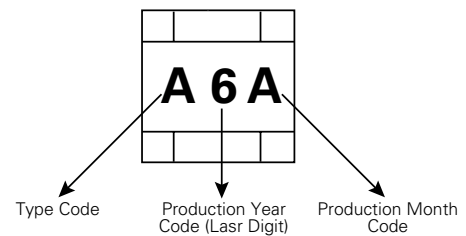

Type Code	
A	CG675
B	CG690
S	CG6145
D	CG6230
R	CG6250
E	CG6300
G	CG6350
I	CG6400
P	CG6470
V	CG6600

Month Code	
A	January
B	February
C	March
D	April
E	May
F	June
G	July
H	August
I	September
J	October
K	November
L	December

**Taping and Reel Specifications**

Unit = mm

Item	Spec	Item	Spec
P	8.0 ± 0.1	E	1.75 ± 0.1
P0	4.0 ± 0.1	D	1.50 + 0.1/-0.0
P2	2.0 ± 0.1	B0	4.5 ± 0.1
W	12.0 ± 0.3	K0	3.9 ± 0.1
F	5.5 ± 0.1	T	0.4 ± 0.1
A0	3.9 ± 0.1	10P0	4.0 ± 0.2

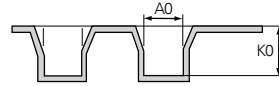
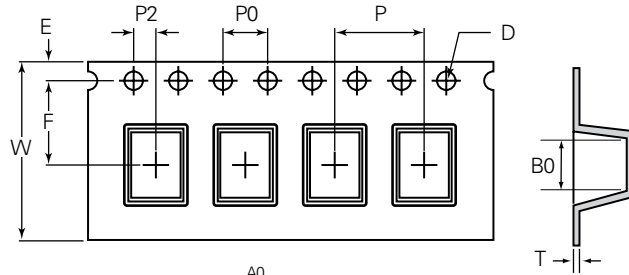

**Packaging Quantity:**  
2000 pcs per reel (13")  
1 reels per inner box  
10 inners box per carton  
20,000 pcs per full carton

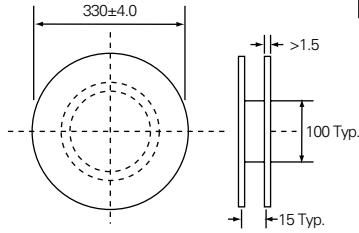

**Part Numbering System and Ordering Information**

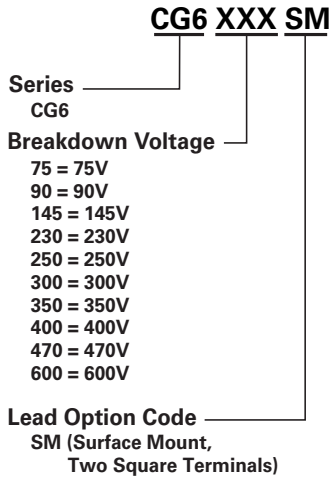

**Disclaimer Notice** - Information furnished is believed to be accurate and reliable. However, users should independently evaluate the suitability of and test each product selected for their own applications. Littelfuse products are not designed for, and may not be used in, all applications. Read complete Disclaimer Notice at: [www.littelfuse.com/disclaimer-electronics](http://www.littelfuse.com/disclaimer-electronics).