

LPWI Series

Surface Mount

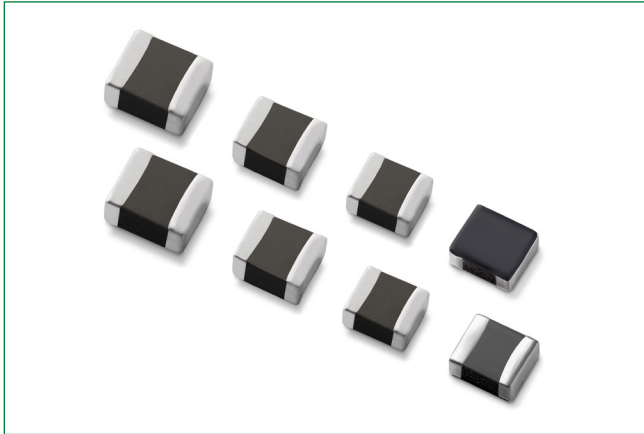

Description

The Littelfuse LPWI Series provides voltage stabilization in a compact design. With its low losses, high efficiency, high durability, and excellent temperature saturation characteristics, the LPWI Series is ideal for small battery operated applications.

Features & Benefits

- Thin film photolithography technology
- Compact and low profile
- Metal alloy composite material
- High current capability
- High efficiency
- Low DC resistance
- Magnetically shielded
- Space saving
- Energy efficient
- Reliable

Additional Information



Resources



Accessories



Samples

Applications

- DC-DC converters and power modules in general use electronic equipment
- Smartphone and tablets
- Wearable devices
- Virtual and augmented reality equipments
- Powerbanks
- Printers

LPWI Series

Surface Mount

Electrical Characteristics

Part Number	Size (mm)	Size (Inch)	Thickness (mm)	Inductance@ 1MHz [uH]	DC Resistance [mΩ]		Rated DC Current (A)			
					Typ.	Max.	Isat, ΔL/L=30%		Itemp, ΔT=40°C	
							Typ.	Max.	Typ.	Max.
LPWI160808SR24T	1608	0603	0.8	0.24 ± 20%	30	40	3.2	2.8	3.2	2.8
LPWI160808SR47T	1608	0603	0.8	0.47 ± 20%	35	50	2.8	2.5	3.0	2.7
LPWI160808HR47T	1608	0603	0.8	0.47 ± 20%	37	45	3.4	3.1	3.2	2.9
LPWI160808S1R0T	1608	0603	0.8	1.00 ± 20%	130	150	2.0	1.7	2.0	1.7
LPWI160808H1R0T	1608	0603	0.8	1.00 ± 20%	115	135	2.2	2.0	2.0	1.7
LPWI201208SR24T	2012	0805	0.8	0.24 ± 20%	17	22	4.8	4.5	4.1	3.9
LPWI201208SR47T	2012	0805	0.8	0.47 ± 20%	30	35	4.2	4.0	4.0	3.8
LPWI201208HR47T	2012	0805	0.8	0.47 ± 20%	30	35	5.0	4.7	4.0	3.8
LPWI201208SR68T	2012	0805	0.8	0.68 ± 20%	58	65	3.4	3.1	2.8	2.5
LPWI201208S1R0T	2012	0805	0.8	1.00 ± 20%	60	65	3.4	3.1	3.0	2.7
LPWI201208S1R5T	2012	0805	0.8	1.50 ± 20%	110	120	2.3	2.0	2.1	1.9
LPWI201210SR47T	2012	0805	1.0	0.47 ± 20%	25	33	4.7	4.5	4.2	4.0
LPWI201210HR47T	2012	0805	1.0	0.47 ± 20%	25	28	5.4	4.9	4.5	4.3
LPWI201210S1R0T	2012	0805	1.0	1.00 ± 20%	50	60	3.5	3.2	3.0	2.7
LPWI201608NR24T	2016	0806	0.8	0.24 ± 20%	20	25	5.0	4.6	4.2	3.8
LPWI201608HR47T	2016	0806	0.8	0.47 ± 20%	21	27	5.0	4.7	4.1	4.0
LPWI201608H1R0T	2016	0806	0.8	1.00 ± 20%	45	50	3.9	3.6	3.5	3.2
LPWI201608S1R0T	2016	0806	0.8	1.00 ± 20%	50	65	3.3	2.9	3.0	2.6
LPWI201608S1R0T	2016	0806	0.8	1.50 ± 20%	90	120	2.9	2.3	2.1	1.9
LPWI201608S2R2T	2016	0806	0.8	2.20 ± 20%	130	150	2.0	1.6	1.9	1.5
LPWI201610SR47T	2016	0806	1.0	0.47 ± 20%	35	40	4.2	3.5	3.7	3.2
LPWI201610HR47T	2016	0806	1.0	0.47 ± 20%	20	25	5.0	4.5	4.2	3.6
LPWI201610BR47T	2016	0806	1.0	0.47 ± 20%	21	27	5.7	5.5	5.2	4.8
LPWI201610SR68T	2016	0806	1.0	0.68 ± 20%	40	50	4.1	3.7	3.5	3.1
LPWI201610S1R0T	2016	0806	1.0	1.00 ± 20%	58	65	3.2	2.8	3.0	2.6
LPWI201610H1R0T	2016	0806	1.0	1.00 ± 20%	40	45	3.9	3.6	3.1	2.7
LPWI201610B1R0T	2016	0806	1.0	1.00 ± 20%	40	43	4.2	4.0	3.5	3.2
LPWI201610H1R5T	2016	0806	1.0	1.50 ± 20%	85	100	2.7	2.5	2.5	2.3
LPWI201610B2R2T	2016	0806	1.0	2.20 ± 20%	117	140	2.6	2.4	2.1	1.9
LPWI201610S2R2T	2016	0806	1.0	2.20 ± 20%	135	150	2.2	1.8	2.3	1.9
LPWI201610H2R2T	2016	0806	1.0	2.20 ± 20%	115	135	2.7	2.5	2.4	2.2
LPWI252010SR33T	2520	1008	1.0	0.33 ± 20%	20	25	6.8	6.3	5.8	5.3
LPWI252010BR47T	2520	1008	1.0	0.47 ± 20%	21	27	6.4	6.0	5.2	4.6
LPWI252010SR47T	2520	1008	1.0	0.47 ± 20%	25	30	6.0	5.5	4.1	3.7
LPWI252010HR47T	2520	1008	1.0	0.47 ± 20%	22	27	6.6	6.0	5.2	4.4
LPWI252010NR68T	2520	1008	1.0	0.68 ± 20%	32	37	5.5	5.0	4.1	3.5
LPWI252010B1R0T	2520	1008	1.0	1.00 ± 20%	33	36	5.0	4.7	4.3	4.0
LPWI252010S1R0T	2520	1008	1.0	1.00 ± 20%	40	50	4.2	3.8	3.5	3.1
LPWI252010H1R0T	2520	1008	1.0	1.00 ± 20%	35	45	4.6	4.1	3.8	3.5
LPWI252010S1R5T	2520	1008	1.0	1.50 ± 20%	65	80	3.5	3.1	2.8	2.5
LPWI252010B2R2T	2520	1008	1.0	2.20 ± 20%	85	95	3.5	3.1	2.5	2.3
LPWI252010S2R2T	2520	1008	1.0	2.20 ± 20%	100	110	3.0	2.5	2.5	2.3
LPWI252010H2R2T	2520	1008	1.0	2.20 ± 20%	90	97	3.5	3.1	2.5	2.3
LPWI252010S3R3T	2520	1008	1.0	3.30 ± 20%	155	170	2.2	2.0	1.9	1.6
LPWI252010S4R7T	2520	1008	1.0	4.70 ± 20%	230	245	1.9	1.6	1.8	1.5

LPWI Series

Surface Mount

Electrical Characteristics (Continued)

Part Number	Size (mm)	Size (Inch)	Thickness (mm)	Inductance@ 1MHz [uH]	DC Resistance [mΩ]		Rated DC Current (A)			
					Typ.	Max.	Isat, ΔL/L=30%		Itemp, ΔT=40°C	
							Typ.	Max.	Typ.	Max.
LPWI201610TR47T	2016	0806	1.0	0.47 ± 20%	20	25	5.3	4.8	4.2	3.6
LPWI201610TAR47T	2016	0806	1.0	0.47 ± 20%	35	40	4.2	3.5	3.7	3.2
LPWI201610TBR47T	2016	0806	1.0	0.47 ± 20%	21	27	6.0	5.7	5.2	4.8
LPWI201610T1R0T	2016	0806	1.0	1.00 ± 20%	58	65	3.2	2.8	3.0	2.6
LPWI201610TA1R0T	2016	0806	1.0	1.00 ± 20%	40	45	3.9	3.6	3.1	2.7
LPWI201610TB1R0T	2016	0806	1.0	1.00 ± 20%	43	46	4.2	4.0	3.5	3.2

Note: These PNs have top cover

Test Conditions:

- Inductance measuring equipment : 4287A RF LCR meter, (Agilent) at 1MHz , 0.5V
- DC Resistance measuring equipment : 4338B Milliohm meter (Agilent)
- Withstand voltage : Absolute maximum voltage DC 20V
- Rated Current "ΔL/L=30%" : Based on the inductance change rate (30% below the initial L value)
- Rated Current "ΔT=40°C" : Based on the temp. increase (40°C by self heating at. room-temperature)

LPWI Series

Surface Mount

Inductive Vs. Frequency Characteristics

1.6 x 0.8 x 0.8 mm size

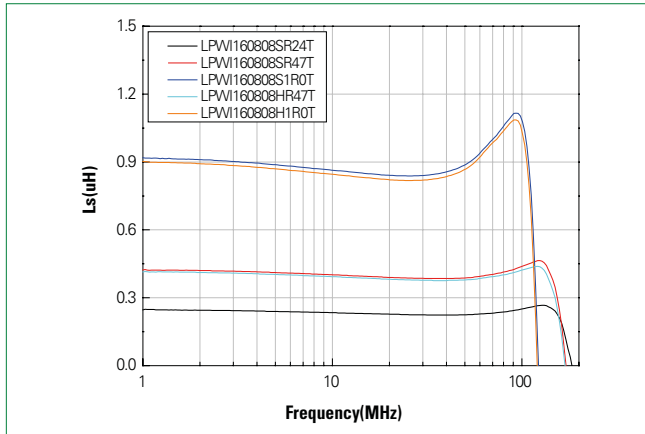

Inductive Vs. DC Current Characteristics

1.6 x 0.8 x 0.8 mm size

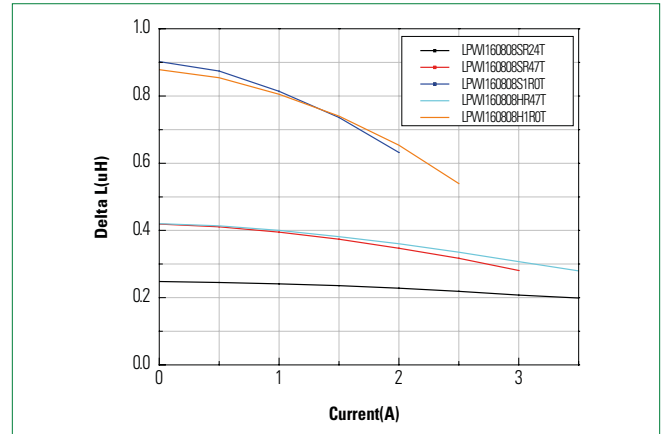

Inductive Vs. Frequency Characteristics

2.0 x 1.2 x 0.8 mm size

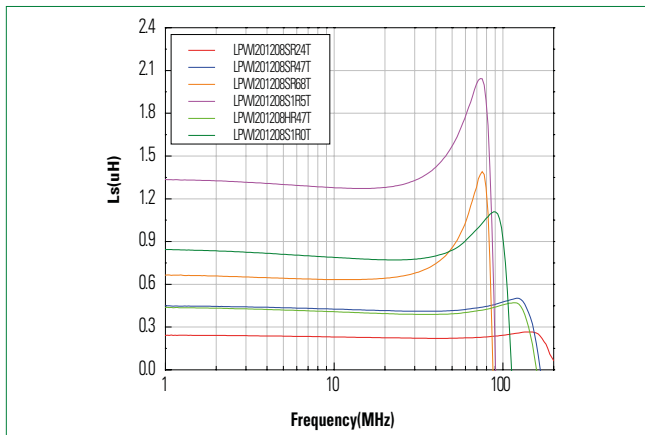

Inductive Vs. DC Current Characteristics

2.0 x 1.2 x 0.8 mm size

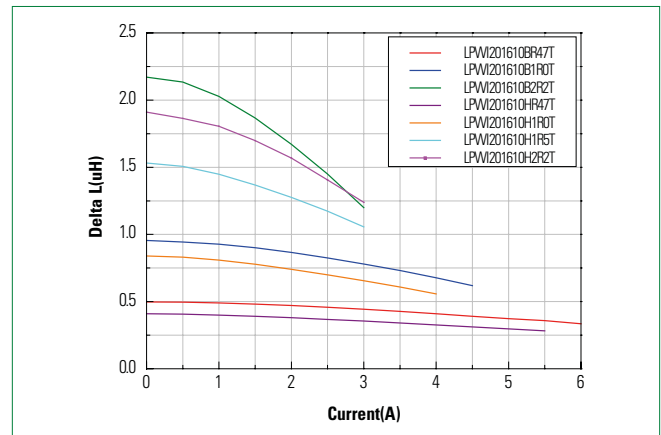

Inductive Vs. Frequency Characteristics

2.0 x 1.2 x 1.0 mm size

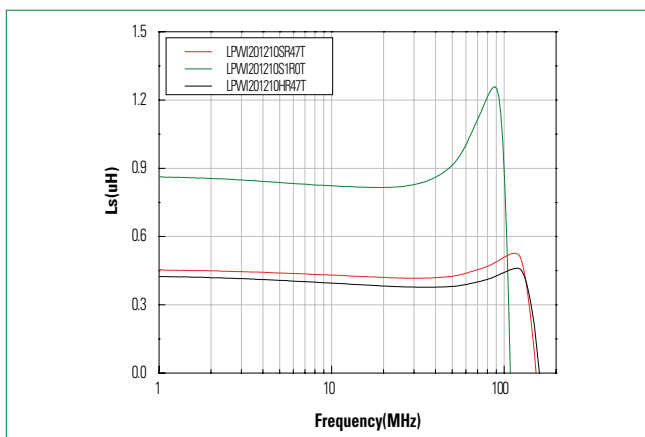

Inductive Vs. DC Current Characteristics

2.0 x 1.2 x 1.0 mm size

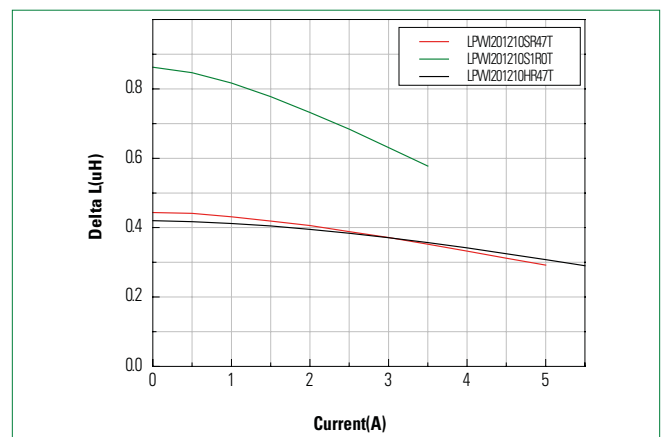

LPWI Series

Surface Mount

Inductive Vs. Frequency Characteristics
2.0 x 1.6 x 0.8 mm size

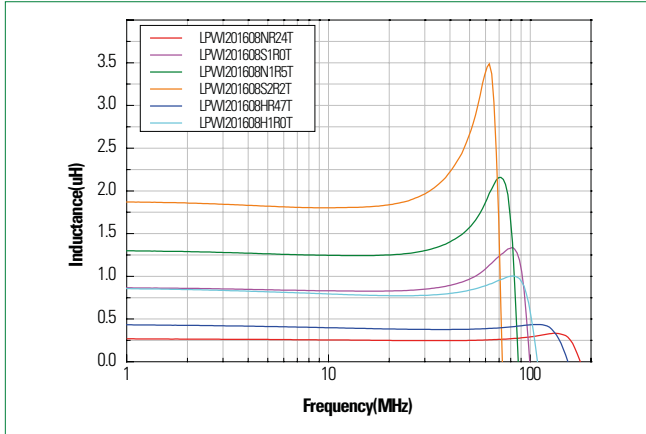

Inductive Vs. DC Current Characteristics
2.0 x 1.6 x 0.8 mm size

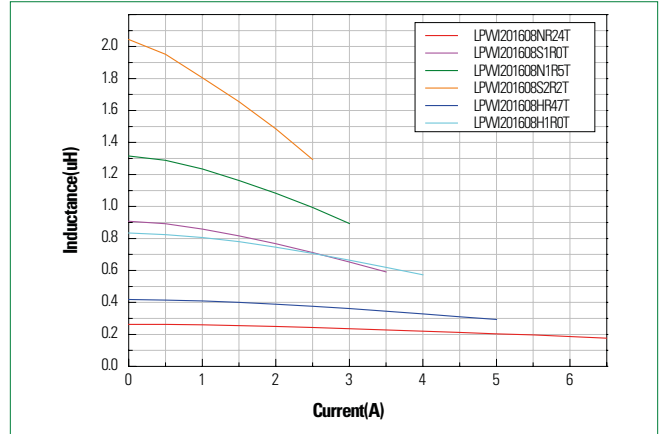

Inductive Vs. Frequency Characteristics
2.0 x 1.6 x 1.0 mm size

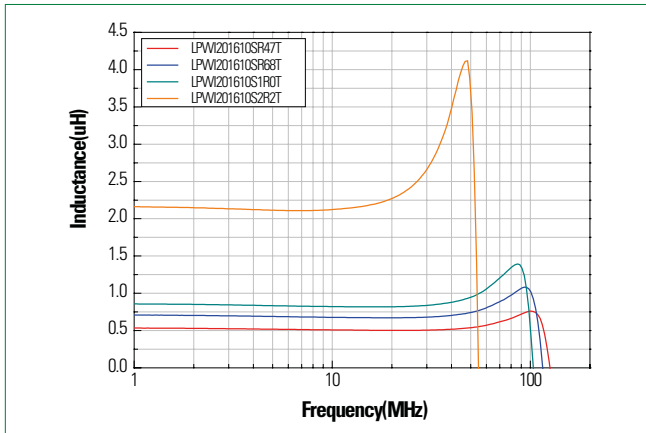

Inductive Vs. DC Current Characteristics
2.0 x 1.6 x 1.0 mm size

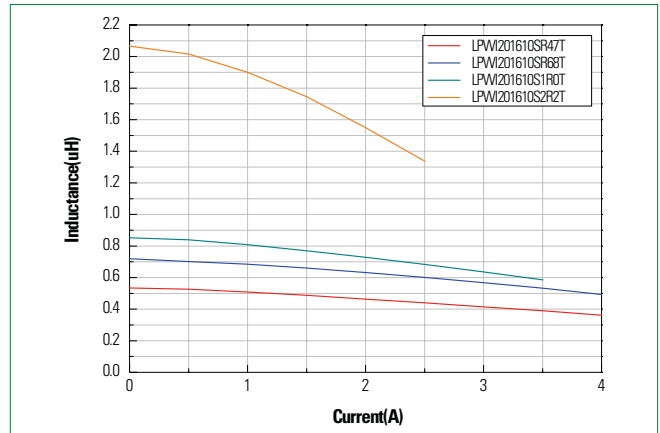

Inductive Vs. Frequency Characteristics
2.0 x 1.6 x 1.0 mm size (High Current)

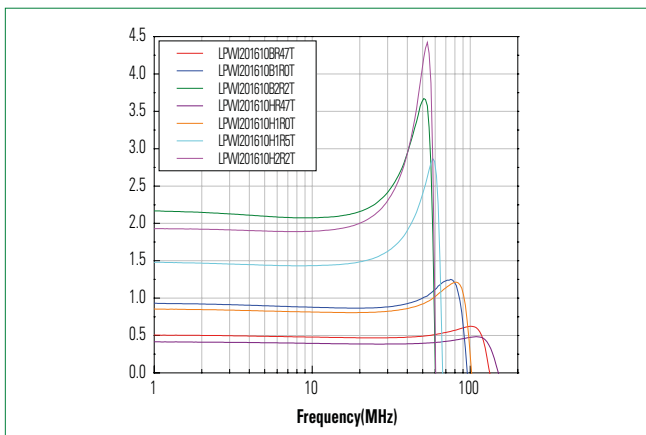

Inductive Vs. DC Current Characteristics
2.0 x 1.6 x 1.0 mm size (High Current)

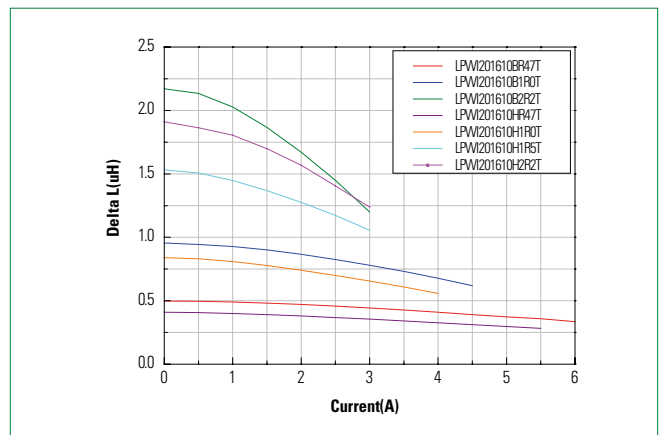

LPWI Series

Surface Mount

Inductive Vs. Frequency Characteristics
2.0 x 1.6 x 1.0 mm size (top cover type)

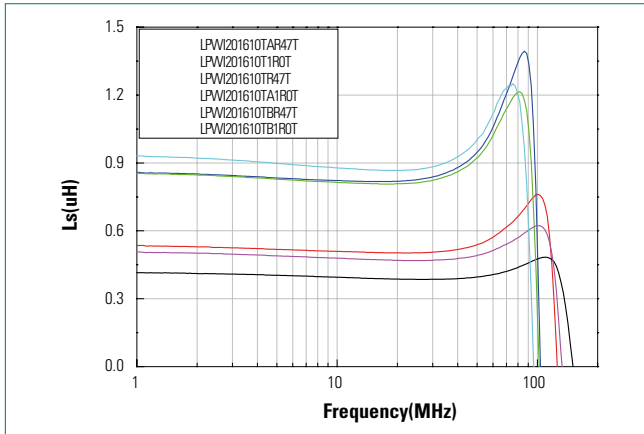

Inductive Vs. DC Current Characteristics
2.0 x 1.6 x 1.0 mm size (top cover type)

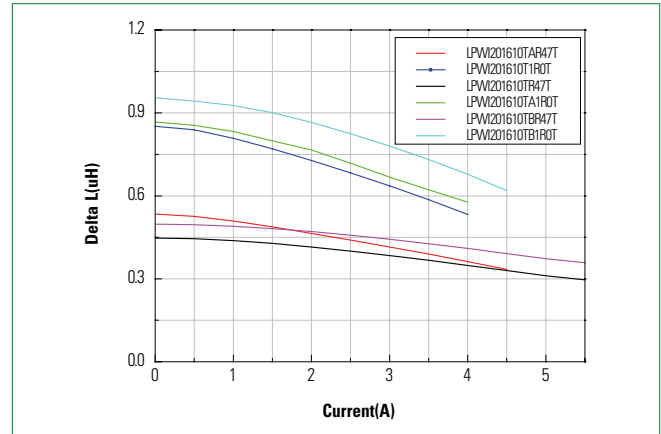

Inductive Vs. Frequency Characteristics
2.5 x 2.0 x 1.0 mm size

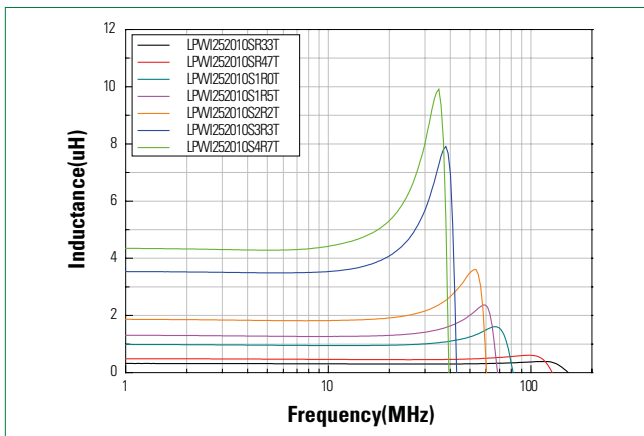

Inductive Vs. DC Current Characteristics
2.5 x 2.0 x 1.0 mm size

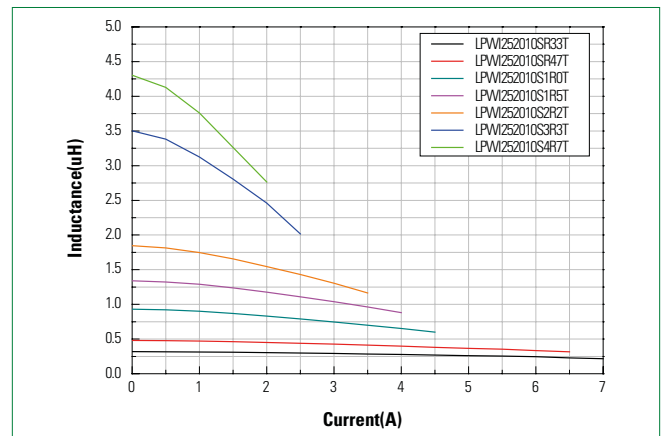

Inductive Vs. Frequency Characteristics
2.5 x 2.0 x 1.0 mm size (High Current)

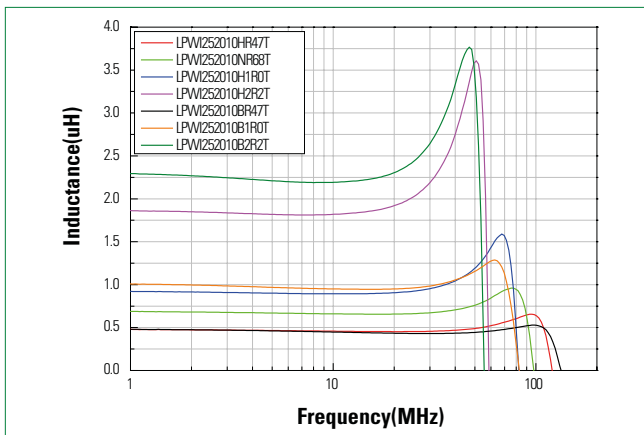

Inductive Vs. DC Current Characteristics
2.5 x 2.0 x 1.0 mm size (High Current)

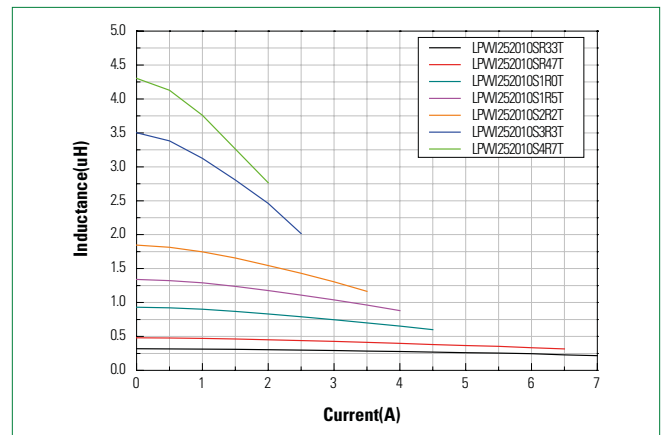

Test Conditions:
 ■ Test Equipment: 4991A RF Impedance Analyzer (Agilent)
 ■ Test Frequency: 1MHz ~ 200MHz

LPWI Series

Surface Mount

Inductive Vs. Frequency Characteristics

Reflow Condition	Pb-free assembly	
Pre Heat	- Temperature Min ($T_{s(min)}$)	160°C
	- Temperature Max ($T_{s(max)}$)	185°C
	- Time (Min to Max) (t_s)	100 – 120 seconds
Average Ramp-up Rate (Liquidus Temp (T_L) to peak)	1°C/second max	
$T_{s(max)}$ to T_L - Ramp-up Rate	1°C/second max	
Reflow	- Temperature (T_L) (Liquidus)	220°C
	- Temperature (t_L)	30 – 50 seconds
Peak Temperature (T_p)	260°C	
Time within 5°C of actual peak Temperature (t_p)	5~10 seconds	
Ramp-down Rate	2°C/second max	
Time 25°C to Peak Temperature (T_p)	4 minutes max	
Do not exceed	260°C	
Wave Soldering	260°C, 10 sec. max	

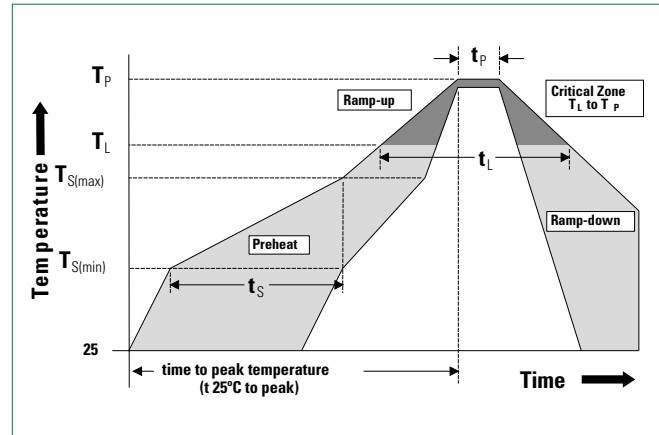

Inductive Vs. Frequency Characteristics

Lead Pull Strength	5N
Solderability	260°C, ≤10s (Reflow), Max 380°C, ≤5s (Soldering iron)
Soldering Heat Resistance	Max 260°C 10sec (Wave), Max Temperature: Max 380°C (Max 5sec)
Operating Temperature	-40°C ~ + 125°C
Climatic Category	-40°C ~ + 85°C/8 days
Stock Conditions	-10°C ~ + 40°C RH, ≤ 70%
Vibration Resistance	5 g's for 20 minutes, 12 cycles each of 3 orientations

LPWI Series

Surface Mount

Dimensions

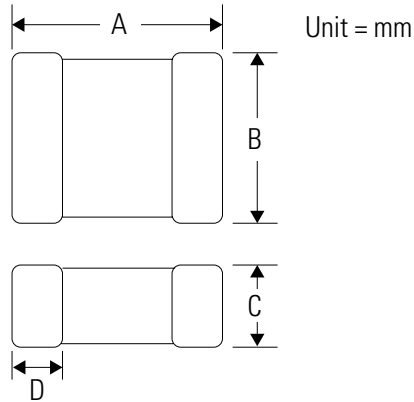

Recommended Footprint and Stencil Mask

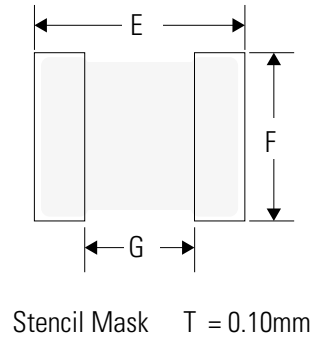

Part Number	A	B	C (max.)	D	E	F	G
LPWI160808SR24T	1.60±0.20	0.80±0.20	0.80	0.30±0.20	1.80+0.10	1.00+0.10	0.80±0.10
LPWI160808SR47T							
LPWI160808S1R0T							
LPWI160808HR47T	1.70±0.10	0.90±0.10	0.7±0.10	0.30±0.20	1.80+0.10	1.00+0.10	0.80±0.10
LPWI160808H1R0T							
LPWI201208SR24T							
LPWI201208SR68T	2.00±0.20	1.20±0.20	0.8	0.50±0.30	2.40+0.10	1.45+0.10	0.80±0.10
LPWI201208S1R5T							
LPWI201208SR47T							
LPWI201208S1R0T							
LPWI201208HR47T							
LPWI201210SR47T							
LPWI201210HR47T	2.00±0.20	1.20±0.20	0.9±0.10	0.50±0.30	2.40+0.10	1.45+0.10	0.80±0.10
LPWI201210S1R0T							
LPWI201608LR24T							
LPWI201608NR24T	2.00±0.20	1.60±0.20	0.8	0.40±0.10	2.40+0.10	1.80+0.10	1.00±0.10
LPWI201608N1R5T							
LPWI201608HR47T							
LPWI201608H1R0T							
LPWI201608S1R0T							
LPWI201608S2R2T							

LPWI Series

Surface Mount

Dimensions

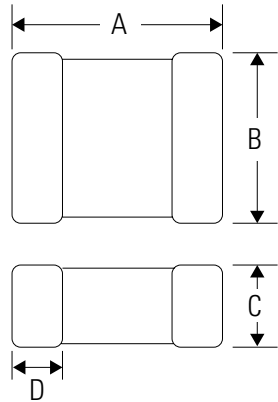

Unit = mm

Recommended Footprint and Stencil Mask

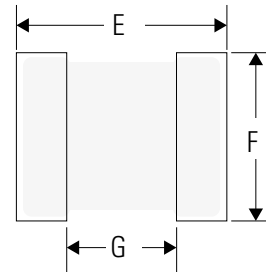

Stencil Mask T = 0.10mm

Part Number	A	B	C (max.)	D	E	F	G
LPWI201610HR47T	2.00±0.20	1.60±0.20	0.90±0.10	0.50±0.30	2.40+0.10	1.80+0.10	1.00±0.10
LPWI201610BR47T							
LPWI201610SR47T							
LPWI201610H1R0T							
LPWI201610B1R0T							
LPWI201610S1R0T							
LPWI201610H1R5T							
LPWI201610B2R2T							
LPWI201610S2R2T							
LPWI201610H2R2T							
LPWI201610SR68T							
LPWI252010SR47T							
LPWI252010BR47T							
LPWI252010NR68T							
LPWI252010S1R0T							
LPWI252010B1R0T							
LPWI252010H1R0T							
LPWI252010B2R2T							
LPWI252010S2R2T							
LPWI252010H2R2T							
LPWI252010S4R7T							
LPWI252010SR33T							
LPWI252010S1R5T	2.50±0.20	2.00±0.20	1.00	0.50±0.30	2.80+0.10	2.20+0.10	1.20±0.10
LPWI252010S3R3T							

LPWI Series

Surface Mount

Dimensions

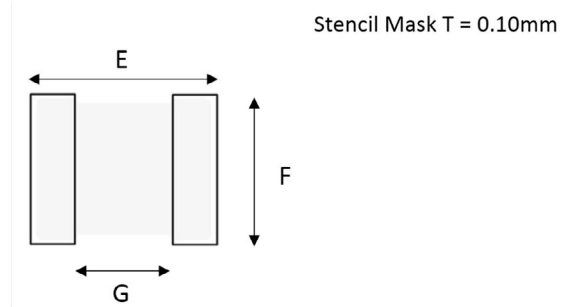
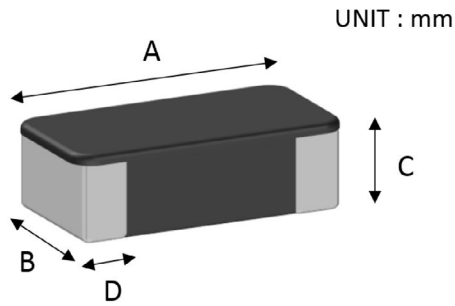

Part Number	A	B	C (max.)	D	E	F	G
LPWI201610TR47T	2.00±0.20	1.60±0.20	1	0.50±0.30	2.40+0.10	1.80+0.10	1.00±0.10
LPWI201610TAR47T							
LPWI201610TBR47T							
LPWI201610T1R0T							
LPWI201610TA1R0T							
LPWI201610TB1R0T							

Special Notice: Above PNs have top cover; no ground

LPWI Series

Surface Mount

Carrier Tape Dimensions

1608mm, 0.8T

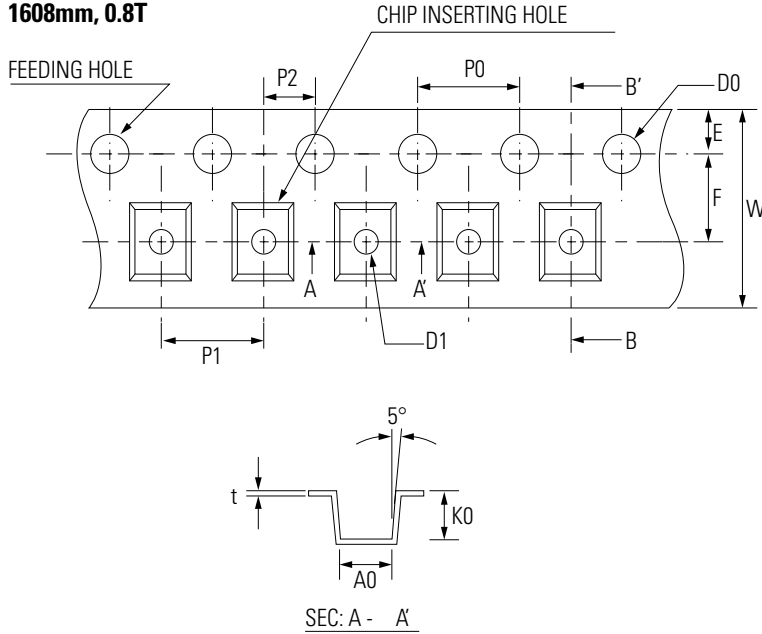

Symbol	Dimensions	
	Millimeters	
A0	1.14±0.05	
B0	1.95±0.05	
W	8.00±0.10	
F	3.50±0.05	
E	1.75±0.05	
P1	4.00±0.10	
P2	2.00±0.05	
P0	4.00±0.10	
D0	1.55±0.03	
t	0.22±0.05	

Tape and Reel Dimensions

1608mm, 0.8T

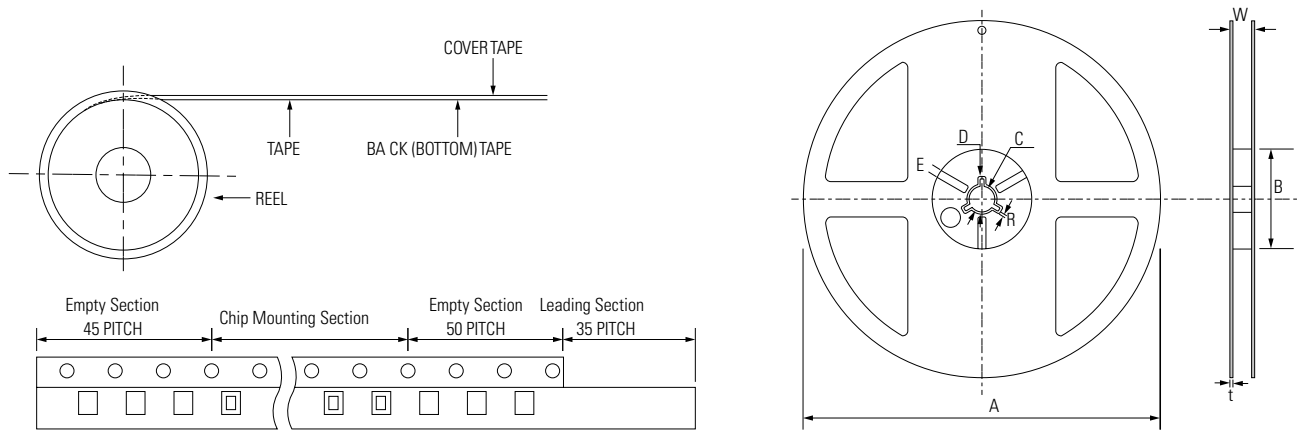

- (1) Reel Materials: Polystyrene (2) Label (3) Taping
- Standard Packing Quantity per Reel (Ø178)
- PE Tape: 4,000pcs

Code	A	B	C	D	E	W	t	R
Dimension	Ø178±2	Min. Ø50	Ø13±0.5	Ø20±0.8	3.0±0.5	10±1.5	1.3±0.2	1.0±0.2

LPWI Series

Surface Mount

Carrier Tape Dimensions

2012mm, 0.8T

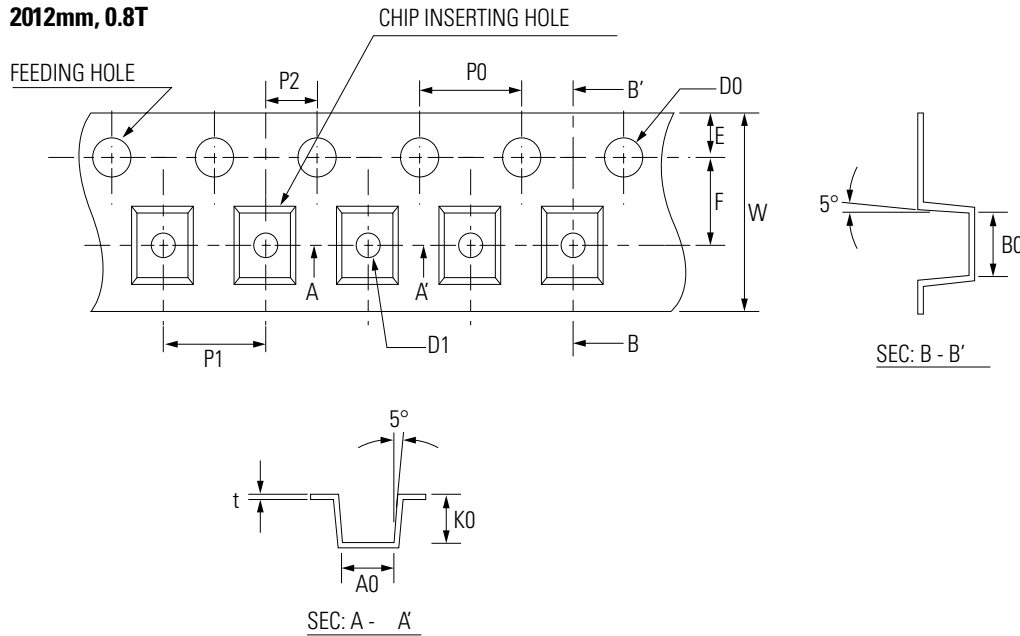

Symbol	Dimensions
	Milimeters
A0	1.50±0.05
B0	2.35±0.05
K0	0.90±0.05
W	8.00±0.02
F	3.50±0.05
E	1.75±0.10
P1	4.00±0.10
P2	2.00±0.05
P0	4.00±0.05
D0	1.50+0.10 & -0
D1	1.00±0.05
t	0.25±0.05

Tape and Reel Dimensions

2012mm, 0.8T

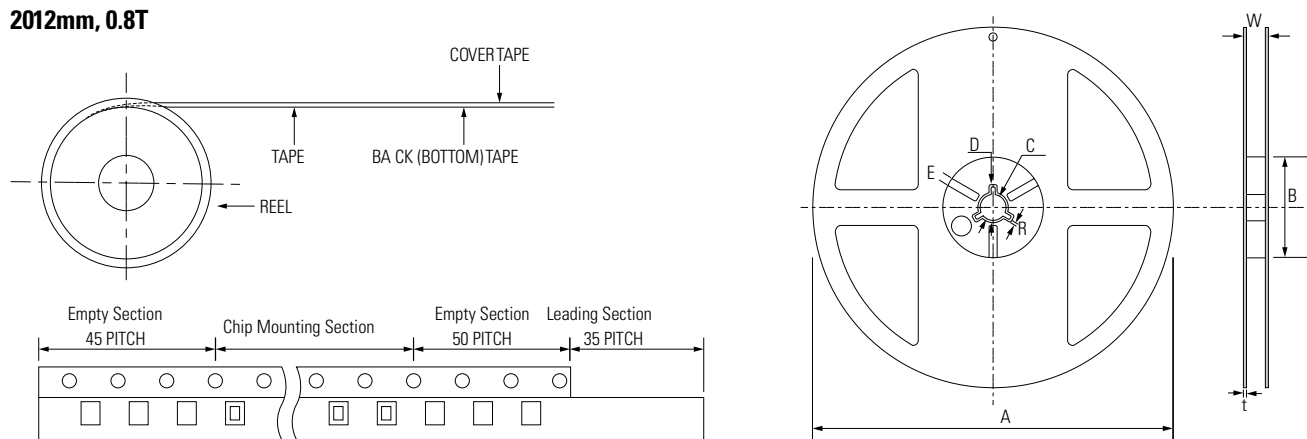

- (1) Reel Materials: Polystyrene (2) Label (3) Taping
- Standard Packing Quantity per Reel (Ø178)
- PE Tape: 3,000pcs

Code	A	B	C	D	E	W	t	R
Dimension	Ø178±2	Min. Ø50	Ø13±0.5	Ø20±0.8	3.0±0.5	10±1.5	1.3±0.2	1.0±0.2

LPWI Series

Surface Mount

Carrier Tape Dimensions

2012mm, 1.0T

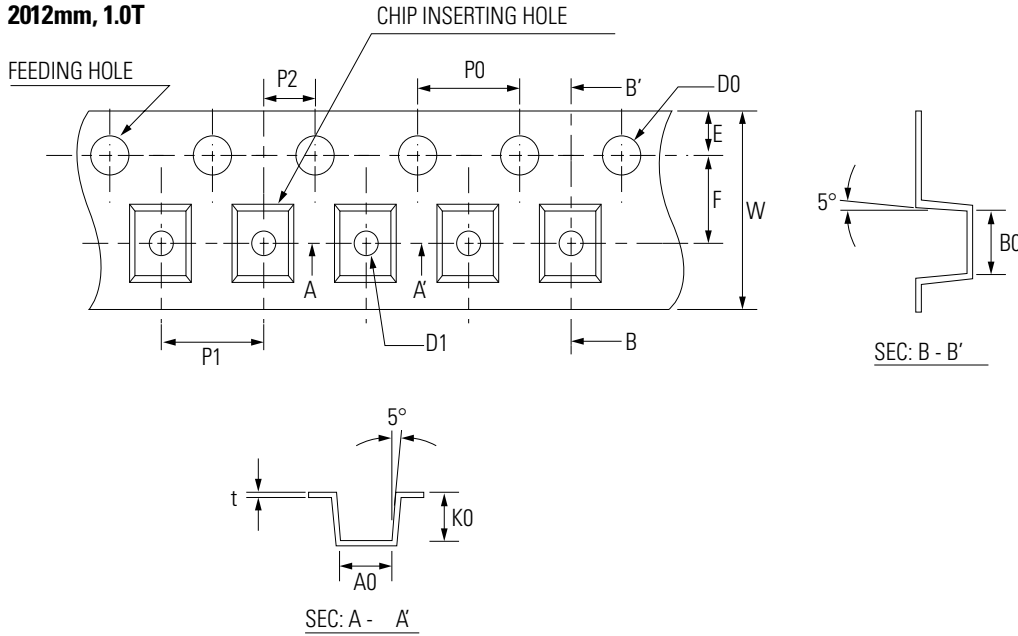

Symbol	Dimensions
	Milimeters
A0	1.42±0.10
B0	2.35±0.05
K0	1.09±0.05
W	8.00±0.2
F	3.50±0.05
E	1.75±0.10
P1	4.00±0.10
P2	2.00±0.05
P0	4.00±0.05
D0	1.50+0.10 & -0
D1	1.00±0.10
t	0.22±0.05

Tape and Reel Dimensions

2012mm, 1.0T

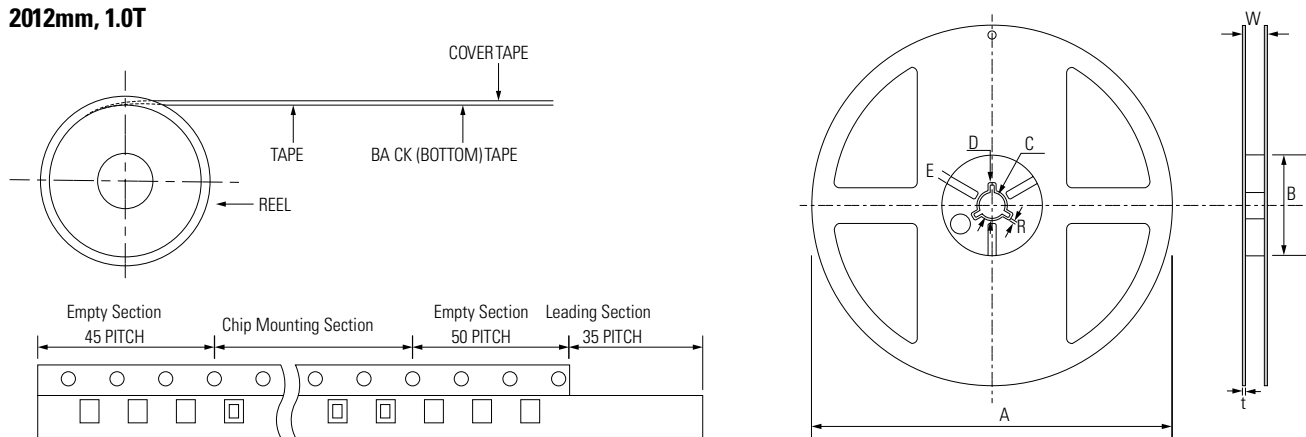

- (1) Reel Materials: Polystyrene (2) Label (3) Taping
- Standard Packing Quantity per Reel (Ø178)
- PE Tape: 3,000pcs

Code	A	B	C	D	E	W	t	R
Dimension	Ø178±2	Min. Ø50	Ø13±0.5	Ø20±0.8	3.0±0.5	10±1.5	1.3±0.2	1.0±0.2

LPWI Series

Surface Mount

Carrier Tape Dimensions

2016mm, 0.8T

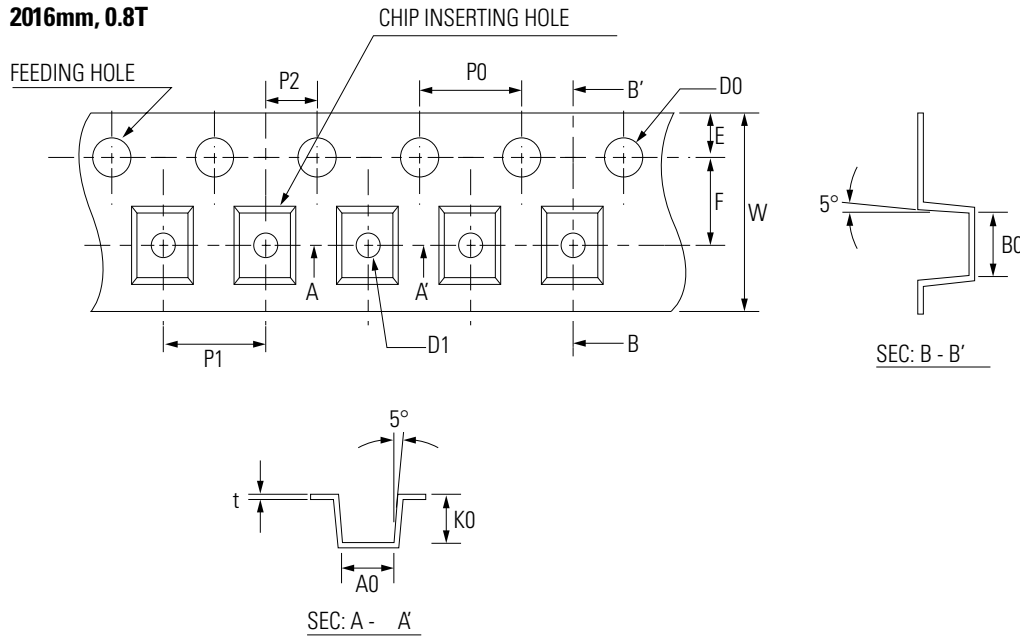

Symbol	Dimensions
	Milimeters
A0	1.90±0.10
B0	2.35±0.10
K0	1.15±0.10
W	8.00±0.2
F	3.50±0.05
E	1.75±0.10
P1	4.00±0.10
P2	2.00±0.05
P0	4.00±0.05
D0	1.50+0.10 & -0
D1	1.00±0.10
t	0.22±0.05

Tape and Reel Dimensions

2016mm, 0.8T

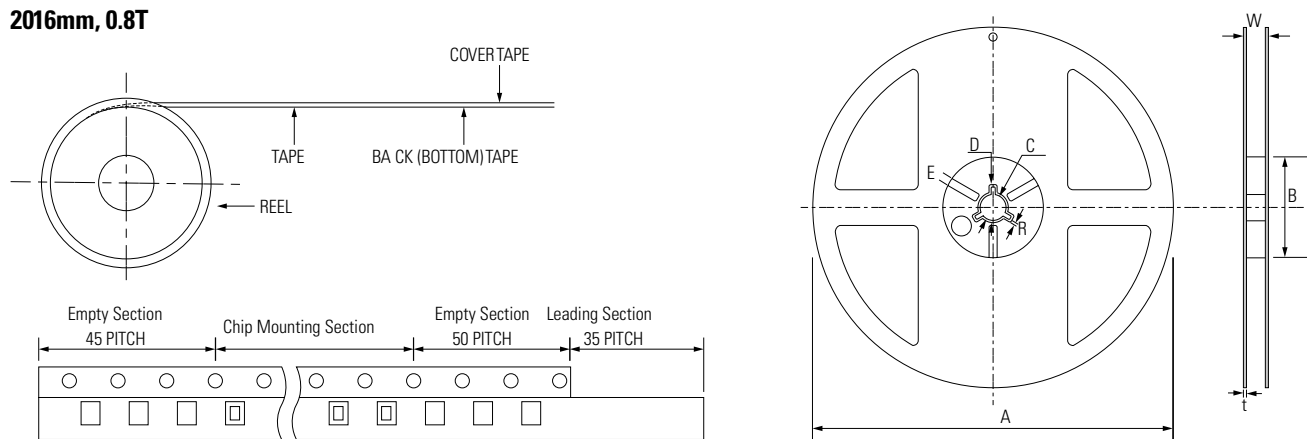

- (1) Reel Materials: Polystyrene (2) Label (3) Taping
- Standard Packing Quantity per Reel (Ø178)
- PE Tape: 3,000pcs

Code	A	B	C	D	E	W	t	R
Dimension	Ø178±2	Min. Ø50	Ø13±0.5	Ø21±0.8	2.0±0.5	10±1.5	0.8±0.2	1.0

LPWI Series

Surface Mount

Carrier Tape Dimensions

2016mm, 1.0T

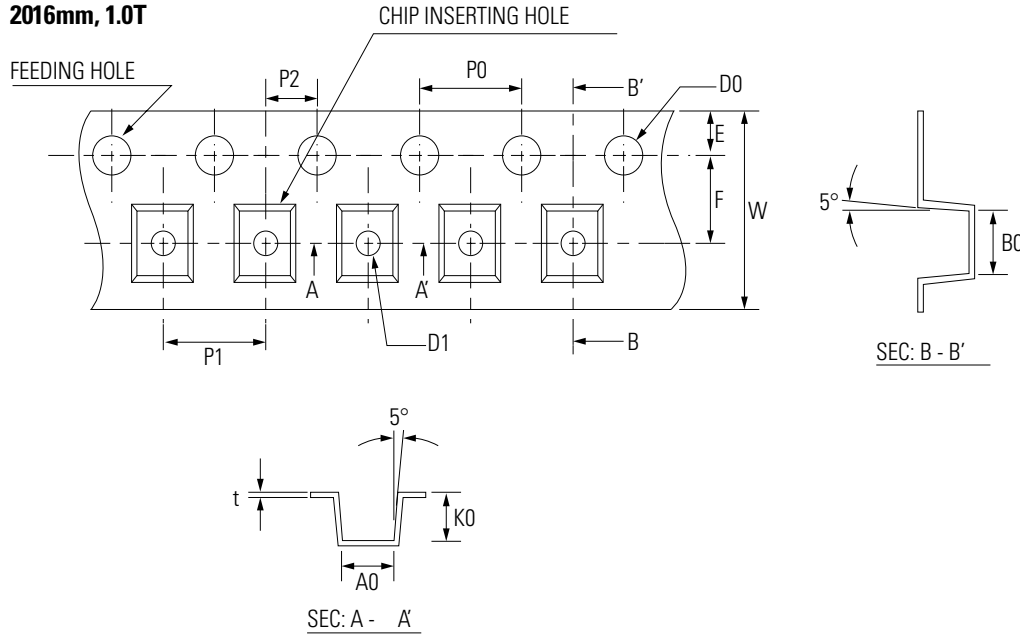

Symbol	Dimensions
	Milimeters
A0	1.90±0.10
B0	2.35±0.10
K0	1.15±0.10
W	8.00±0.2
F	3.50±0.05
E	1.75±0.10
P1	4.00±0.10
P2	2.00±0.05
P0	4.00±0.05
D0	1.50+0.10 & -0
D1	1.00±0.10
t	0.22±0.05

Tape and Reel Dimensions

2016mm, 1.0T

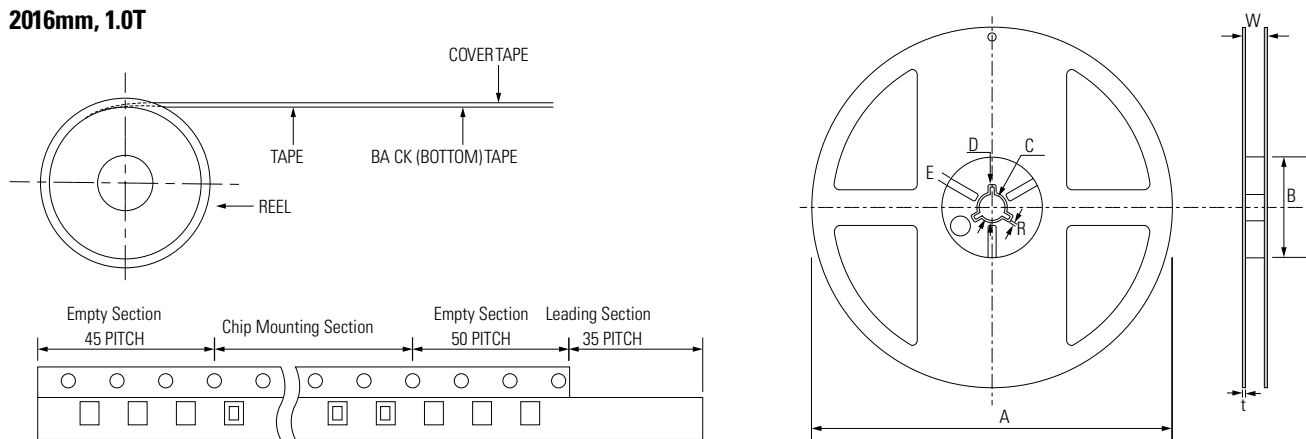

- (1) Reel Materials: Polystyrene (2) Label (3) Taping
- Standard Packing Quantity per Reel (Ø178)
- PE Tape: 3,000pcs

Code	A	B	C	D	E	W	t	R
Dimension	Ø178±2	Min. Ø50	Ø13±0.5	Ø21±0.8	2.0±0.5	10±1.5	0.8±0.2	1.0

LPWI Series

Surface Mount

Carrier Tape Dimensions

2520mm, 1.0T

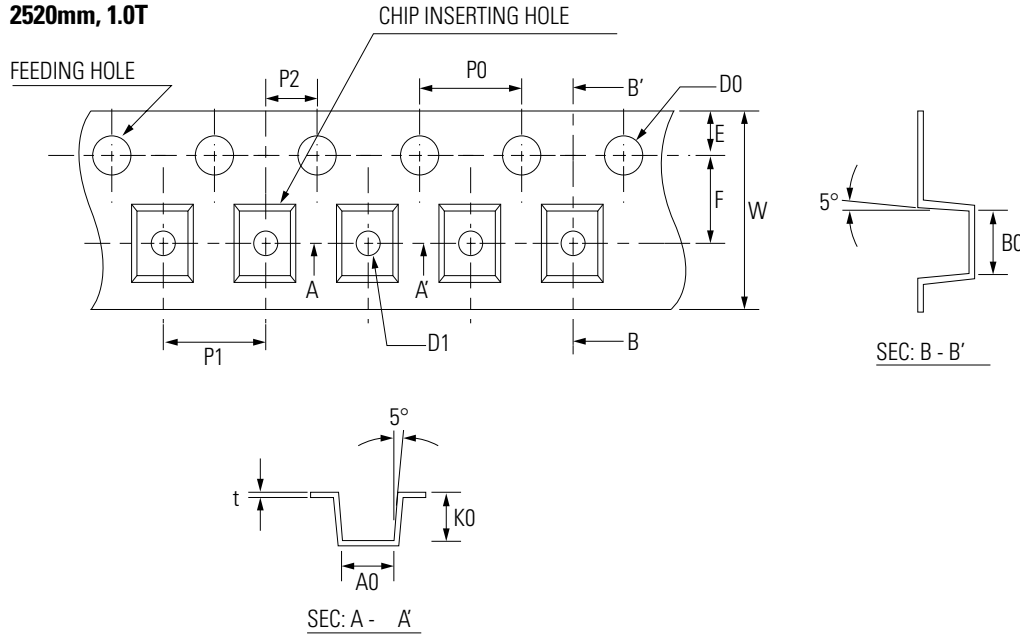

Symbol	Dimensions
	Milimeters
A0	2.23±0.10
B0	2.74±0.10
K0	1.17±0.10
W	8.00±0.2
F	3.50±0.05
E	1.75±0.10
P1	4.00±0.10
P2	2.00±0.05
P0	4.00±0.05
D0	1.50+0.10 & -0
D1	1.00±0.10
t	0.22±0.05

Tape and Reel Dimensions

2520mm, 1.0T

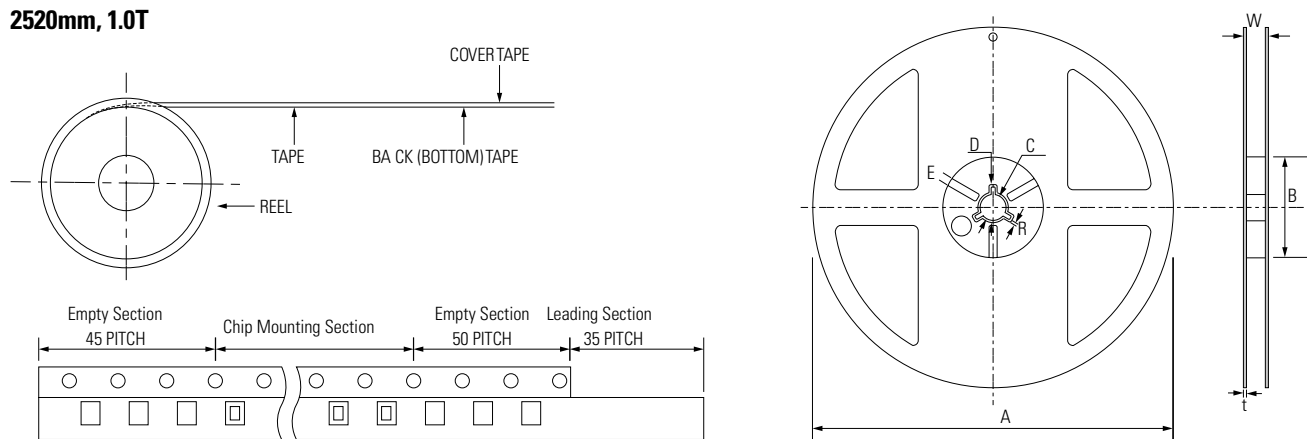

- (1) Reel Materials: Polystyrene (2) Label (3) Taping
- Standard Packing Quantity per Reel (Ø178)
- PE Tape: 3,000pcs

Code	A	B	C	D	E	W	t	R
Dimension	Ø178±2	Min. Ø50	Ø13±0.5	Ø20±0.8	3.0±0.5	10±1.5	1.3±0.2	1.0±0.2

LPWI Series

Surface Mount

Part Numbering System

LPWI 201608 S R47 T

Function

Power Inductor

Series and Dimensions

(L x W x T, mm)
2.00 x 1.60 x 0.80

Remark: Characterization Code

Inductance

@1MHz (uH)
R47= 0.47±20%

Tape and Reel

Packaging

Part Number	Packaging Option	Quantity
LPWI1608*****	Tape and Reel	4000
LPWI2012*****	Tape and Reel	3000
LPWI2016*****	Tape and Reel	3000
LPWI2520*****	Tape and Reel	3000

Disclaimer Notice - Information furnished is believed to be accurate and reliable. However, users should independently evaluate the suitability of and test each product selected for their own applications. Littelfuse products are not designed for, and may not be used in, all applications. Read complete Disclaimer Notice at www.littelfuse.com/disclaimer-electronics.