



Parameters	Ratings	Units
Blocking Voltage	600	V_P
Load Current	130	mA_{rms} / mA_{DC}
On-Resistance (max)	35	Ω

Features

- 5000V_{rms} Input/Output Isolation
- Low Drive Power Requirements
- Greater Reliability than Electromechanical Relays
- No EMI/RFI Generation
- Small 6-Pin Package
- Flammability Rating UL 94 V-0

Applications

- Sensor Circuitry
- Instrumentation
- Multiplexers
- Data Acquisition
- Electronic Switching
- I/O Subsystems
- Meters (Watt-Hour, Water, Gas)
- Medical Equipment: Patient/Equipment Isolation
- Industrial Controls

Description

The PLA194 is a single-pole, normally open (1-Form-A) solid state relay that uses optically coupled relay technology to provide an enhanced 5000V_{rms} isolation barrier between the input and the output of the relay.

Its optically coupled outputs, which use the patented OptoMOS architecture, are controlled by a highly efficient infrared LED.

Approvals

- UL Recognized Component: File E76270
- TUV EN 62368-1: Certificate # B 082667 0008

Ordering Information

Part #	Description
PLA194	6-Pin DIP (50/Tube)
PLA194S	6-Pin Surface Mount (50/Tube)
PLA194STR	6-Pin Surface Mount (1000/Reel)

Pin Configuration

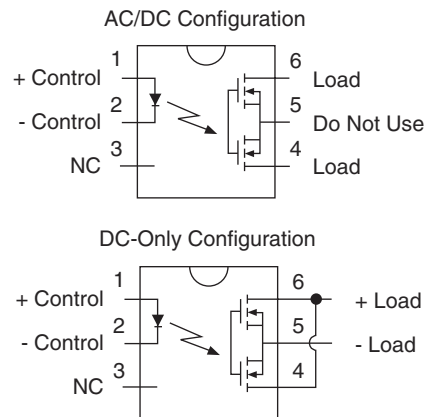

Switching Characteristics of Normally Open Devices

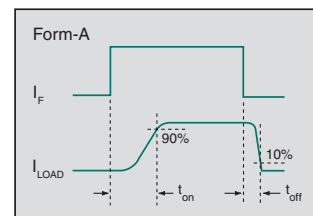

Absolute Maximum Ratings @ 25°C

Parameter	Min	Max	Units
Blocking Voltage	-	600	V _P
Reverse Input Voltage	-	5	V
Input Control Current	-	50	mA
Peak (10ms)	-	1	A
Input Power Dissipation ¹	-	150	mW
Total Package Dissipation ²	-	800	mW
ESD Rating, Human Body Model	8	-	kV
Isolation Voltage, Input to Output	5000	-	V _{rms}
Operational Temperature, Ambient	-40	85	°C
Storage Temperature	-40	125	°C

¹ Derate linearly 1.33 mW / °C

² Derate output power linearly 6.67 mW / °C

Absolute Maximum Ratings are stress ratings. Stresses in excess of these ratings can cause permanent damage to the device. Functional operation of the device at conditions beyond those indicated in the operational sections of this data sheet is not implied.

Typical values are characteristic of the device at +25°C, and are the result of engineering evaluations. They are provided for information purposes only, and are not part of the manufacturing testing requirements.

Electrical Characteristics @ 25°C

Parameters	Conditions	Symbol	Min	Typ	Max	Units
Output Characteristics						
Blocking Voltage	I _L =1μA	V _{DRM}	600	-	-	V _P
Load Current						
Continuous, AC/DC Configuration ¹	-	I _L	-	-	130	mA _{rms} / mA _{DC}
Continuous, DC-Only Configuration		I _L	-	-	200	mA _{DC}
Peak	t=10ms	I _{LPK}	-	-	±400	mA _P
On-Resistance ²						
AC/DC Configuration	I _L =130mA	R _{ON}	-	26	35	Ω
DC-Only Configuration	I _L =200mA		-	-	18	
Off-State Leakage Current	V _L =600V	I _{LEAK}	-	-	1	μA
Switching Speeds						
Turn-On	I _F =5mA, V _L =10V	t _{on}	-	0.85	3	ms
Turn-Off		t _{off}	-	0.46	2	
Output Capacitance	I _F =0mA, V _L =50V, f=1MHz	C _{OUT}	-	5	-	pF
Input Characteristics						
Input Control Current to Activate ³	I _L =130mA	I _F	-	0.44	2	mA
Input Control Current to Deactivate	-	I _F	0.1	-	-	mA
Input Voltage Drop	I _F =5mA	V _F	0.9	1.36	1.5	V
Reverse Input Current	V _R =5V	I _R	-	-	10	μA
Common Characteristics						
Input to Output Capacitance	V _{IO} =0V, f=1MHz	C _{IO}	-	3	-	pF

¹ Load current derates linearly from 130mA @ 25°C to 65mA @ 85°C.

² Measurement taken within 1 second of on-time.

³ For applications requiring high temperature operation (greater than 60°C), a minimum LED drive current of 3mA is recommended.

PERFORMANCE DATA*

Typical LED Forward Voltage Drop
(N=50, $I_F=5\text{mA}$)

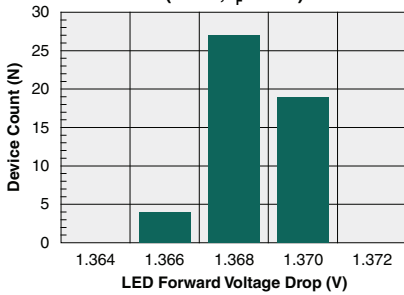

Typical Turn-On Time
(N=50, $I_F=5\text{mA}$, $I_L=130\text{mA}$)

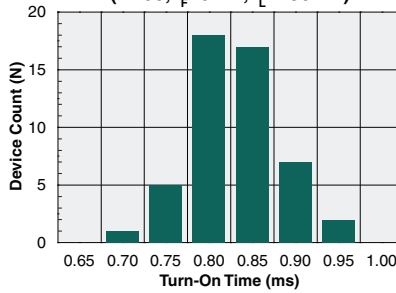

Typical Turn-Off Time
(N=50, $I_F=5\text{mA}$, $I_L=130\text{mA}$)

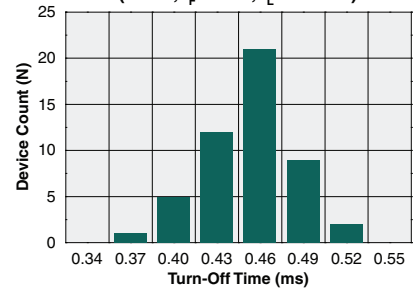

Typical I_F for Switch Operation
(N=50, $I_L=130\text{mA}$)

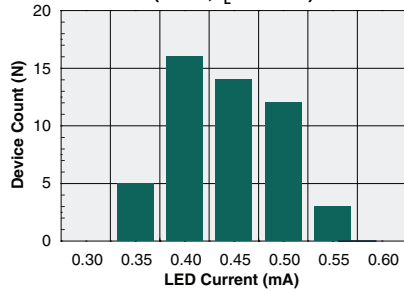

Typical On-Resistance Distribution
(N=50, $I_F=2\text{mA}$, $I_L=130\text{mA}$)

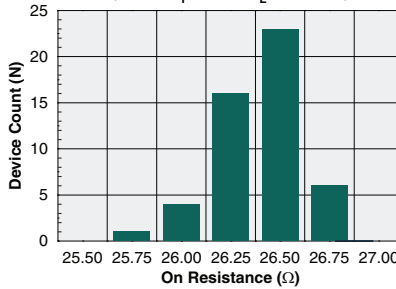

Typical Blocking Voltage Distribution
(N=50)

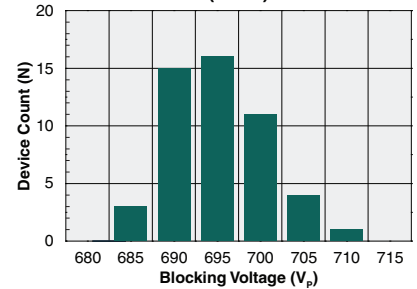

Typical LED Forward Voltage Drop vs. Temperature

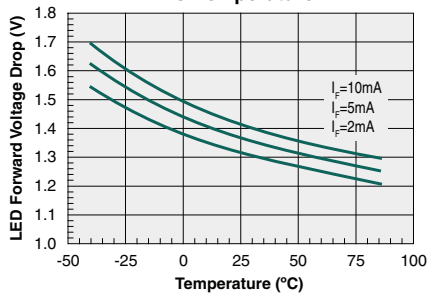

Typical Turn-On Time vs. LED Forward Current
($I_L=70\text{mA}$)

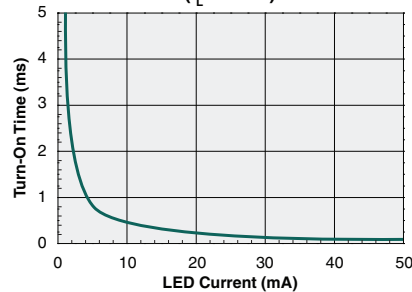

Typical Turn-Off Time vs. LED Forward Current
($I_L=70\text{mA}$)

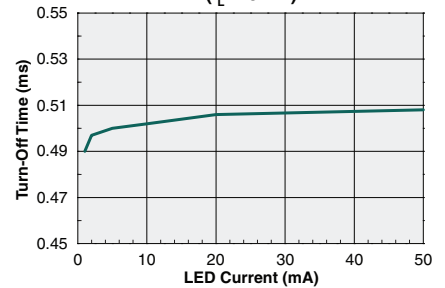

Typical I_F for Switch Operation vs. Temperature
($I_L=70\text{mA}$)

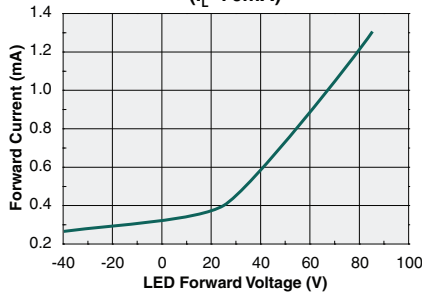

Typical Turn-On Time vs. Temperature
($I_L=70\text{mA}$)

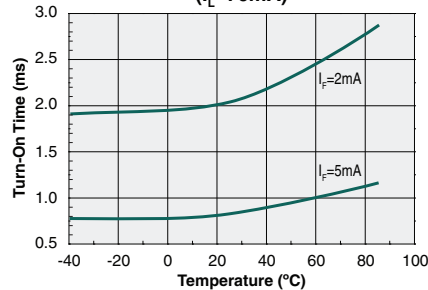

Typical Turn-Off Time vs. Temperature
($I_L=70\text{mA}$)

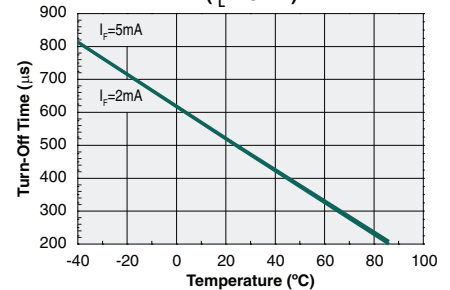

*Unless otherwise noted, data presented in these graphs is typical of device operation at 25°C.

PERFORMANCE DATA*

Typical On-Resistance vs. Temperature
($I_F=2\text{mA}$, $I_L=70\text{mA}$)

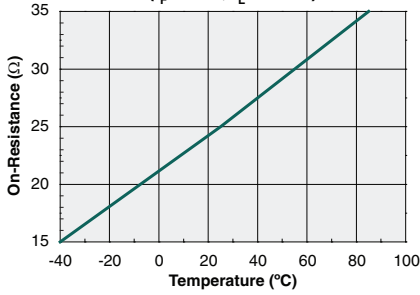

Maximum Load Current vs. Temperature
AC/DC Configuration
($I_F=2\text{mA}$)

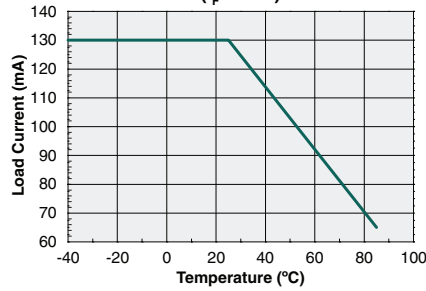

Maximum Load Current vs. Temperature
DC-Only Configuration
($I_F=2\text{mA}$)

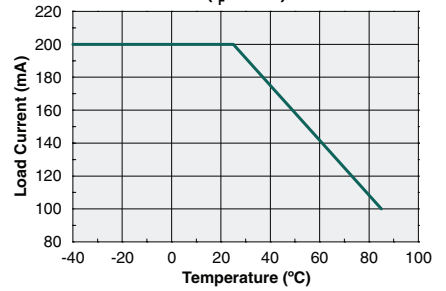

Typical Load Current vs. Load Voltage
($I_F=2\text{mA}$)

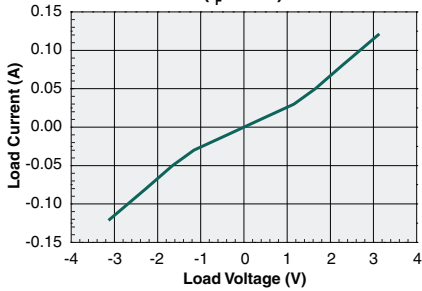

Typical Blocking Voltage
vs. Temperature

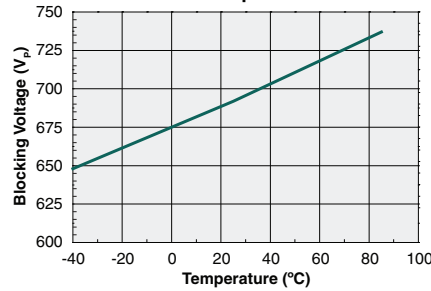

Typical Leakage vs. Temperature
($V_L=600\text{V}$)

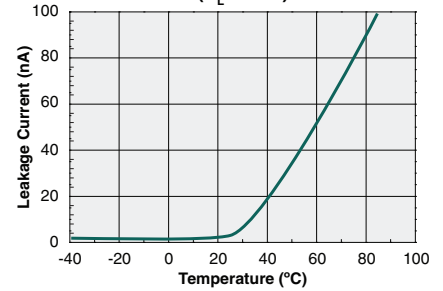

Output Capacitance vs. Load Voltage
($I_F=0\text{mA}$, $f=1\text{MHz}$)

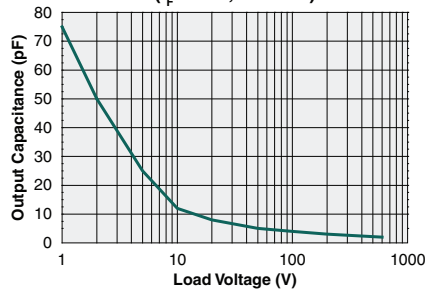

Energy Rating Curve

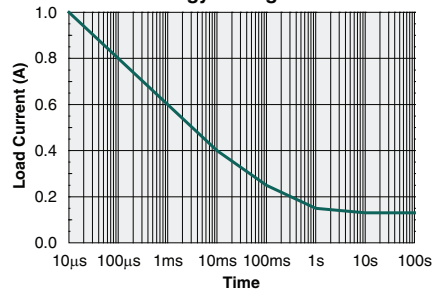

*Unless otherwise noted, data presented in these graphs is typical of device operation at 25°C.

Manufacturing Information

Moisture Sensitivity



All plastic encapsulated semiconductor packages are susceptible to moisture ingress. IXYS Integrated Circuits classifies its plastic encapsulated devices for moisture sensitivity according to the latest version of the joint industry standard, **IPC/JEDEC J-STD-020**, in force at the time of product evaluation. We test all of our products to the maximum conditions set forth in the standard, and guarantee proper operation of our devices when handled according to the limitations and information in that standard as well as to any limitations set forth in the information or standards referenced below.

Failure to adhere to the warnings or limitations as established by the listed specifications could result in reduced product performance, reduction of operable life, and/or reduction of overall reliability.

This product carries a **Moisture Sensitivity Level (MSL)** classification as shown below, and should be handled according to the requirements of the latest version of the joint industry standard **IPC/JEDEC J-STD-033**.

Device	Moisture Sensitivity Level (MSL) Classification
PLA194S	MSL 1

ESD Sensitivity



This product is ESD Sensitive, and should be handled according to the industry standard **JESD-625**.

Soldering Profile

Provided in the table below is the **IPC/JEDEC J-STD-020** Classification Temperature (T_C) and the maximum total dwell time (t_p) in all reflow processes that the body temperature of these surface mount devices may be ($T_C - 5$)°C or greater. The device's body temperature must not exceed the Classification Temperature at any time during reflow soldering processes.

Device	Classification Temperature (T_C)	Dwell Time (t_p)	Max Reflow Cycles
PLA194S	250°C	30 seconds	3

For through-hole devices, the maximum pin temperature and maximum dwell time through all solder waves is provided in the table below. Dwell time is the interval beginning when the pins are initially immersed into the solder wave until they exit the solder wave. For multiple waves, the dwell time is from entering the first wave until exiting the last wave. During this time, pin temperatures must not exceed the maximum temperature given in the table below. Body temperature of the device must not exceed the limit shown in the table below at any time during the soldering process.

Device	Maximum Pin Temperature	Maximum Body Temperature	Maximum Dwell Time	Wave Cycles
PLA194	260°C	250°C	10 seconds*	1

*Total cumulative duration of all waves.

Board Wash

IXYS Integrated Circuits recommends the use of no-clean flux formulations. Board washing to reduce or remove flux residue following the solder reflow process is acceptable provided proper precautions are taken to prevent damage to the device. These precautions include but are not limited to: using a low pressure wash and providing a follow up bake cycle sufficient to remove any moisture trapped within the device due to the washing process. Due to the variability of the wash parameters used to clean the board, determination of the bake temperature and duration necessary to remove the moisture trapped within the package is the responsibility of the user (assembler). Cleaning or drying methods that employ ultrasonic energy may damage the device and should not be used. Additionally, the device must not be exposed to halide flux or solvents.



Mechanical Dimensions

PLA194

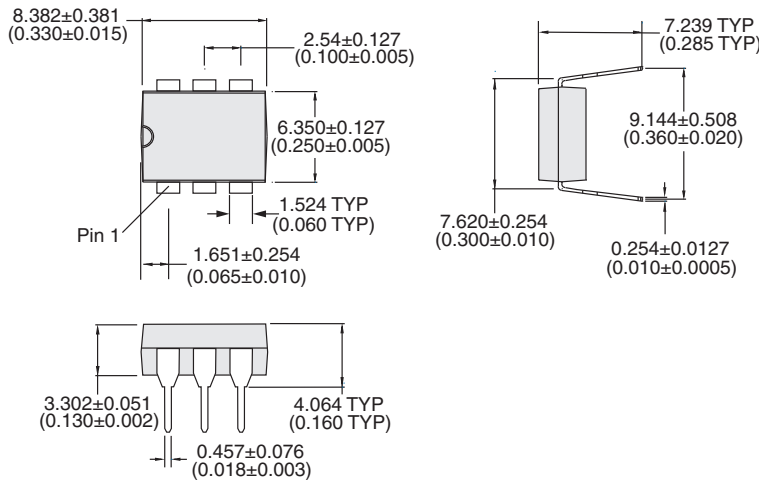

PCB Hole Pattern

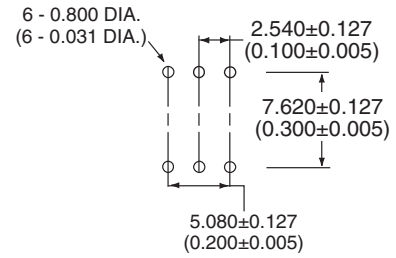

Controlling dimension: inches

Dimensions
mm
(inches)

PLA194S

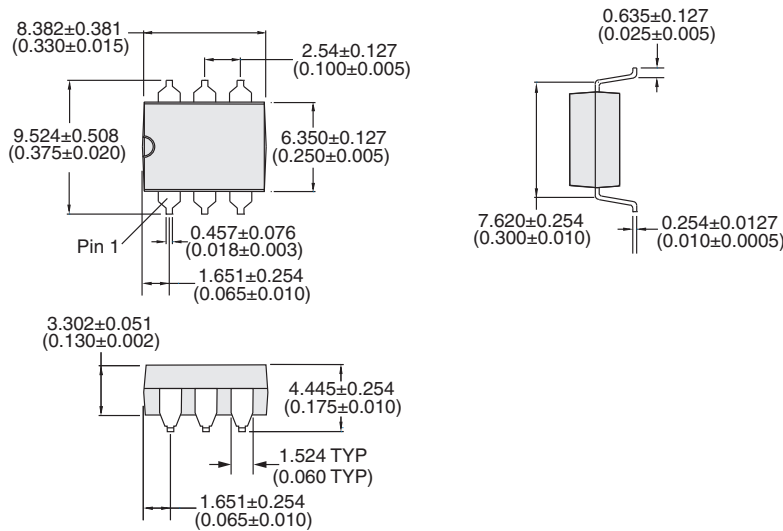

PCB Land Pattern

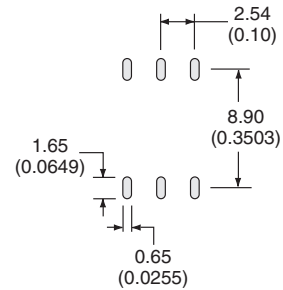

Controlling dimension: inches

Dimensions
mm
(inches)

PLA194STR Tape & Reel

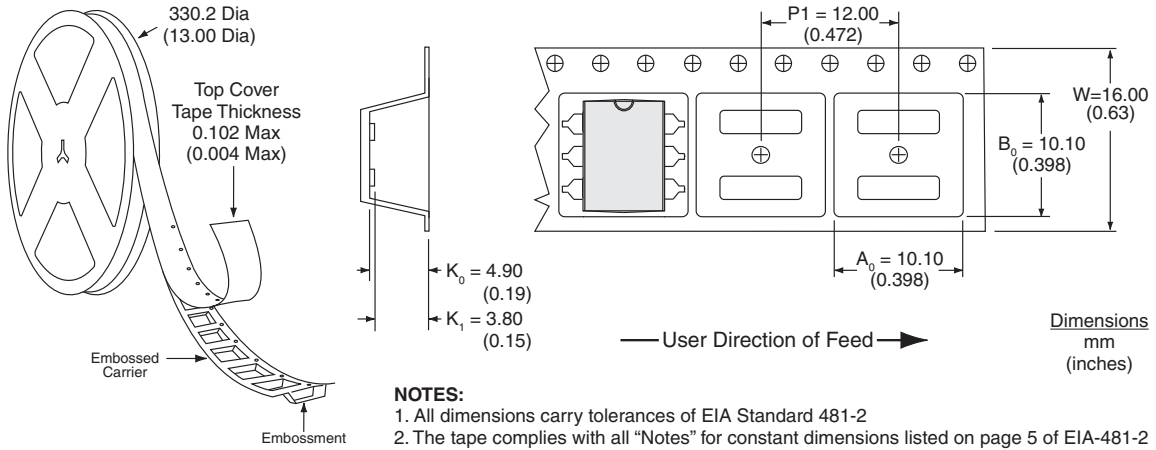

For additional information please visit our website at: <https://www.ixysic.com>