

HiPerFRED²

$$V_{RRM} = 400 \text{ V}$$

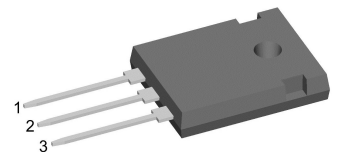
$$I_{FAV} = 2 \times 30 \text{ A}$$

$$t_{rr} = 45 \text{ ns}$$

High Performance Fast Recovery Diode
 Low Loss and Soft Recovery
 Common Cathode

Part number

DPG60C400HB



Backside: cathode



Features / Advantages:

- Planar passivated chips
- Very low leakage current
- Very short recovery time
- Improved thermal behaviour
- Very low I_{rm} -values
- Very soft recovery behaviour
- Avalanche voltage rated for reliable operation
- Soft reverse recovery for low EMI/RFI
- Low I_{rm} reduces:
 - Power dissipation within the diode
 - Turn-on loss in the commutating switch

Applications:

- Antiparallel diode for high frequency switching devices
- Antisaturation diode
- Snubber diode
- Free wheeling diode
- Rectifiers in switch mode power supplies (SMPS)
- Uninterruptible power supplies (UPS)

Package: TO-247

- Industry standard outline
- RoHS compliant
- Epoxy meets UL 94V-0

Disclaimer Notice

Information furnished is believed to be accurate and reliable. However, users should independently evaluate the suitability of and test each product selected for their own applications. Littelfuse products are not designed for, and may not be used in, all applications. Read complete Disclaimer Notice at www.littelfuse.com/disclaimer-electronics.

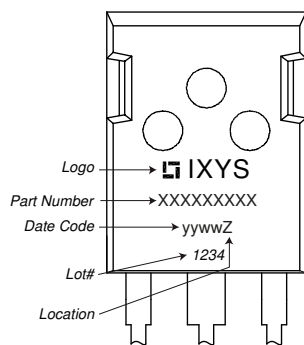


| Fast Diode | | | | Ratings | | | |
|------------|--|---|-------------------------|---------|------|------------|--|
| Symbol | Definition | Conditions | min. | typ. | max. | Unit | |
| V_{RSM} | max. non-repetitive reverse blocking voltage | $T_{VJ} = 25^{\circ}C$ | | | 400 | V | |
| V_{RRM} | max. repetitive reverse blocking voltage | $T_{VJ} = 25^{\circ}C$ | | | 400 | V | |
| I_R | reverse current, drain current | $V_R = 400 V$ | $T_{VJ} = 25^{\circ}C$ | | 1 | μA | |
| | | $V_R = 400 V$ | $T_{VJ} = 150^{\circ}C$ | | 0.2 | mA | |
| V_F | forward voltage drop | $I_F = 30 A$ | $T_{VJ} = 25^{\circ}C$ | | 1.41 | V | |
| | | $I_F = 60 A$ | | | 1.69 | V | |
| | | $I_F = 30 A$ | $T_{VJ} = 150^{\circ}C$ | | 1.13 | V | |
| | | $I_F = 60 A$ | | | 1.46 | V | |
| I_{FAV} | average forward current | $T_C = 135^{\circ}C$ rectangular $d = 0.5$ | $T_{VJ} = 175^{\circ}C$ | | 30 | A | |
| V_{FO} | threshold voltage | } for power loss calculation only | $T_{VJ} = 175^{\circ}C$ | | 0.76 | V | |
| r_F | slope resistance | | | | 10.7 | m Ω | |
| R_{thJC} | thermal resistance junction to case | | | | 0.95 | K/W | |
| R_{thCH} | thermal resistance case to heatsink | | | 0.3 | | K/W | |
| P_{tot} | total power dissipation | | $T_C = 25^{\circ}C$ | | 160 | W | |
| I_{FSM} | max. forward surge current | $t = 10 \text{ ms}; (50 \text{ Hz}), \text{ sine}; V_R = 0 \text{ V}$ | $T_{VJ} = 45^{\circ}C$ | | 360 | A | |
| C_J | junction capacitance | $V_R = 200 \text{ V}$ $f = 1 \text{ MHz}$ | $T_{VJ} = 25^{\circ}C$ | | 39 | pF | |
| I_{RM} | max. reverse recovery current | } $I_F = 30 \text{ A}; V_R = 270 \text{ V}$ $-di_F / dt = 200 \text{ A}/\mu\text{s}$ | $T_{VJ} = 25^{\circ}C$ | | 4 | A | |
| | | | $T_{VJ} = 125^{\circ}C$ | | 8.5 | A | |
| t_{rr} | reverse recovery time | | $T_{VJ} = 25^{\circ}C$ | | 45 | ns | |
| | | | $T_{VJ} = 125^{\circ}C$ | | 85 | ns | |



| Package TO-247 | | | Ratings | | | |
|----------------|------------------------------|----------------------------|---------|------|------|------|
| Symbol | Definition | Conditions | min. | typ. | max. | Unit |
| I_{RMS} | RMS current | per terminal ¹⁾ | | | 50 | A |
| T_{VJ} | virtual junction temperature | | -55 | | 175 | °C |
| T_{op} | operation temperature | | -55 | | 150 | °C |
| T_{stg} | storage temperature | | -55 | | 150 | °C |
| Weight | | | | 6 | | g |
| M_D | mounting torque | | 0.8 | | 1.2 | Nm |
| F_C | mounting force with clip | | 20 | | 120 | N |

Product Marking



Part description

- D = Diode
- P = HiPerFRED
- G = extreme fast
- 60 = Current Rating [A]
- C = Common Cathode
- 400 = Reverse Voltage [V]
- HB = TO-247AD (3)

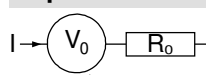
| Ordering | Ordering Number | Marking on Product | Delivery Mode | Quantity | Code No. |
|----------|-----------------|--------------------|---------------|----------|----------|
| Standard | DPG60C400HB | DPG60C400HB | Tube | 30 | 505825 |

| Similar Part | Package | Voltage class |
|--------------|--------------|---------------|
| DPG60C400QB | TO-3P (3) | 400 |
| DPG80C400HB | TO-247AD (3) | 400 |

Equivalent Circuits for Simulation

** on die level*

$T_{VJ} = 175^{\circ}C$



Fast Diode

| | | | |
|--------------|--------------------|------|----|
| $V_{0\ max}$ | threshold voltage | 0.76 | V |
| $R_{0\ max}$ | slope resistance * | 8.1 | mΩ |



Outlines TO-247



| Sym. | Inches | | Millimeter | |
|------|-----------|-------|------------|-------|
| | min. | max. | min. | max. |
| A | 0.185 | 0.209 | 4.70 | 5.30 |
| A1 | 0.087 | 0.102 | 2.21 | 2.59 |
| A2 | 0.059 | 0.098 | 1.50 | 2.49 |
| D | 0.819 | 0.845 | 20.79 | 21.45 |
| E | 0.610 | 0.640 | 15.48 | 16.24 |
| E2 | 0.170 | 0.216 | 4.31 | 5.48 |
| e | 0.215 BSC | | 5.46 BSC | |
| L | 0.780 | 0.800 | 19.80 | 20.30 |
| L1 | - | 0.177 | - | 4.49 |
| Ø P | 0.140 | 0.144 | 3.55 | 3.65 |
| Q | 0.212 | | 5.38 | |
| S | 0.242 BSC | | 6.14 BSC | |
| b | 0.039 | 0.055 | 0.99 | 1.40 |
| b2 | 0.065 | 0.094 | 1.65 | 2.39 |
| b4 | 0.102 | 0.135 | 2.59 | 3.43 |
| c | 0.015 | 0.035 | 0.38 | 0.89 |
| D1 | 0.515 | - | 13.07 | - |
| D2 | 0.020 | 0.053 | 0.51 | 1.35 |
| E1 | 0.530 | - | 13.45 | - |
| Ø P1 | - | 0.29 | - | 7.39 |



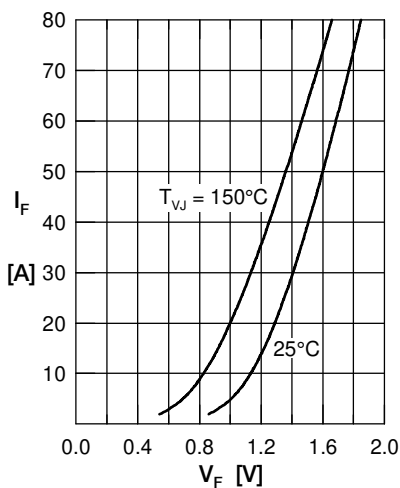
Fast Diode


Fig. 1 Forward current I_F versus V_F

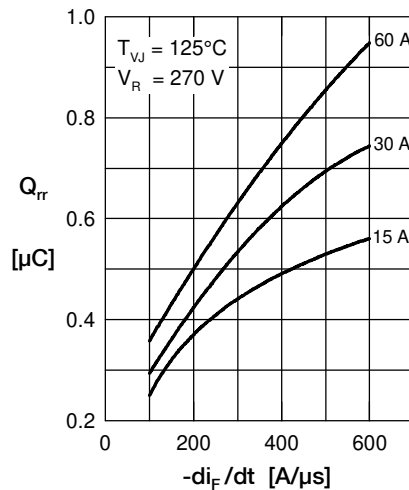


Fig. 2 Typ. reverse recov. charge Q_{rr} versus $-di_F/dt$

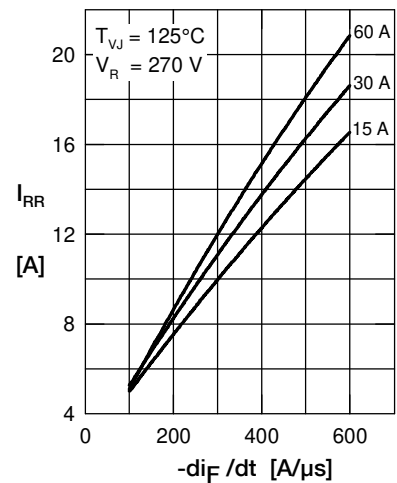


Fig. 3 Typ. reverse recovery current I_{RR} versus $-di_F/dt$

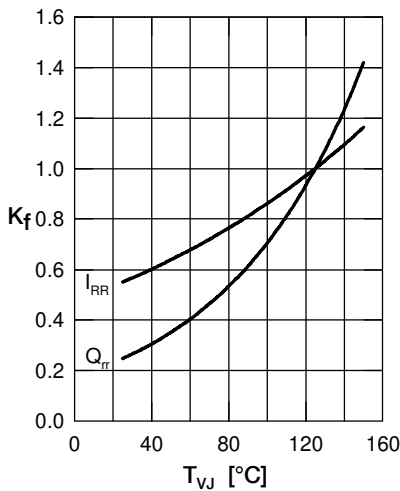


Fig. 4 Typ. dynamic parameters Q_{rr} , I_{RR} versus T_{VJ}

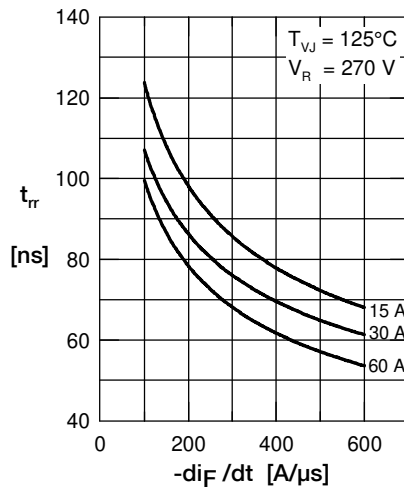


Fig. 5 Typ. reverse recov. time t_{rr} versus $-di_F/dt$

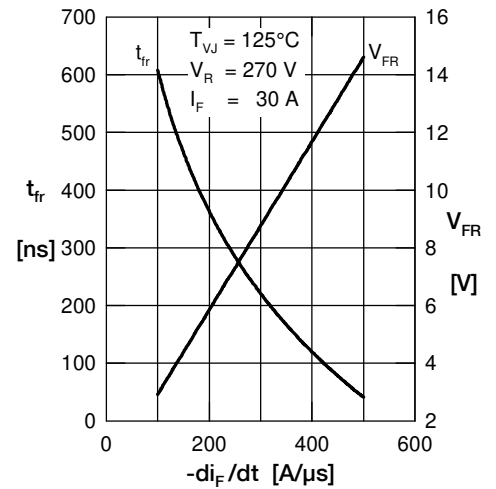


Fig. 6 Typ. forward recov. voltage V_{FR} & time t_{fr} versus di_F/dt

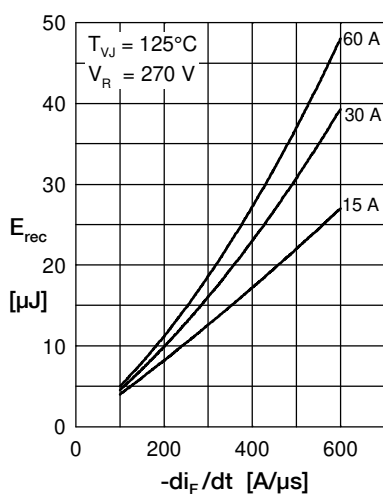


Fig. 7 Typ. recovery energy E_{rec} versus $-di_F/dt$

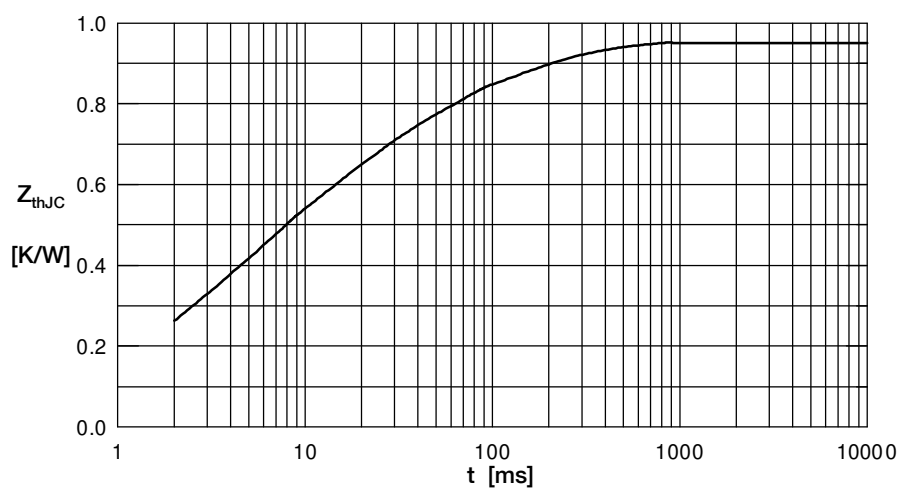


Fig. 8 Transient thermal impedance junction to case