

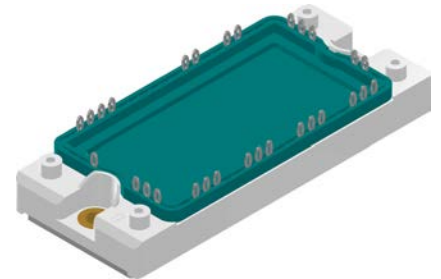
Standard Rectifier Module

3~ Rectifier	Brake Chopper
$V_{RRM} = 1600\text{ V}$	$V_{CES} = 1200\text{ V}$
$I_{DAV} = 280\text{ A}$	$I_{C25} = 180\text{ A}$
$I_{FSM} = 1500\text{ A}$	$V_{CE(sat)} = 1,7\text{ V}$


3~ Rectifier Bridge + Brake Unit + NTC

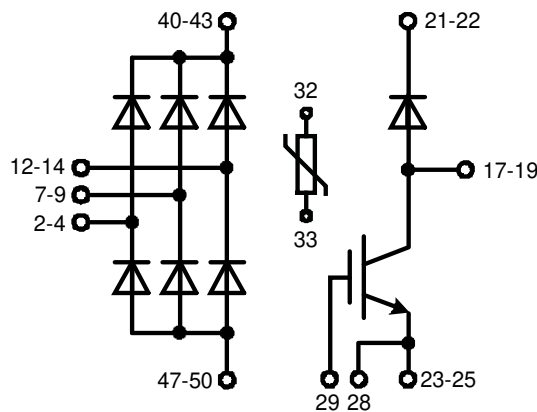
Part number

MDMA280UB1600PTED



Backside: isolated

 E72873



Features / Advantages:

- Package with DCB ceramic
- Improved temperature and power cycling
- Planar passivated chips
- Very low forward voltage drop
- Very low leakage current
- NTC
- X2PT - 2nd generation Xtreme light Punch Through
- Rugged X2PT design results in:
 - short circuit rated for 10 μsec .
 - very low gate charge
 - low EMI
 - square RBSOA @ 2x I_c
- Thin wafer technology combined with X2PT design results in a competitive low $V_{CE(sat)}$ and low thermal resistance

Applications:

- 3~ Rectifier with brake unit for drive inverters

Package: E2-Pack

- Isolation Voltage: 4300 V~
- Industry standard outline
- RoHS compliant
- PressFit-Pins for PCB mounting
- Height: 17 mm
- Base plate: Copper internally DCB isolated
- Advanced power cycling
- Phase Change Material available

Disclaimer Notice

Information furnished is believed to be accurate and reliable. However, users should independently evaluate the suitability of and test each product selected for their own applications. Littelfuse products are not designed for, and may not be used in, all applications. Read complete Disclaimer Notice at www.littelfuse.com/disclaimer-electronics.



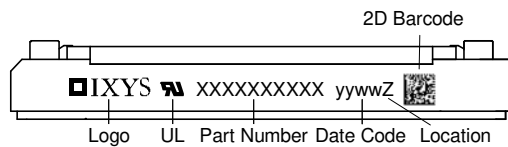
Rectifier				Ratings			
Symbol	Definition	Conditions		min.	typ.	max.	Unit
V_{RSM}	max. non-repetitive reverse blocking voltage					1700	V
V_{RRM}	max. repetitive reverse blocking voltage					1600	V
I_R	reverse current	$V_R = 1600$ V		$T_{VJ} = 25^\circ\text{C}$		100	μA
		$V_R = 1600$ V		$T_{VJ} = 150^\circ\text{C}$		2	mA
V_F	forward voltage drop	$I_F = 90$ A		$T_{VJ} = 25^\circ\text{C}$		1,23	V
		$I_F = 270$ A				1,75	V
		$I_F = 90$ A		$T_{VJ} = 125^\circ\text{C}$		1,18	V
		$I_F = 270$ A				1,87	V
I_{DAV}	bridge output current	$T_C = 85^\circ\text{C}$	rectangular	$T_{VJ} = 150^\circ\text{C}$		280	A
			$d = \frac{1}{3}$				
V_{FO}	threshold voltage			$T_{VJ} = 150^\circ\text{C}$		0,80	V
r_F	slope resistance					4,1	m Ω
						} for power loss calculation only	
R_{thJC}	thermal resistance junction to case					0,35	K/W
R_{thCH}	thermal resistance case to heatsink				0,1		K/W
P_{tot}	total power dissipation			$T_C = 25^\circ\text{C}$		355	W
I_{FSM}	max. forward surge current	$t = 10$ ms; (50 Hz), sine		$T_{VJ} = 45^\circ\text{C}$		1,50	kA
		$t = 8,3$ ms; (60 Hz), sine		$V_R = 0$ V		1,62	kA
		$t = 10$ ms; (50 Hz), sine		$T_{VJ} = 150^\circ\text{C}$		1,28	kA
		$t = 8,3$ ms; (60 Hz), sine		$V_R = 0$ V		1,38	kA
I^2t	value for fusing	$t = 10$ ms; (50 Hz), sine		$T_{VJ} = 45^\circ\text{C}$		11,3	kA ² s
		$t = 8,3$ ms; (60 Hz), sine		$V_R = 0$ V		10,9	kA ² s
		$t = 10$ ms; (50 Hz), sine		$T_{VJ} = 150^\circ\text{C}$		8,13	kA ² s
		$t = 8,3$ ms; (60 Hz), sine		$V_R = 0$ V		7,87	kA ² s
C_J	junction capacitance	$V_R = 400$ V; $f = 1$ MHz		$T_{VJ} = 25^\circ\text{C}$		53	pF

Brake IGBT + Diode				Ratings					
Symbol	Definition	Conditions	min.	typ.	max.	Unit			
V_{CES}	collector emitter voltage	$T_{VJ} = 25^{\circ}C$			1200	V			
V_{GES}	max. DC gate voltage				± 20	V			
V_{GEM}	max. transient gate emitter voltage				± 30	V			
I_{C25}	collector current	$T_C = 25^{\circ}C$			180	A			
I_{C100}		$T_C = 100^{\circ}C$			140	A			
P_{tot}	total power dissipation	$T_C = 25^{\circ}C$			500	W			
$V_{CE(sat)}$	collector emitter saturation voltage	$I_C = 100\text{ A}; V_{GE} = 15\text{ V}$			1,7	V			
					1,9	V			
$V_{GE(th)}$	gate emitter threshold voltage	$I_C = 4\text{ mA}; V_{GE} = V_{CE}$	6	6,8	7,5	V			
I_{CES}	collector emitter leakage current	$V_{CE} = V_{CES}; V_{GE} = 0\text{ V}$			0,1	mA			
					0,1	mA			
I_{GES}	gate emitter leakage current	$V_{GE} = \pm 20\text{ V}$			500	nA			
$Q_{G(on)}$	total gate charge	$V_{CE} = 600\text{ V}; V_{GE} = 15\text{ V}; I_C = 100\text{ A}$		340		nC			
$t_{d(on)}$	turn-on delay time	inductive load $V_{CE} = 600\text{ V}; I_C = 100\text{ A}$ $V_{GE} = \pm 15\text{ V}; R_G = 6,8\ \Omega$							
t_r	current rise time						$T_{VJ} = 125^{\circ}C$	230	ns
$t_{d(off)}$	turn-off delay time						70	ns	
t_f	current fall time						380	ns	
E_{on}	turn-on energy per pulse						230	mJ	
E_{off}	turn-off energy per pulse						12,5	mJ	
					11,5	mJ			
RBSOA	reverse bias safe operating area	$V_{GE} = \pm 15\text{ V}; R_G = 6,8\ \Omega$							
I_{CM}		$V_{CEK} = 1200\text{ V}; \text{note } ^1)$			300	A			
SCSOA	short circuit safe operating area	$V_{CEK} = 1200\text{ V}$							
t_{SC}	short circuit duration	$V_{CE} = 720\text{ V}; V_{GE} = \pm 15$			10	μs			
I_{SC}	short circuit current	$R_G = 6,8\ \Omega; \text{non-repetitive}$		450		A			
R_{thJC}	thermal resistance junction to case				0,25	K/W			
R_{thCH}	thermal resistance case to heatsink				0,10	K/W			
Brake Diode									
V_{RRM}	max. repetitive reverse voltage	$T_{VJ} = 25^{\circ}C$			1200	V			
I_{F25}	forward current	$T_C = 25^{\circ}C$			88	A			
I_{F100}		$T_C = 100^{\circ}C$			59	A			
V_F	forward voltage	$I_F = 60\text{ A}$			2,20	V			
					1,95	V			
I_R	reverse current	$V_R = V_{RRM}$			0,1	mA			
					1,2	mA			
Q_{rr}	reverse recovery charge	$V_R = 600\text{ V}$ $-di_F/dt = 1200\text{ A}/\mu s$ $I_F = 60\text{ A}; V_{GE} = 0\text{ V}$							
I_{RM}	max. reverse recovery current						$T_{VJ} = 125^{\circ}C$	8	μC
t_{rr}	reverse recovery time						60	A	
E_{rec}	reverse recovery energy						350	ns	
					2,5	mJ			
R_{thJC}	thermal resistance junction to case				0,6	K/W			
R_{thCH}	thermal resistance case to heatsink				0,1	K/W			

¹⁾ RBSOA line test conditions for dynamic testing prior to static testing:

470A @ 820V and $T_C = 150^{\circ}C$ with gate drive +16.5V / -15V, $R_{G(on)} = 6.8\ \Omega$ and $R_{G(off)} = 43\ \Omega$.

Package E2-Pack		Ratings				
Symbol	Definition	Conditions	min.	typ.	max.	Unit
I_{RMS}	RMS current	per terminal			30	A
T_{VJ}	virtual junction temperature		-40		150	°C
T_{op}	operation temperature		-40		125	°C
T_{stg}	storage temperature		-40		125	°C
Weight				176		g
M_D	mounting torque		3		6	Nm
$d_{Spp/App}$	creepage distance on surface striking distance through air	terminal to terminal	6,0			mm
$d_{Spb/Apb}$		terminal to backside	12,0			mm
V_{ISOL}	isolation voltage	t = 1 second t = 1 minute	4300			V
		50/60 Hz, RMS; $I_{ISOL} \leq 1$ mA	3600			V


Part description

M = Module
 D = Diode
 M = Standard Rectifier
 A = (up to 1800V)
 280 = Current Rating [A]
 UB = 3- Rectifier Bridge + Brake Unit
 1600 = Reverse Voltage [V]
 PT = PressFit-Pin, Thermistor
 ED = E2-Pack
 - = Hyphen
 PC = Phase Change Material

Ordering	Ordering Number	Marking on Product	Delivery Mode	Quantity	Code No.
Standard	MDMA280UB1600PTED	MDMA280UB1600PTED	Blister	28	516613
Alternative	MDMA280UB1600PTED-PC	MDMA280UB1600PTED	Blister	28	515416

Temperature Sensor NTC

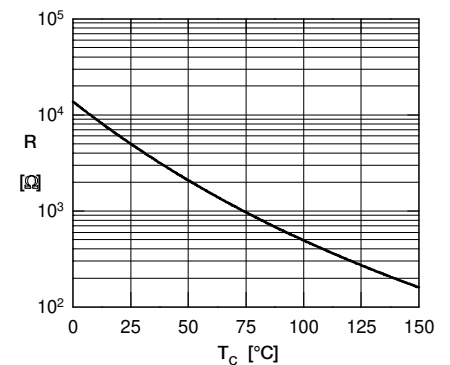
Symbol	Definition	Conditions	min.	typ.	max.	Unit
R_{25}	resistance	$T_{VJ} = 25^\circ$	4,85	5	5,15	k Ω
$B_{25/50}$	temperature coefficient			3375		K

Equivalent Circuits for Simulation

* on die level

 $T_{VJ} = 150^\circ\text{C}$

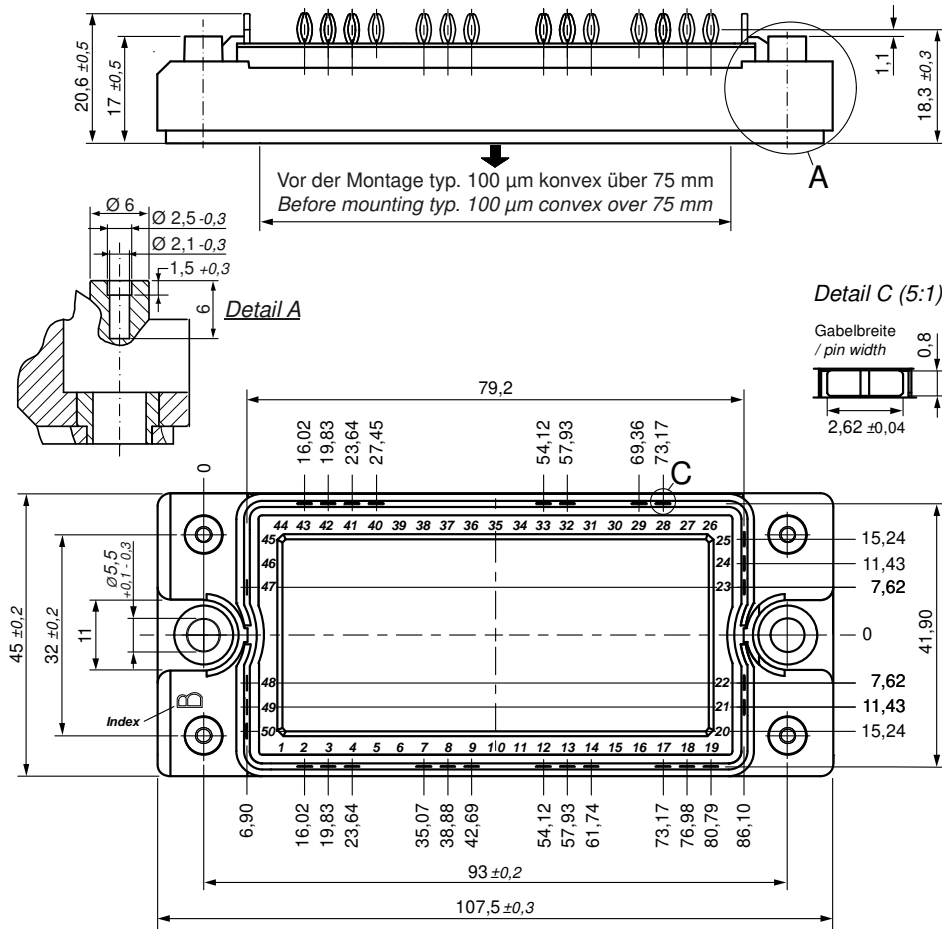
	Rectifier	Brake Diode	
V_0	0,8	1,22	V
R_0	2	13	m Ω



Typ. NTC resistance vs. temperature



Outlines E2-Pack

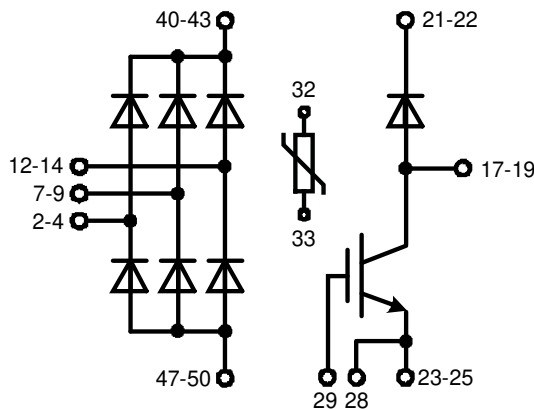


Bemerkung / Note:

- Nicht tolerierte Maße nach / Measure without tolerances according DIN ISO 2768-T1-m
- PCB-Lochmuster / PCB hole pattern: **see pin position**
- Toleranz Pin-Position und PCB-Lochmuster / Tolerance of pin position and PCB hole pattern: $\oplus 0,1$
- Bohrlochdurchmesser / Diameter of drill: **Ø 2.35 mm**
- Endlochdurchmesser / Diameter of plated holes: **Ø 2.14 - 2.29 mm** (Cu thickness in via typ. 50 µm)
- Beschichtung / Plating: **chem. Sn max. 15 µm**
- Einpresskraft / Insert Force: per terminal with a typ. insert speed of 7 mm/s: **typ. 90 N**
- Weitere Angaben / Further information: www.ixys.com **Application note IXAN0077**
- Montageanleitung / Mounting instruction: www.ixys.com **Application note IXAN0024**

Detail A: PCB-Montage / Mounting on PCB-

- Empfohlene, selbstschneidende Schraube / Recommended, self-tapping screw: **EJOT PT®** (Größe / size: **K25**)
- Max. Schraubenlänge / Max. screw length: **PCB-Dicke / thickness + 6 mm** (max. Lochtiefe / hole depth)
- Empfohlenes Drehmoment / Recommended mounting torque: **1.5 Nm**



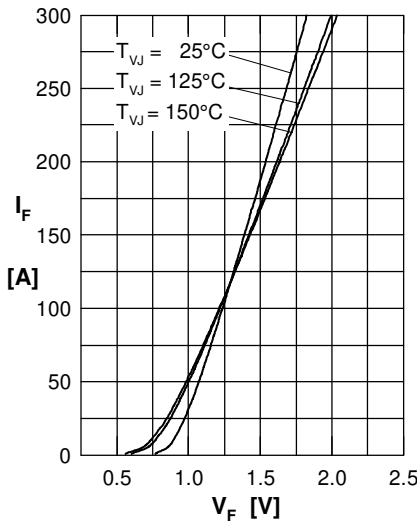
Rectifier


Fig. 1 Forward current versus voltage drop per diode

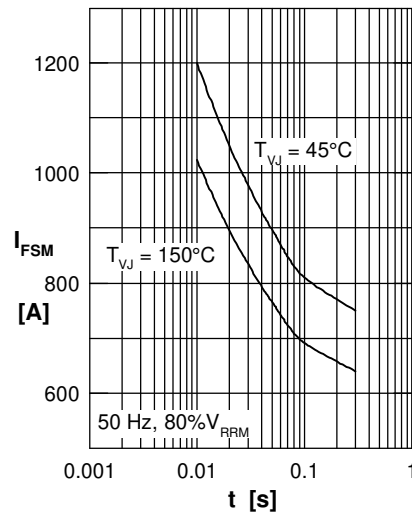


Fig. 2 Surge overload current vs. time per diode

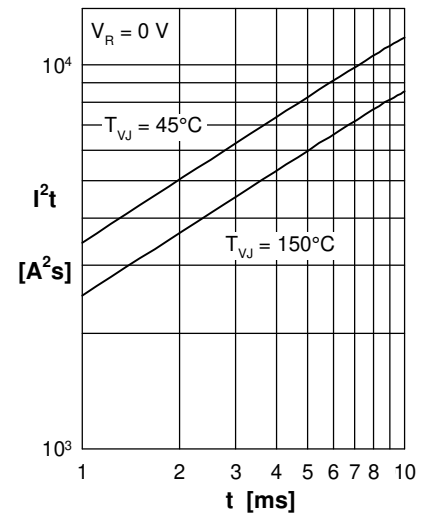
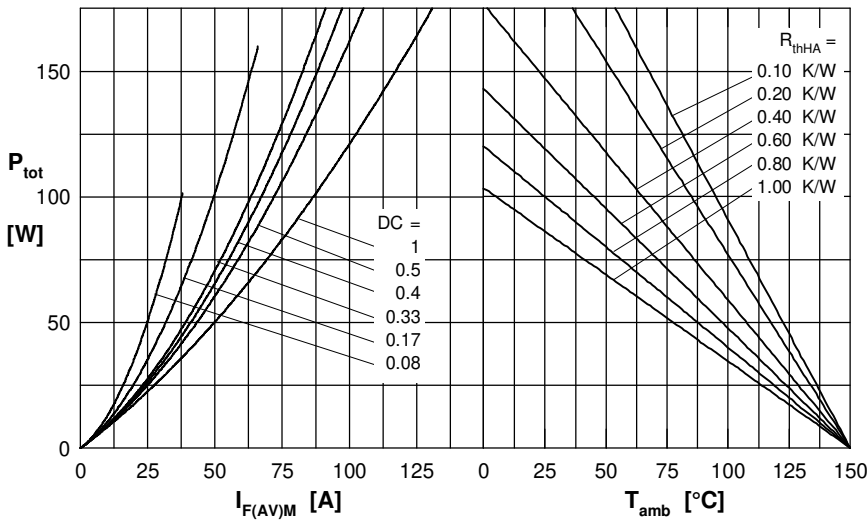

 Fig. 3 I^2t versus time per diode


Fig. 4 Power dissipation vs. forward current and ambient temperature per diode

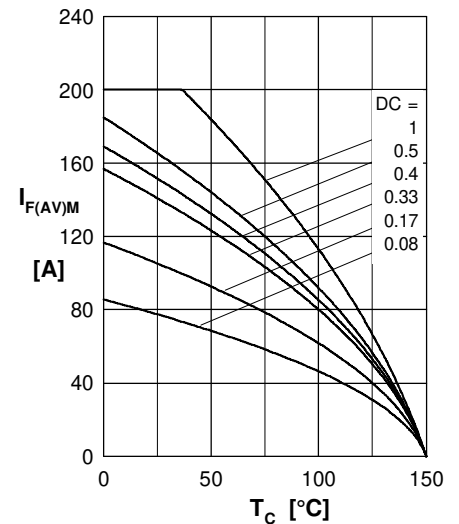


Fig. 5 Max. forward current vs. case temperature per diode

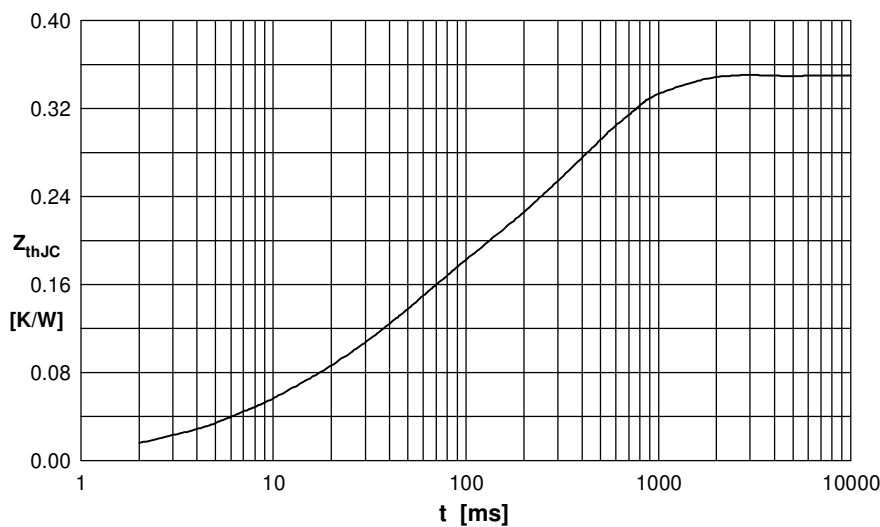


Fig. 6 Transient thermal impedance junction to case vs. time per diode

 Constants for Z_{thJC} calculation:

i	R_{thi} (K/W)	t_i (s)
1	0.030	0.006
2	0.003	0.007
3	0.114	0.040
4	0.203	0.400

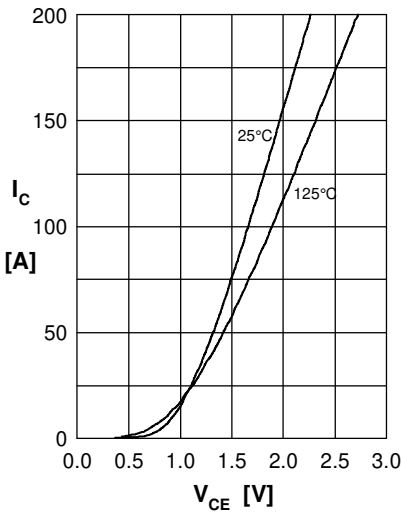
Brake IGBT + Diode


Fig.1 Output characteristics IGBT

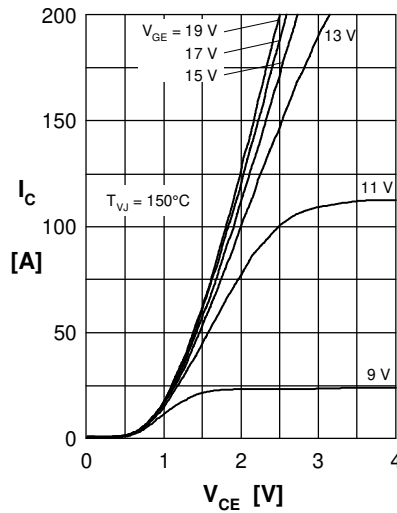


Fig.2 Typ. output characteristics IGBT

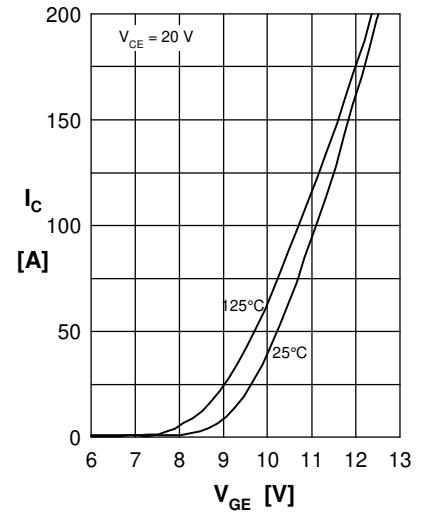


Fig.3 Typ. transfer charact. IGBT

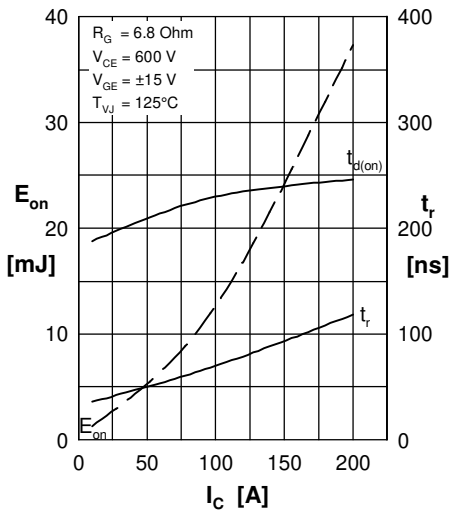


Fig.4 Typ. turn-on energy & switch. times vs. collector current

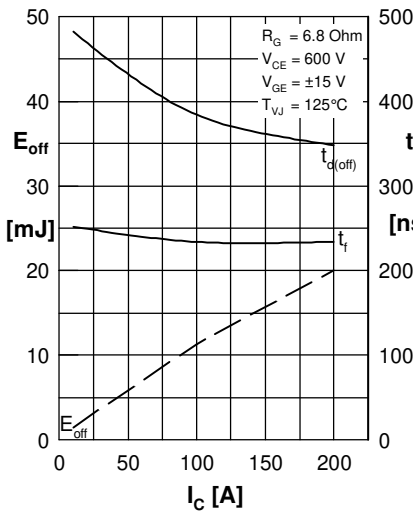


Fig.5 Typ. turn-off energy & switch. times vs. collector current

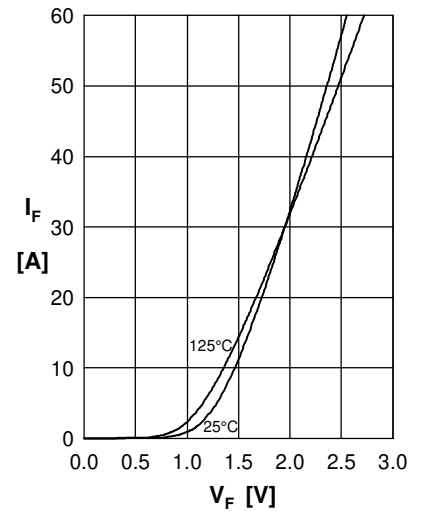
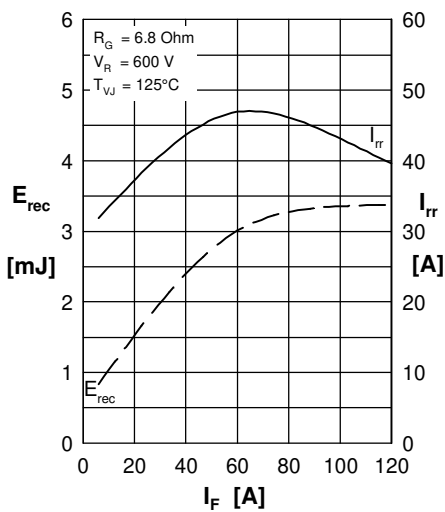

 Fig.6 Typ. forward current versus V_F


Fig.7 Typ. reverse recovery characteristics Diode

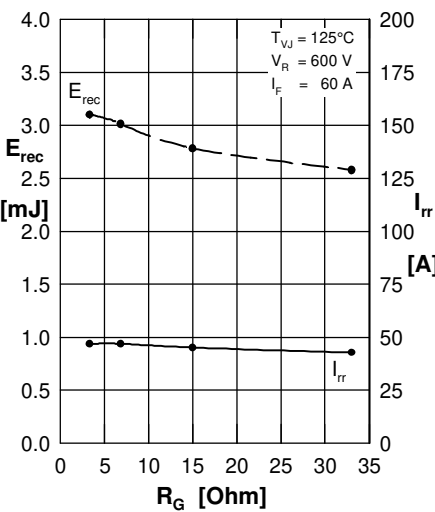


Fig.8 Typ. reverse recovery characteristics Diode

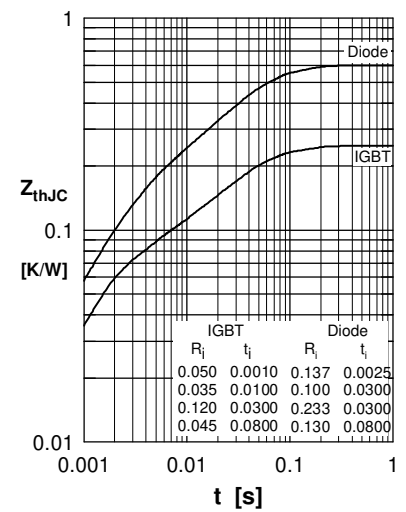


Fig.9 Transient thermal resistance junction to case