

Standard Rectifier Module

3~ Rectifier
$V_{RRM} = 1200\text{ V}$
$I_{DAV} = 125\text{ A}$
$I_{FSM} = 1200\text{ A}$

3~ Rectifier Bridge

Part number

VUO110-12N07

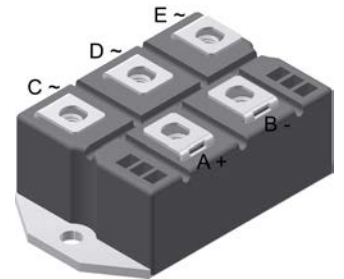

 E72873

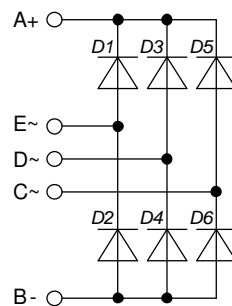

Features / Advantages:

- Package with DCB ceramic
- Improved temperature and power cycling
- Planar passivated chips
- Very low forward voltage drop
- Very low leakage current

Applications:

- Diode for main rectification
- For three phase bridge configurations
- Supplies for DC power equipment
- Input rectifiers for PWM inverter
- Battery DC power supplies
- Field supply for DC motors

Package: PWS-E

- Isolation Voltage: 3000 V~
- Industry standard outline
- RoHS compliant
- Easy to mount with two screws
- Base plate: Copper internally DCB isolated
- Advanced power cycling

Disclaimer Notice

Information furnished is believed to be accurate and reliable. However, users should independently evaluate the suitability of and test each product selected for their own applications. Littelfuse products are not designed for, and may not be used in, all applications. Read complete Disclaimer Notice at www.littelfuse.com/disclaimer-electronics.



Rectifier				Ratings			
Symbol	Definition	Conditions		min.	typ.	max.	Unit
V_{RSM}	max. non-repetitive reverse blocking voltage					1300	V
V_{RRM}	max. repetitive reverse blocking voltage					1200	V
I_R	reverse current	$V_R = 1200\text{ V}$		$T_{VJ} = 25^\circ\text{C}$		100	μA
		$V_R = 1200\text{ V}$		$T_{VJ} = 150^\circ\text{C}$		2	mA
V_F	forward voltage drop	$I_F = 50\text{ A}$		$T_{VJ} = 25^\circ\text{C}$		1,13	V
		$I_F = 150\text{ A}$				1,46	V
		$I_F = 50\text{ A}$		$T_{VJ} = 125^\circ\text{C}$		1,04	V
		$I_F = 150\text{ A}$				1,47	V
I_{DAV}	bridge output current	$T_C = 110^\circ\text{C}$		$T_{VJ} = 150^\circ\text{C}$		125	A
		rectangular	$d = \frac{1}{3}$				
V_{FO}	threshold voltage			$T_{VJ} = 150^\circ\text{C}$		0,79	V
r_F	slope resistance					4,5	m Ω
						} for power loss calculation only	
R_{thJC}	thermal resistance junction to case					0,7	K/W
R_{thCH}	thermal resistance case to heatsink				0,3		K/W
P_{tot}	total power dissipation			$T_C = 25^\circ\text{C}$		175	W
I_{FSM}	max. forward surge current	$t = 10\text{ ms}; (50\text{ Hz}), \text{ sine}$		$T_{VJ} = 45^\circ\text{C}$		1,20	kA
		$t = 8,3\text{ ms}; (60\text{ Hz}), \text{ sine}$		$V_R = 0\text{ V}$		1,30	kA
		$t = 10\text{ ms}; (50\text{ Hz}), \text{ sine}$		$T_{VJ} = 150^\circ\text{C}$		1,02	kA
		$t = 8,3\text{ ms}; (60\text{ Hz}), \text{ sine}$		$V_R = 0\text{ V}$		1,10	kA
I^2t	value for fusing	$t = 10\text{ ms}; (50\text{ Hz}), \text{ sine}$		$T_{VJ} = 45^\circ\text{C}$		7,20	kA ² s
		$t = 8,3\text{ ms}; (60\text{ Hz}), \text{ sine}$		$V_R = 0\text{ V}$		6,98	kA ² s
		$t = 10\text{ ms}; (50\text{ Hz}), \text{ sine}$		$T_{VJ} = 150^\circ\text{C}$		5,20	kA ² s
		$t = 8,3\text{ ms}; (60\text{ Hz}), \text{ sine}$		$V_R = 0\text{ V}$		5,04	kA ² s
C_J	junction capacitance	$V_R = 400\text{ V}; f = 1\text{ MHz}$		$T_{VJ} = 25^\circ\text{C}$		37	pF



Package PWS-E				Ratings			
Symbol	Definition	Conditions	min.	typ.	max.	Unit	
I_{RMS}	RMS current	per terminal			200	A	
T_{VJ}	virtual junction temperature		-40		150	°C	
T_{op}	operation temperature		-40		125	°C	
T_{stg}	storage temperature		-40		125	°C	
Weight					284	g	
M_D	mounting torque		4,25		5,75	Nm	
M_T	terminal torque		4,25		5,75	Nm	
$d_{Spp/App}$	creepage distance on surface striking distance through air	terminal to terminal	12,0			mm	
$d_{Spb/Apb}$		terminal to backside	26,0			mm	
V_{ISOL}	isolation voltage	t = 1 second	3000			V	
		t = 1 minute	2500			V	

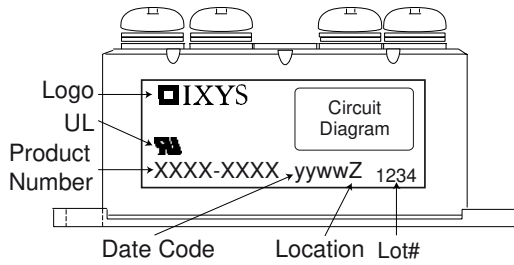

Ordering	Ordering Number	Marking on Product	Delivery Mode	Quantity	Code No.
Standard	VUO110-12NO7	VUO110-12NO7	Box	5	462373

Equivalent Circuits for Simulation

* on die level

$T_{VJ} = 150^{\circ}C$

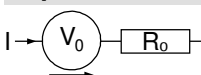

Rectifier

$V_{0\ max}$	threshold voltage	0,79	V
$R_{0\ max}$	slope resistance *	3,3	mΩ



Outlines PWS-E

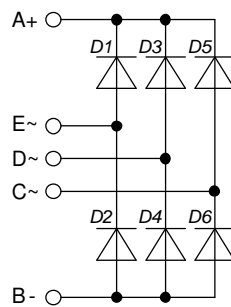
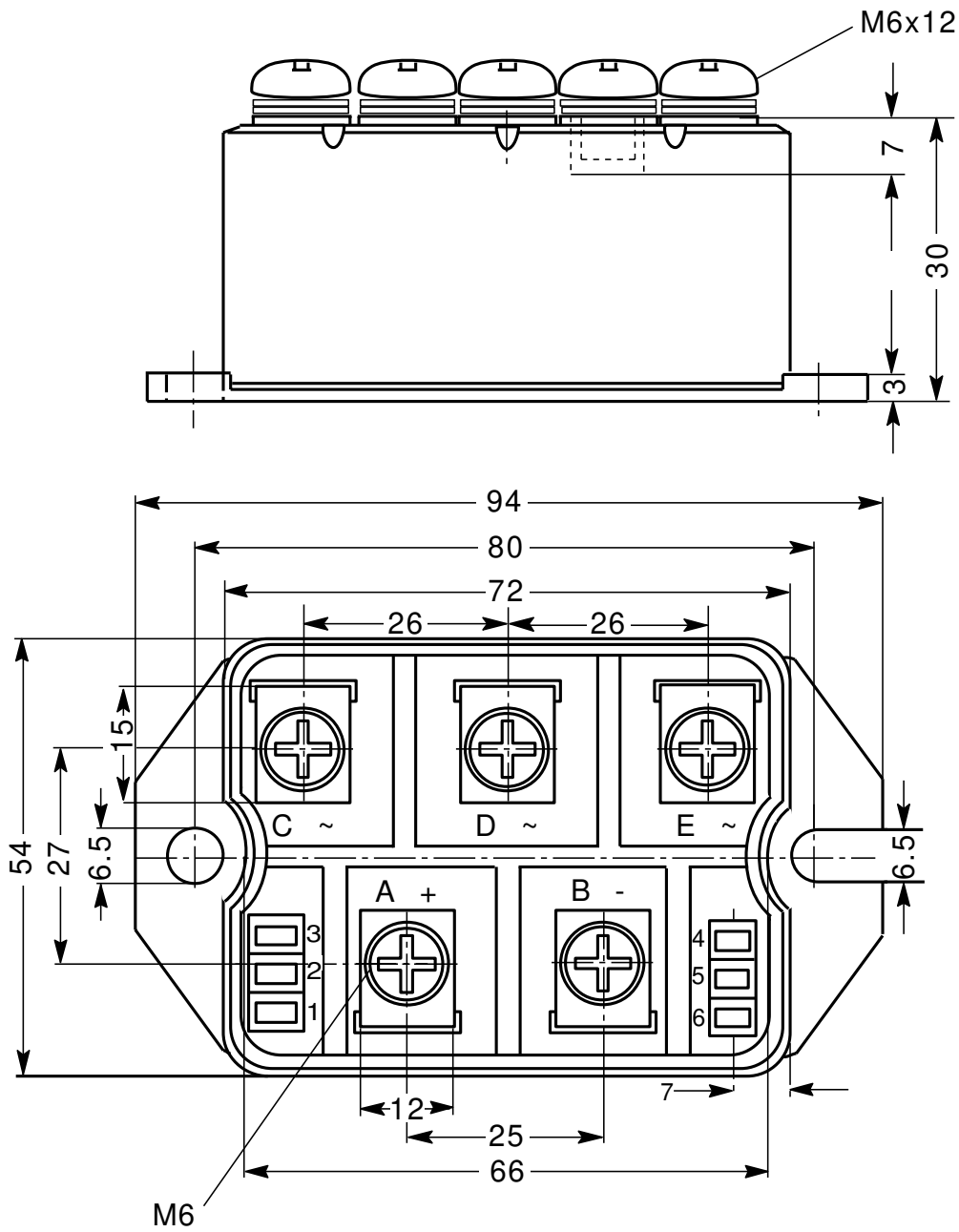



Rectifier

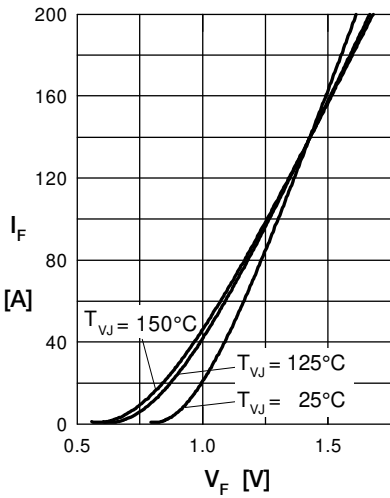

Fig. 1 Forward current vs. voltage drop per diode

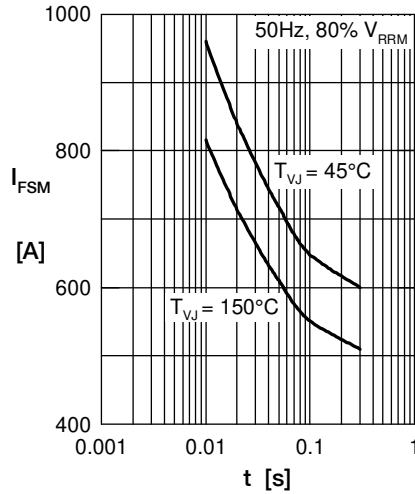

Fig. 2 Surge overload current vs. time per diode

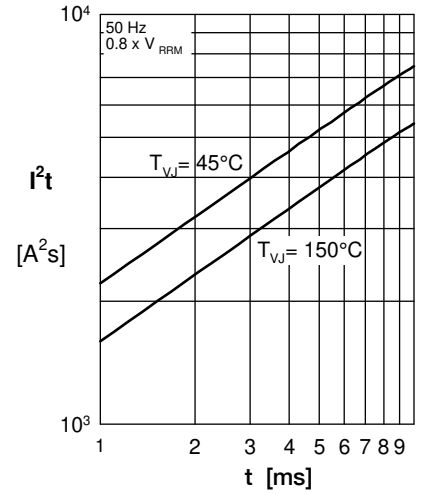

Fig. 3 I^2t vs. time per diode

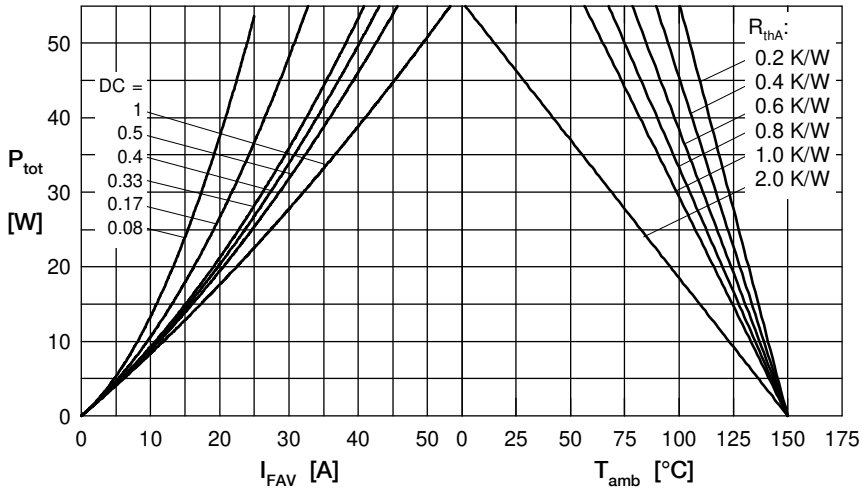

Fig. 4 Power dissipation vs. forward current and ambient temperature per diode

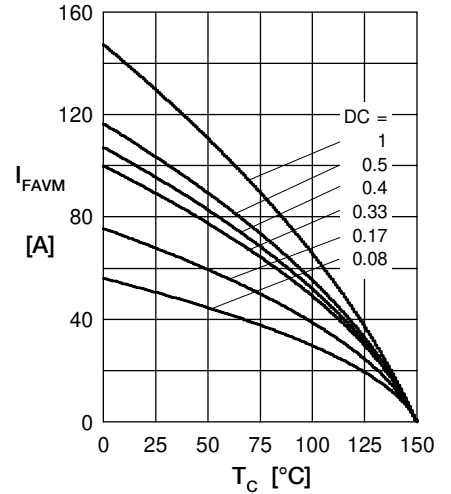

Fig. 5 Max. forward current vs. case temperature per diode

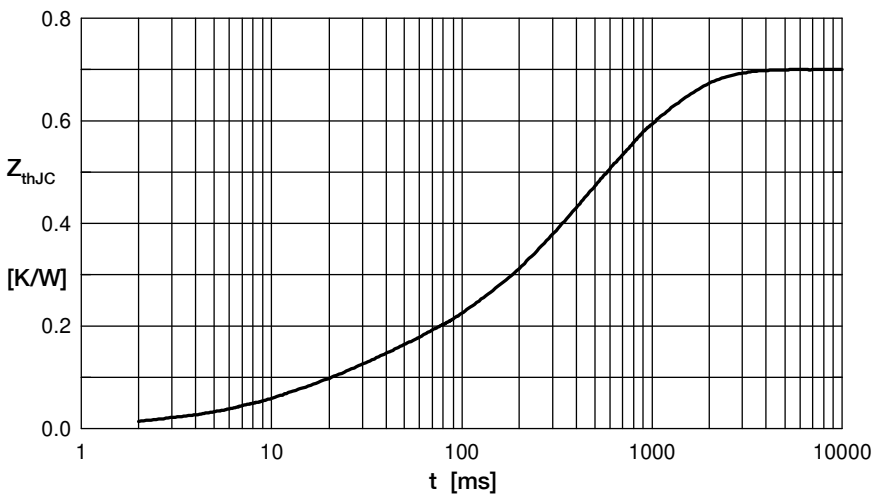

Fig. 6 Transient thermal impedance junction to case vs. time per diode

R_i	t_i
0.100	0.020
0.010	0.010
0.162	0.225
0.258	0.800
0.170	0.580