

TR Series

Radial Leaded

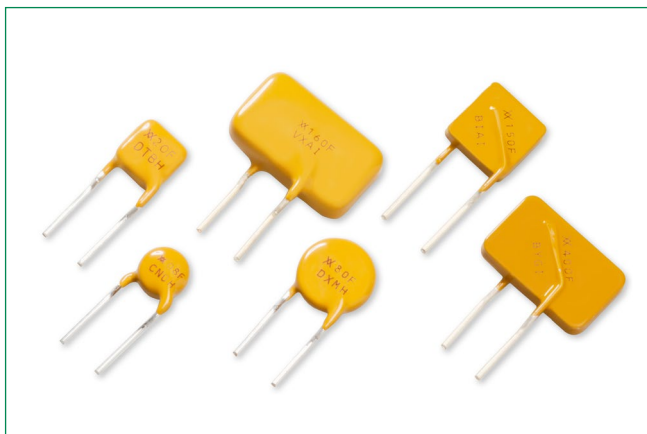

Description

Our PolySwitch® families of telecommunications and networking devices help meet the growing demand for resettable overcurrent protection. These product families help provide protection against damage caused by power cross and power induction surges as defined in ITU, Telcordia GR1089 and IEC 62368-1. Our offering includes chip, surface-mount and radial-leaded configurations.

Applications

Networking Machines and Systems

- Modems
- Phone sets
- Fax machines
- Phone wall outlets
- Alarm systems
- PBX systems
- MDF modules
- T1/E1 equipment
- Analog and digital line cards
- xDSL modems and splitters
- Powered Ethernet systems
- VoIP (Voice over Internet Protocol) equipment
- LAN, WAN equipment
- Customer premise equipment
- Access network hardware

Additional Information



Resources



Accessories



Samples

Agency Approvals

| Agency | Agency File/Certificate Number |
|--------|--------------------------------|
| | E74889* |
| | 78165* |
| | 72161780* |

* See Electrical Characteristic Table for approved part numbers.

Features & Benefits

- Resettable overcurrent protection
- Fast time-to-trip
- Resistance sorted and matched devices available
- Low parasitic capacitance/flat impedance with frequency
- Recognized to UL 1434, approved to CSA TIL No. CA-3A and EN 60730-1.



Electrical Characteristics

| Part Number | Ordering Part Number | I _H (A) | I _T (A) | V _{MAX} | | I _{MAX} | P _D TYP (W) | Typ Time-to-trip (A) (s) | R _{MIN} (Ω) | R _{MAX} (Ω) | R _{1MAX} (Ω) | Agency Approvals | | | |
|--|----------------------|-----------------------|-----------------------|--------------------|---------------------|------------------|---------------------------|-----------------------------|-------------------------|-------------------------|--------------------------|------------------|---|---|---|
| | | | | Operating | Interrupt | Interrupt | | | | | | | | | |
| | | | | (V _{DC}) | (V _{RMS}) | (A) | | | | | | | | | |
| TRF250 – Radial-leaded* – 250V_{AC} | | | | | | | | | | | | | | | |
| TRF250-055T | RF1968-000 | 0.055 | 0.170 | 60 | 250 | 3.0 | 0.6 | 0.28 | 3.5 | 15.0 | 25.0 | 35.0 | - | - | - |
| TRF250-055UT | RF1647-000 | 0.055 | 0.170 | 60 | 250 | 3.0 | 0.6 | 0.28 | 3.0 | 15.0 | 25.0 | 35.0 | - | - | - |
| TRF250-080T | RF0124-000 | 0.080 | 0.160 | 60 | 250 | 3.0 | 0.6 | 0.35 | 4.0 | 15.0 | 22.0 | 33.0 | x | x | x |
| TRF250-080U | RF0125-000 | 0.080 | 0.160 | 60 | 250 | 3.0 | 0.6 | 0.35 | 2.5 | 14.0 | 20.0 | 33.0 | x | x | x |
| TRF250-110U | RF0126-000 | 0.110 | 0.220 | 60 | 250 | 3.0 | 0.6 | 1.00 | 0.8 | 5.0 | 9.0 | 16.0 | x | x | x |
| TRF250-120 | RF0008-000 | 0.120 | 0.240 | 60 | 250 | 3.0 | 0.8 | 1.00 | 1.5 | 4.0 | 8.0 | 16.0 | x | x | x |
| TRF250-120T | RF0013-000 | 0.120 | 0.240 | 60 | 250 | 3.0 | 0.8 | 1.00 | 0.7 | 7.0 | 12.0 | 16.0 | - | - | - |
| TRF250-120S-B-0.5 | RF0430-000 | 0.120 | 0.240 | 60 | 250 | 3.0 | 0.8 | 1.00 | 1.5 | 4.0 | 8.0 | 16.0 | x | x | x |

TR Series

Radial Leaded

Electrical Characteristics

| Part Number | Ordering Part Number | I _H (A) | I _T (A) | V _{MAX} | | I _{MAX} Interrupt (A) | P _D Typ (W) | Typ Time-to-trip | | R _{MIN} (Ω) | R _{MAX} (Ω) | R _{1MAX} (Ω) | Agency Approvals | | |
|--|----------------------|-----------------------|-----------------------|--|----------------------------------|--------------------------------------|---------------------------|------------------|-----|-------------------------|-------------------------|--------------------------|---|---|---|
| | | | | Operating (V _{DC}) | Interrupt (V _{RMS}) | | | (A) | (s) | | | |  |  |  |
| | | | | TRF250 – Radial-leaded* – 250V _{AC} | | | | | | | | | | | |
| TRF250-120T-RA-B-0.5 | RF0016-000 | 0.120 | 0.240 | 60 | 250 | 3.0 | 0.8 | 1.00 | 1.2 | 7.0 | 9.0 | 16.0 | — | — | — |
| TRF250-120T-RC-B-0.5 | RF0361-000 | 0.130 | 0.260 | 60 | 250 | 3.0 | 0.8 | 1.00 | 3.0 | 5.4 | 7.5 | 14.0 | — | — | — |
| TRF250-120T-RF-B-0.5 | RF0105-000 | 0.120 | 0.240 | 60 | 250 | 3.0 | 0.8 | 1.00 | 0.9 | 6.0 | 10.5 | 16.0 | — | — | — |
| TRF250-120T-RH-B-0.5 | RF2519-000 | 0.120 | 0.240 | 60 | 250 | 3.0 | 0.8 | 1.00 | 0.7 | 9.0 | 11.0 | 16.0 | — | — | — |
| TRF250-120T-R2-B-0.5 | RF0425-000 | 0.120 | 0.240 | 60 | 250 | 3.0 | 0.8 | 1.00 | 0.8 | 8.0 | 10.5 | 16.0 | — | — | — |
| TRF250-120U | RF0017-000 | 0.120 | 0.240 | 60 | 250 | 3.0 | 0.7 | 1.00 | 1.0 | 6.0 | 10.0 | 16.0 | x | x | x |
| TRF250-120UT | RF0018-000 | 0.120 | 0.240 | 60 | 250 | 3.0 | 0.7 | 1.00 | 0.7 | 7.0 | 12.0 | 16.0 | — | — | — |
| TRF250-145 | RF0021-000 | 0.145 | 0.290 | 60 | 250 | 3.0 | 0.8 | 1.00 | 2.5 | 3.0 | 6.0 | 14.0 | x | x | x |
| TRF250-145T | RF0022-000 | 0.145 | 0.290 | 60 | 250 | 3.0 | 0.8 | 1.00 | 1.5 | 5.4 | 7.5 | 14.0 | — | — | — |
| TRF250-145U | RF0027-000 | 0.145 | 0.290 | 60 | 250 | 3.0 | 0.7 | 1.00 | 2.0 | 3.5 | 6.5 | 14.0 | x | x | x |
| TRF250-180 | E46226-000 | 0.180 | 0.650 | 100 | 250 | 10.0 | 0.9 | 3.00 | 0.5 | 0.8 | 2.2 | 4.0 | x | x | x |
| TRF250-183 [‡] | RF0768-000 | 0.183 | 0.685 | 100 | 250 | 10.0 | 0.9 | 3.00 | 0.6 | 0.8 | 2.0 | 3.4 | x | x | x |
| TRF250-183U [‡] | RF0770-000 | 0.183 | 0.685 | 100 | 250 | 10.0 | 0.9 | 3.00 | 0.6 | 0.8 | 2.0 | 3.4 | x | x | x |
| TRF250-184 [‡] | RF1135-000 | 0.184 | 1.000 | 100 | 250 | 10.0 | 0.9 | 3.00 | 0.5 | 1.2 | 2.4 | 3.1 | x | x | x |
| TRF600 – Radial-leaded [†] – 600V _{AC} | | | | | | | | | | | | | | | |
| TRF600-150 | A87878-000 | 0.150 | 0.300 | 250 | 600 | 3.0 | 1.4 | 1.0 | 1.4 | 6.0 | 10.0 | 17.0 | x | x | x |
| TRF600-150-RB | F95456-000 | 0.150 | 0.300 | 250 | 600 | 3.0 | 1.4 | 1.0 | 1.0 | 9.0 | 12.0 | 22.0 | — | — | — |
| TRF600-150-R2-B-0.5 | RF0023-000 | 0.150 | 0.300 | 250 | 600 | 3.0 | 1.4 | 1.0 | 1.3 | 7.0 | 10.0 | 17.0 | — | — | — |
| TR600-150F-EX | RF1302-000 | 0.150 | 0.300 | 250 | 600 | 3.0 | 1.4 | 1.0 | 5.0 | 6.0 | 12.0 | 22.0 | — | — | — |
| TR600-150F-EX-RB | RF3620-000 | 0.150 | 0.300 | 250 | 600 | 3.0 | 1.4 | 1.0 | 5.0 | 9.0 | 12.0 | 22.0 | — | — | — |
| TRF600-160 | RF0071-000 | 0.160 | 0.320 | 250 | 600 | 3.0 | 1.7 | 1.0 | 7.5 | 4.0 | 10.0 | 18.0 | x | x | x |
| TRF600-160-RA | RF0170-000 | 0.160 | 0.320 | 250 | 600 | 3.0 | 1.7 | 1.0 | 9.5 | 4.0 | 7.0 | 16.0 | — | — | — |
| TRF600-250 | RF1926-000 | 0.250 | 0.850 | 250 | 600 | 3.0 | 2.0 | 3.0 | 1.0 | 1.0 | 4.3 | 7.0 | x | x | x |
| TRF600-400 | RF0965-000 | 0.400 | 1.000 | 60 | 600 | 3.0 | 2.4 | 3.0 | 4.0 | 0.95 | 1.45 | 1.90 | x | x | x |

Notes:

I_H : Hold current: maximum current device will pass without interruption in 20°C still air.

I_T : Trip current: minimum current that will switch the device from low resistance to high resistance in 20°C still air.

V_{MAX} Operating : Maximum continuous voltage device can withstand without damage at rated current. This voltage is used for component Recognition under UL1434.

V_{MAX} Interrupt : Maximum voltage that can be safely placed across a device in its tripped state.

I_{MAX} Interrupt : Maximum fault current device can withstand without damage at rated operating voltage. This current is used for component Recognition under UL1434. Devices may trip safely under higher level power cross conditions to assist equipment in meeting the appropriate ITU, UL60950 or GR1089 industry requirements.

P_D : Power dissipated from device when in the tripped state in 20°C still air.

R_{MIN} : Minimum resistance of device as supplied at 20°C unless otherwise specified.

R_{MAX} : Maximum resistance of device as supplied at 20°C unless otherwise specified.

R_{1MAX} : Maximum resistance measured one hour post-trip or post-reflow at 20°C.

* 250V_{AC} interrupt products may help equipment pass ITU K.20, K.21 and K.45 recommendations and Telcordia GR-1089 Port Type 2 and 4 requirements.

† 600V_{AC} interrupt products may help equipment pass UL60950, TIA-968-A and GR1089 Port Type 1, 3 and 5 requirements.

‡ Product is not currently available in a resistance matched or sorted option.

TR Series

Radial Leaded

Temperature Derating

| Maximum Ambient Temperature | | | | | | | | | |
|--|-------|-------|-------|-------|-------|-------|-------|-------|-------|
| Part Number | -40°C | -20°C | 0°C | 20°C | 40°C | 50°C | 60°C | 70°C | 85°C |
| Hold Current (A) | | | | | | | | | |
| TRF250 – Radial-leaded – 250V _{AC} | | | | | | | | | |
| TRF250-055T | 0.085 | 0.076 | 0.065 | 0.055 | 0.045 | 0.041 | 0.035 | 0.030 | 0.023 |
| TRF250-055UT | 0.085 | 0.076 | 0.065 | 0.055 | 0.045 | 0.041 | 0.035 | 0.030 | 0.023 |
| TRF250-080T | 0.124 | 0.110 | 0.095 | 0.080 | 0.066 | 0.059 | 0.051 | 0.044 | 0.033 |
| TRF250-080U | 0.124 | 0.110 | 0.095 | 0.080 | 0.066 | 0.059 | 0.051 | 0.044 | 0.033 |
| TRF250-110U | 0.171 | 0.151 | 0.131 | 0.110 | 0.091 | 0.081 | 0.071 | 0.061 | 0.046 |
| TRF250-120 | 0.186 | 0.165 | 0.143 | 0.120 | 0.099 | 0.088 | 0.077 | 0.066 | 0.050 |
| TRF250-120T | 0.186 | 0.165 | 0.143 | 0.120 | 0.099 | 0.088 | 0.077 | 0.066 | 0.050 |
| TRF250-120U | 0.186 | 0.165 | 0.143 | 0.120 | 0.099 | 0.088 | 0.077 | 0.066 | 0.050 |
| TRF250-120UT | 0.186 | 0.165 | 0.143 | 0.120 | 0.099 | 0.088 | 0.077 | 0.066 | 0.050 |
| TRF250-145 | 0.225 | 0.199 | 0.172 | 0.145 | 0.119 | 0.106 | 0.093 | 0.080 | 0.060 |
| TRF250-145T | 0.225 | 0.199 | 0.172 | 0.145 | 0.119 | 0.106 | 0.093 | 0.080 | 0.060 |
| TRF250-145U | 0.225 | 0.199 | 0.172 | 0.145 | 0.119 | 0.106 | 0.093 | 0.080 | 0.060 |
| TRF250-180 | 0.279 | 0.247 | 0.213 | 0.180 | 0.147 | 0.131 | 0.115 | 0.099 | 0.074 |
| TRF250-183‡ | 0.284 | 0.251 | 0.217 | 0.183 | 0.149 | 0.133 | 0.117 | 0.101 | 0.075 |
| TRF250-183U† | 0.284 | 0.251 | 0.217 | 0.183 | 0.149 | 0.133 | 0.117 | 0.101 | 0.075 |
| TRF250-184‡ | 0.286 | 0.252 | 0.218 | 0.184 | 0.150 | 0.134 | 0.118 | 0.102 | 0.075 |
| TRF600 – Radial-leaded† – 600V _{AC} | | | | | | | | | |
| TRF600-150 | 0.239 | 0.209 | 0.180 | 0.150 | 0.121 | 0.107 | 0.093 | 0.079 | 0.057 |
| TR600-150F-EX | 0.239 | 0.209 | 0.180 | 0.150 | 0.121 | 0.107 | 0.093 | 0.079 | 0.057 |
| TRF600-160 | 0.255 | 0.223 | 0.192 | 0.160 | 0.129 | 0.114 | 0.099 | 0.084 | 0.061 |
| TRF600-250 | 0.400 | 0.350 | 0.300 | 0.250 | 0.198 | 0.170 | 0.140 | 0.117 | 0.083 |
| TRF600-400 | 0.640 | 0.560 | 0.480 | 0.400 | 0.320 | 0.270 | 0.230 | 0.190 | 0.130 |

† 600V_{AC} interrupt products may help equipment pass UL60950, TIA-968-A and GR1089 Port Type 1, 3 and 5 requirements.

‡ Product is not currently available in a resistance matched or sorted option.

Temperature Derating Curve

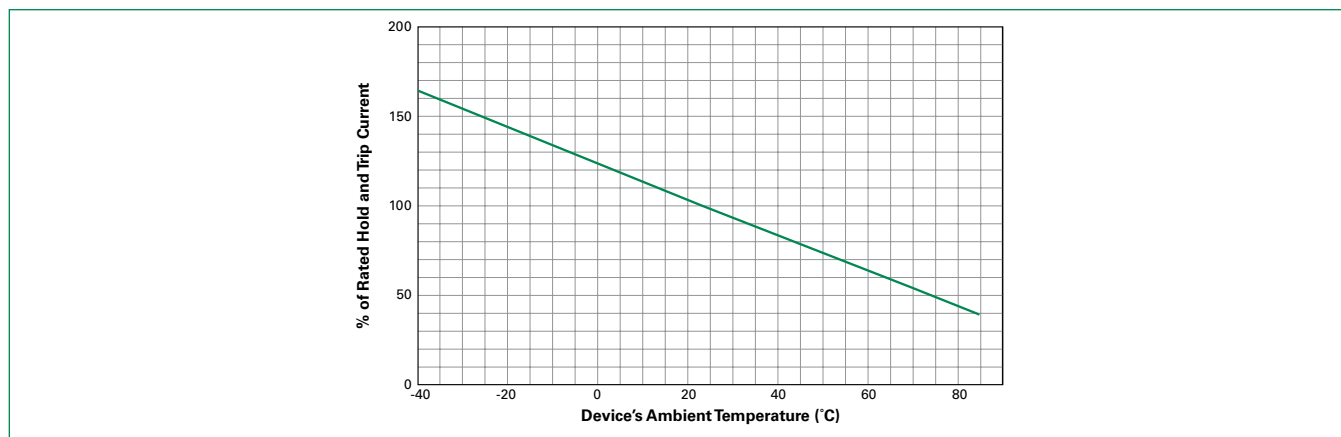

TR Series

Radial Leaded

Typical Time-to-Trip Curves at 25°C

TRF250

- A = TRF250-180/183/183U/184
- B = TRF250-145/145U/145T
- C = TRF250-120/120U
- D = TRF250-110U/120UT/120T
- E = TRF250-080T/080U
- F = TRF250-055T/055UT

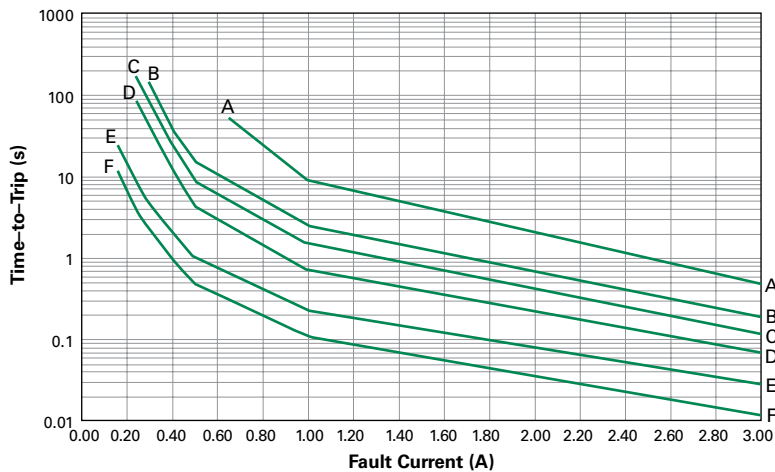

TRF600

- A = TRF600-400
- B = TRF600-250
- C = TRF600-160
- D = TR600-150F-EX
- E = TRF600-150

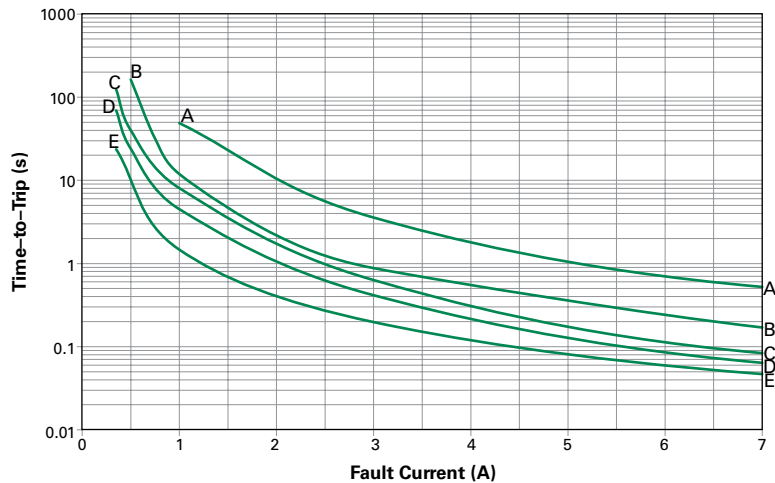

TR Series

Radial Leaded

TRF250/ TRF600 – Physical Specifications

| | |
|----------------------------------|--|
| Lead Material | Tin-plated Copper, 22AWG |
| Insulating Material | Cured Epoxy Polymer that meets UL 94 V-0 flammability rating |
| Soldering Characteristics | ANSI/J-STD-002, Category 3 |
| Solder Heat Withstand | IEC 60068-2-20, Test Tb, Section 5 Method 1 |

Note: Devices are not intended to be placed through a reflow process.

TRF250/ TRF600 – Environmental Specifications

| Test | Conditions |
|----------------------------------|--|
| Passive Aging | 60°C, 1000 hrs 85°C, 1000 hrs |
| Humidity Aging | 85°C, 85% R.H., 1000 hrs |
| Thermal Shock | 125°C, -55°C (10 Times) |
| Solvent Resistance | MIL-STD-202, Method 215F |
| Moisture Resistance Level | Level 1, J-STD-020 |
| Storage Conditions | 40°C max, 70% RH max; devices should remain in original sealed bags prior to use. Devices may not meet specified values if these storage conditions are exceeded. |

Note: Storage conditions: 40°C (max), 70% RH (max), devices should remain in original sealed bag prior to use.
Devices may not meet specified values if these storage conditions are exceeded.

Part Ordering Number System

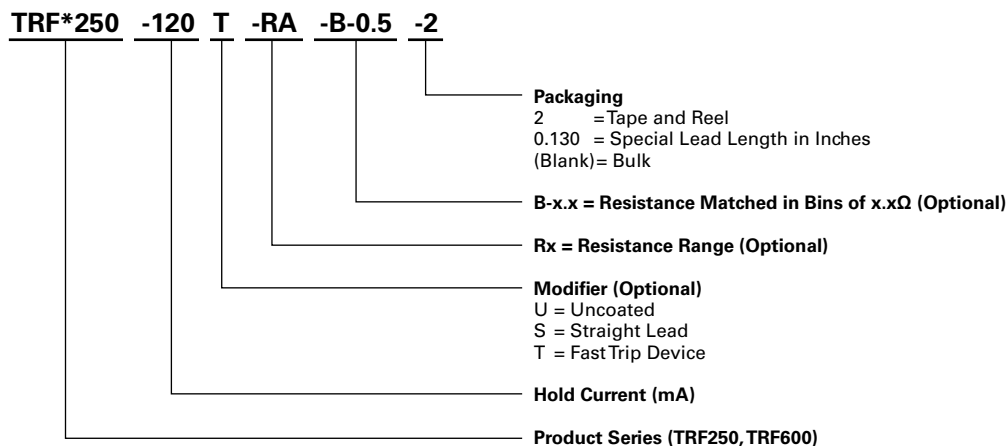

* F = RoHS compliant, ELV compliant

TR Series

Radial Leaded

Dimension Figures

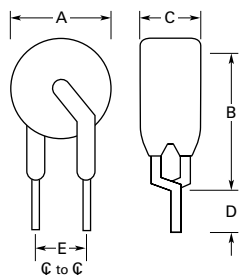

Figure 1

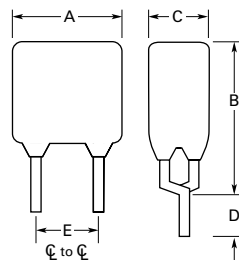

Figure 2

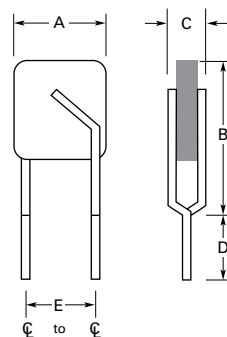

Figure 3

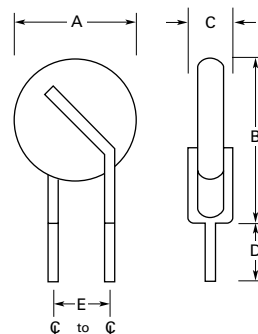

Figure 4

Dimensions and Weights

| Part Number | Dimensions in Millimeters (Inches) | | | | | | | | | | | | Figure | Device Mass (g) (Only for Reference) |
|--|------------------------------------|---------------|-----|----------------|-----|---------------|---------------|-----|----------------------------|-----|-----|---------------|--------|---|
| | A | | B | | C | | D | | E | | F | | | |
| | Min | Max | Min | Max | Min | Max | Min | Max | Min | Max | Min | Max | | |
| TRF250 – Radial-leaded* – 250V_{AC} | | | | | | | | | | | | | | |
| TRF250-055T | — | 5.8 (0.23) | — | 9.9 (0.39) | — | 4.6 (0.18) | 4.7 (0.19) | — | 5.0 [‡] (0.20) | — | — | — | 1 | 0.28 |
| TRF250-055UT | — | 4.8 (0.19) | — | 9.3 (0.37) | — | 3.8 (0.15) | 4.7 (0.19) | — | 5.0 [‡] (0.20) | — | — | — | 4 | 0.13 |
| TRF250-080T | — | 5.8 (0.23) | — | 9.9 (0.39) | — | 4.6 (0.18) | 4.7 (0.19) | — | 5.0 [‡] (0.20) | — | — | — | 1 | 0.28 |
| TRF250-080U | — | 4.8 (0.19) | — | 9.3 (0.37) | — | 3.8 (0.15) | 4.7 (0.19) | — | 5.0 [‡] (0.20) | — | — | — | 4 | 0.13 |
| TRF250-110U | — | 5.3 (0.21) | — | 9.4 (0.37) | — | 3.8 (0.15) | 4.7 (0.19) | — | 5.0 [‡] (0.20) | — | — | — | 4 | 0.13 |
| TRF250-120 | — | 6.5 (0.26) | — | 11.0 (0.43) | — | 4.6 (0.18) | 4.7 (0.19) | — | 5.0 [‡] (0.20) | — | — | — | 2 | 0.38 |
| TRF250-120T | — | 6.5 (0.26) | — | 11.0 (0.43) | — | 4.6 (0.18) | 4.7 (0.19) | — | 5.0 [‡] (0.20) | — | — | 7.0 (0.28) | 2 | 0.38 |
| TRF250-120U | — | 6.0 (0.24) | — | 10.0 (0.39) | — | 3.8 (0.15) | 4.7 (0.19) | — | 5.0 [‡] (0.20) | — | — | 6.0 (0.24) | 3 | 0.19 |
| TRF250-120UT | — | 6.0 (0.24) | — | 10.0 (0.39) | — | 3.8 (0.15) | 4.7 (0.19) | — | 5.0 [‡] (0.20) | — | — | 6.0 (0.24) | 3 | 0.19 |
| TRF250-145 | — | 6.5 (0.26) | — | 11.0 (0.43) | — | 4.6 (0.18) | 4.7 (0.19) | — | 5.0 [‡] (0.20) | — | — | 7.0 (0.28) | 2 | 0.38 |
| TRF250-145T | — | 6.5 (0.26) | — | 11.0 (0.43) | — | 4.6 (0.18) | 4.7 (0.19) | — | 5.0 [‡] (0.20) | — | — | 7.0 (0.28) | 2 | 0.38 |
| TRF250-145U | — | 6.0 (0.24) | — | 10.0 (0.39) | — | 3.8 (0.15) | 4.7 (0.19) | — | 5.0 [‡] (0.20) | — | — | 6.0 (0.24) | 3 | 0.19 |
| TRF250-180 | — | 9.0 (0.35) | — | 12.0 (0.47) | — | 3.8 (0.15) | 4.7 (0.19) | — | 5.0 [‡] (0.20) | — | — | — | 1 | 0.35 |
| TRF250-183 | — | 7.5 (0.29) | — | 10.5 (0.41) | — | 3.8 (0.15) | 4.7 (0.19) | — | 5.0 [‡] (0.20) | — | — | — | 1 | 0.30 |
| TRF250-183U | — | 6.5 (0.26) | — | 10.0 (0.39) | — | 3.0 (0.12) | 4.7 (0.19) | — | 5.0 [‡] (0.20) | — | — | — | 4 | 0.16 |
| TRF250-184 | — | 7.7 (0.30) | — | 10.5 (0.41) | — | 4.6 (0.18) | 4.7 (0.19) | — | 5.0 [‡] (0.20) | — | — | — | 1 | 0.32 |

* 250V_{AC} interrupt products may help equipment pass ITU K.20, K.21 and K.45 recommendations and Telcordia GR-1089 Port Type 2 and 4 requirements.

‡ Indicates dimension is typical, not minimum.

TR Series

Radial Leaded

Dimension Figures

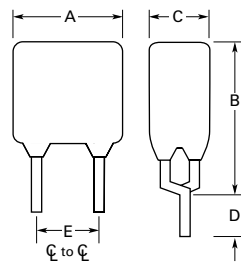

Figure 1

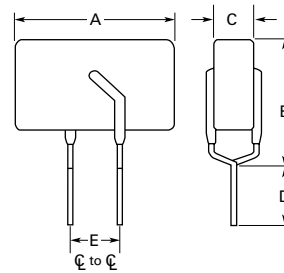

Figure 2

Dimensions and Weights

| Part Number | Dimensions in Millimeters (Inches) | | | | | | | | | | | | Figure | Device Mass (g) (Only for Reference) |
|---|------------------------------------|----------------|-----|----------------|-----|---------------|---------------|-----|----------------------------|-----|-----|----------------|--------|---|
| | A | | B | | C | | D | | E | | F | | | |
| | Min | Max | Min | Max | Min | Max | Min | Max | Min | Max | Min | Max | | |
| TRF600 – Radial-leaded – 600V_{AC} | | | | | | | | | | | | | | |
| TRF600-150 | — | 9.0 (0.35) | — | 12.5 (0.49) | — | 4.6 (0.18) | 4.7 (0.19) | — | 5.0 (0.20) | — | — | 9.0 (0.35) | 1 | 0.37 |
| TR600-150F-EX | — | 13.5 (0.53) | — | 12.6 (0.50) | — | 6.0 (0.24) | 4.7 (0.19) | — | 5.0 (0.20) | — | — | — | 2 | 0.80 |
| TRF600-160 | — | 16.0 (0.63) | — | 12.6 (0.50) | — | 6.0 (0.24) | 4.7 (0.19) | — | 5.0 [‡] (0.20) | — | — | 10.0 (0.39) | 2 | 0.90 |
| TRF600-250 | — | 15.0 (0.59) | — | 14.5 (0.57) | — | 4.6 (0.18) | 4.7 (0.19) | — | 5.0 [‡] (0.20) | — | — | 10.0 (0.39) | 1 | 0.87 |
| TRF600-400 | — | 14.8 (0.58) | — | 13.1 (0.52) | — | 4.6 (0.18) | 6.0 (0.27) | — | 5.0 [‡] (0.20) | — | — | — | 2 | 0.85 |

‡ Indicates dimension is typical, not minimum.

Wave Soldering Recommendations

Recommended Wave Soldering

- Soldering temperature profile
Temperature characteristic at component terminal with dual wave soldering

Rework

- If a device is removed from the board, it should be discarded and replaced with a new device

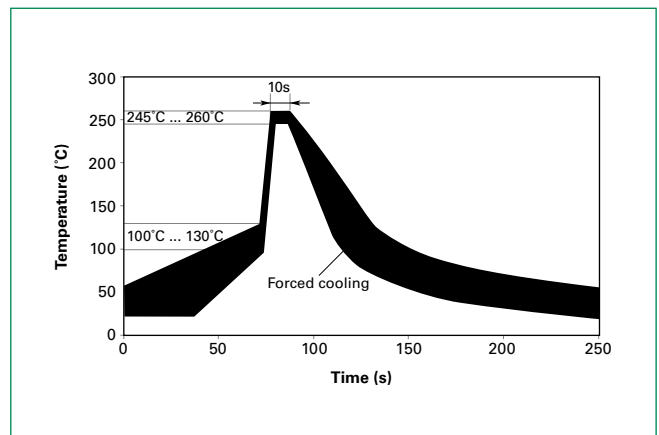

TR Series

Radial Leaded

Packaging and Marking Information

| Part Number | Bag Quantity | Tape and Reel Quantity | Standard Package Quantity | Part Marking | Agency Approvals |
|---|--------------|------------------------|---------------------------|--------------|------------------|
| TRF250 – Radial-leaded – 250V_{AC} | | | | | |
| TRF250-055T | 500 | — | 10,000 | 05F | — |
| TRF250-055UT | 500 | — | 10,000 | — | — |
| TRF250-080U | 500 | — | 10,000 | — | UL, CSA, TÜV |
| TRF250-080T | 500 | — | 10,000 | 08F | UL, CSA, TÜV |
| TRF250-110U | 500 | — | 10,000 | — | UL, CSA, TÜV |
| TRF250-120 | 500 | — | 10,000 | 20F | UL, CSA, TÜV |
| TRF250-120-2 | — | 1,500 | 7,500 | 20F | UL, CSA, TÜV |
| TRF250-120T | 500 | — | 10,000 | 20F | — |
| TRF250-120T-2 | — | 1,500 | 7,500 | 20F | — |
| TRF250-120U | 500 | — | 10,000 | — | UL, CSA, TÜV |
| TRF250-120U-2 | — | 1,500 | 7,500 | — | UL, CSA, TÜV |
| TRF250-120UT | 500 | — | 10,000 | — | — |
| TRF250-145 | 500 | — | 10,000 | 45F | UL, CSA, TÜV |
| TRF250-145-2 | — | 1,500 | 7,500 | 45F | UL, CSA, TÜV |
| TRF250-145T | 500 | — | 10,000 | 45F | — |
| TRF250-145T-2 | — | 1,500 | 7,500 | 45F | — |
| TRF250-145U | 500 | — | 10,000 | — | UL, CSA, TÜV |
| TRF250-145U-2 | — | 1,500 | 7,500 | — | UL, CSA, TÜV |
| TRF250-180 | 500 | — | 10,000 | 80F | UL, CSA, TÜV |
| TRF250-180-2 | — | 1500 | 7,500 | 80F | UL, CSA, TÜV |
| TRF250-183 | 500 | — | 10,000 | 83F | UL, CSA, TÜV |
| TRF250-183-2 | — | 1,500 | 7,500 | 83F | UL, CSA, TÜV |
| TRF250-183U | 500 | — | 10,000 | — | UL, CSA, TÜV |
| TRF250-184 | 500 | — | 10,000 | 84F | UL, CSA, TÜV |
| TRF600 – Radial-leaded – 600V_{AC} | | | | | |
| TRF600-150 | 500 | — | 10,000 | 150F | UL, CSA, TÜV |
| TRF600-150-2 | — | 1,500 | 7,500 | 150F | UL, CSA, TÜV |
| TR600-150F-EX | 500 | — | 10,000 | 150F | — |
| TR600-150F-EX-2 | — | 600 | 3,000 | 150F | — |
| TRF600-160 | 500 | — | 10,000 | 160F | UL, CSA, TÜV |
| TRF600-160-2 | — | 600 | 3,000 | 160F | UL, CSA, TÜV |
| TRF600-250 | 500 | — | 10,000 | 250F | UL, CSA, TÜV |
| TRF600-400 | 500 | — | 10,000 | 400F | UL, CSA, TÜV |

TR Series

Radial Leaded

Tape and Reel Specifications

TRF250/TRF600 devices are available in tape and reel packaging per EIA 468-B standard. See Figures 1 and 2 for details.

| Description | EIA Mark | IEC Mark | Dimension (mm) | Tolerance |
|--|-----------------|----------------|----------------|------------|
| Carrier Tape Width | W | W | 18 | -0.5/+1.0 |
| Hold Down Tape Width | W ₄ | W ₀ | 5 | Min |
| Top Distance between Tape Edges | W ₆ | W ₂ | 3 | Max |
| Sprocket Hole Position | W ₅ | W ₁ | 9 | -0.5/+0.75 |
| Sprocket Hole Diameter | D ₀ | D ₀ | 4 | ±0.2 |
| Abcissa to Plane (Straight Lead) | H | H | 18.5 | ±3.0 |
| Abcissa to Plane (Kinked Lead)* | H ₀ | H ₀ | 16 | -0.5/+0.6 |
| Abcissa to Top | H ₁ | H ₁ | 32.2 | Max |
| Overall Width with Lead Protrusion | — | C ₁ | 43.2 | Max |
| Overall Width without Lead Protrusion | — | C ₂ | 42.5 | Max |
| Lead Protrusion | L ₁ | I ₁ | 1.0 | Max |
| Protrusion of Cut-out | L | L | 11 | Max |
| Protrusion beyond Hold Down Tape | I ₂ | I ₂ | Not Specified | — |
| Sprocket Hole Pitch | P ₀ | P ₀ | 12.7 | ±0.3 |
| Device Pitch (TRF250 and TRF600-150) | — | — | 12.7 | — |
| Device Pitch (TRF600-160 - TRF600-400) | — | — | 25.4 | — |
| Pitch Tolerance | — | — | 20 Consecutive | ±1 |
| Tape Thickness | t | t | 0.9 | Max |
| Tape Thickness with Splice* | t ₁ | — | 2.0 | Max |
| Splice Sprocket Hole Alignment | — | — | 0 | ±0.3 |
| Body Lateral Deviation | Dh | Dh | 0 | ±1.0 |
| Body Tape Plane Deviation | Dp | Dp | 0 | ±1.3 |
| Lead Spacing Plane Deviation | DP ₁ | P ₁ | 0 | ±0.7 |
| Lead Spacing* | F | F | 5.08 | ±0.6 |
| Reel Width | w ₂ | w | 56 | Max |
| Reel Diameter | a | d | 370 | Max |
| Space between Flanges Less Device | w ₁ | — | 4.75 | ±3.25 |
| Arbor Hole Diameter | c | f | 26 | ±12.0 |
| Core Diameter | n | h | 80 | Max |
| Box | — | — | 56/372/372 | Max |
| Consecutive Missing Pieces* | — | — | 3 Max | — |
| Empty Places per Reel* | — | — | Not Specified | — |

* Differs from EIA specification.

TR Series Radial Leaded

Tape and Reel Diagrams

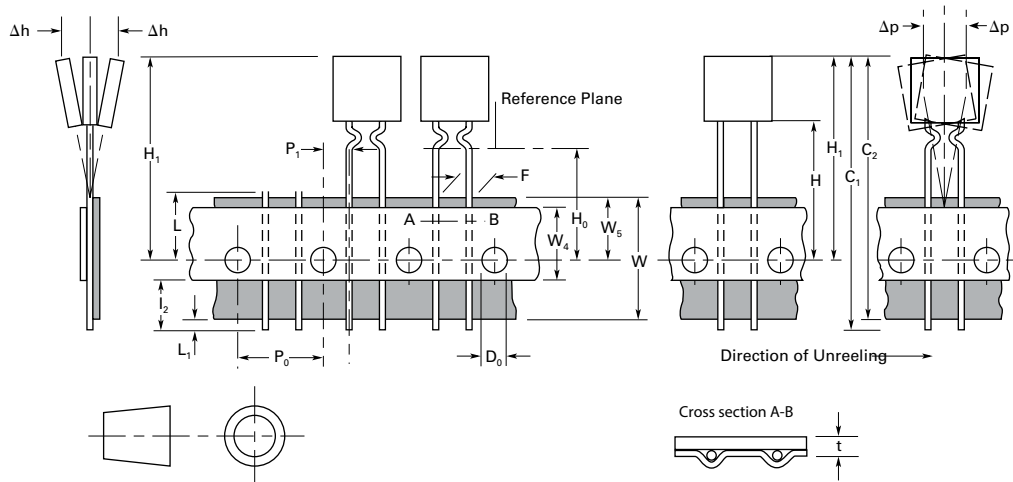

Figure 1

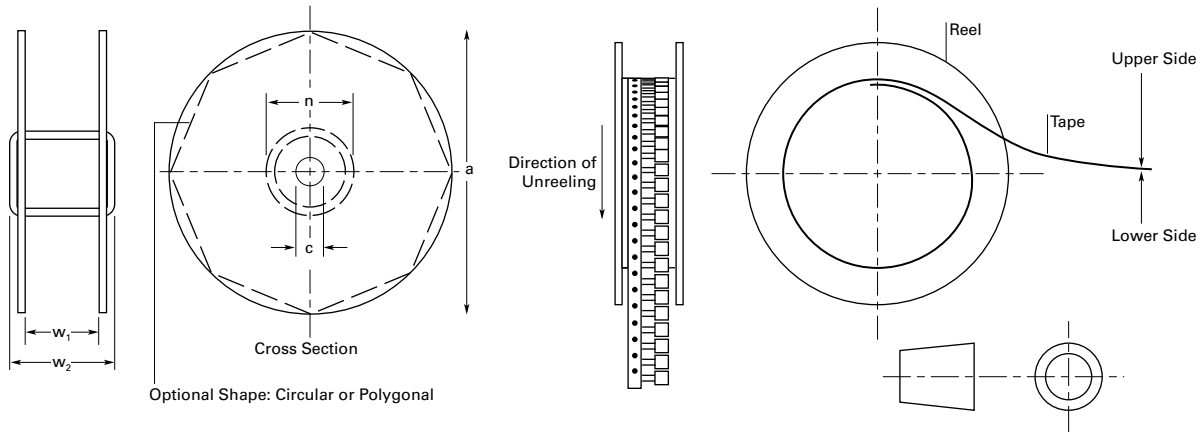

Figure 2

Warning

- Users should independently evaluate the suitability of and test each product selected for their own application.
- Operation beyond the maximum ratings or improper use may result in device damage and possible electrical arcing and flame.
- These devices are intended for protection against damage caused by occasional overcurrent or overtemperature fault conditions and should not be used when repeated fault conditions or prolonged trip events are anticipated.
- Contamination of the PPTC material with certain silicone-based oils or some aggressive solvents can adversely impact the performance of the devices.
- Device performance can be impacted negatively if devices are handled in a manner inconsistent with recommended electronic, thermal, and mechanical procedures for electronic components.
- PPTC devices are not recommended for installation in applications where the device is constrained such that its PTC properties are inhibited, for example in rigid potting materials or in rigid housings, which lack adequate clearance to accommodate device expansion.
- Operation in circuits with a large inductance can generate a circuit voltage (Ldi/dt) above the rated voltage of the device.

Disclaimer Notice - Information furnished is believed to be accurate and reliable. However, users should independently evaluate the suitability of and test each product selected for their own applications. Littelfuse products are not designed for, and may not be used in, all applications. Read complete Disclaimer Notice at www.littelfuse.com/disclaimer-electronics.