

AQ1003-01LTG, 30pF 30kV Unidirectional Discrete TVS



Description

This discrete TVS diode is fabricated in a proprietary silicon avalanche technology that protects electronic equipment I/O pins from destructive electrostatic discharges (ESDs). These robust TVSs can withstand repetitive contact or air ESD discharge events at ± 30 kV levels without suffering any performance degradation. This exceeds the ESD contact and air discharge test requirements of IEC 61000-4-2. Additionally, the TVS can withstand an 8/20 surge current event as defined in IEC 61000-4-5 2nd Edition up to 7A and still provide low voltage clamping levels.

Pinout



Functional Block Diagram

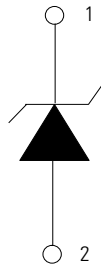

Features

- ESD, IEC 61000-4-2, ± 30 kV contact, ± 30 kV air
- EFT, IEC 61000-4-4, 40A (5/50ns)
- Lightning, 7A (8/20 μ s as defined in IEC 61000-4-5 2nd Edition)
- Low leakage current of 100nA (MAX) at 5V
- PPAP capable
- AEC-Q101 qualified
- Moisture Sensitivity Level (MSL -1)
- Halogen free, Lead free and RoHS compliant
- ESD, ISO 10605, 330pF 330 Ω , ± 25 kV contact, ± 30 kV air

Applications

- Mobile phones
- Smart phones
- PDAs
- Portable navigation components
- Digital cameras
- Portable medical components
- Automotive applications

Application Example

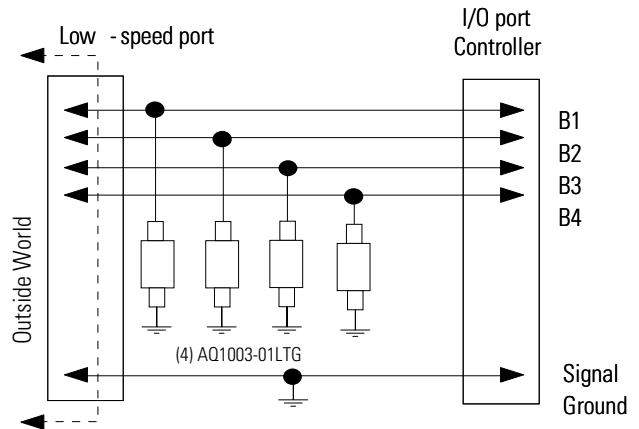

Life Support Note:

Not Intended for Use in Life Support or Life Saving Applications

The products shown herein are not designed for use in life sustaining or life saving applications unless otherwise expressly indicated.

Absolute Maximum Ratings

Symbol	Parameter	Value	Units
I_{PP}	Peak Pulse Current ($t_p=8/20\mu s$)	7.0	A
T_{OP}	Operating Temperature	-40 to 150	°C
T_{STOR}	Storage Temperature	-55 to 150	°C

CAUTION: Stresses above those listed in "Absolute Maximum Ratings" may cause permanent damage to the component. This is a stress only rating and operation of the component at conditions above the ratings indicated in this absolute maximum ratings section or in the operational sections of this specification is not implied.

Electrical Characteristics ($T_{OP}=25^\circ C$)

Parameter	Symbol	Test Conditions	Min	Typ	Max	Units
Reverse Standoff Voltage	V_{RWM}	$I_R=1\mu A$			5.0	V
Breakdown Voltage	V_{BR}	$I_R=1mA$	6.0	7.0	8.5	V
Reverse Leakage Current	I_{LEAK}	$V_R=5V$			100	nA
Clamp Voltage ¹	V_C	$I_{pp}=1A$ $t_p=8/20\mu s$, I/O to GND		8.5	11	V
		$I_{pp}=7A$ $t_p=8/20\mu s$, I/O to GND		11.5	14	V
Dynamic Resistance ²	R_{DYN}	TLP; $t_p=100ns$, I/O to GND		0.23		Ω
ESD Withstand Voltage ¹	V_{ESD}	IEC 61000-4-2 (Contact Discharge)	± 30			kV
		IEC 61000-4-2 (Air Discharge)	± 30			kV
Diode Capacitance ¹	$C_{V(O,GND)}$	Reverse Bias=0V, $f=1MHz$		30	35	pF

Note: 1 Parameter is guaranteed by design and/or component characterization.
2 Transmission Line Pulse (TLP) with 100ns width, 2ns rise time, and average window $t_1=70ns$ to $t_2=90ns$

Capacitance vs. Reverse Bias

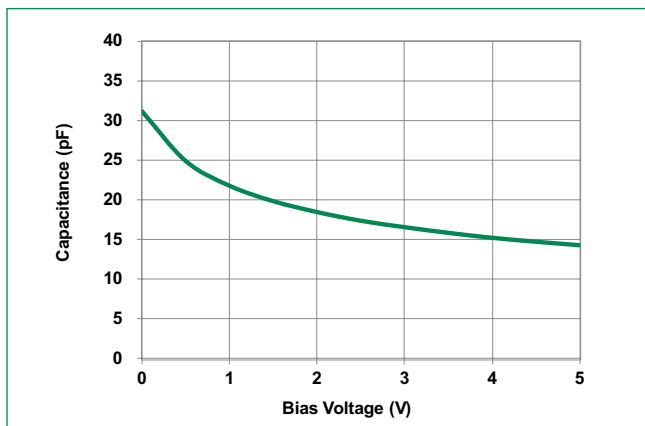

Clamping Voltage vs. I_{PP} for 8/20 μs waveshape

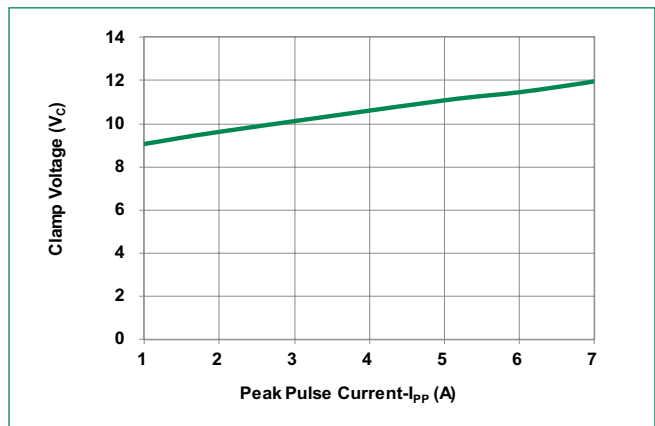

Positive Transmission Line Pulsing(TLP) Plot

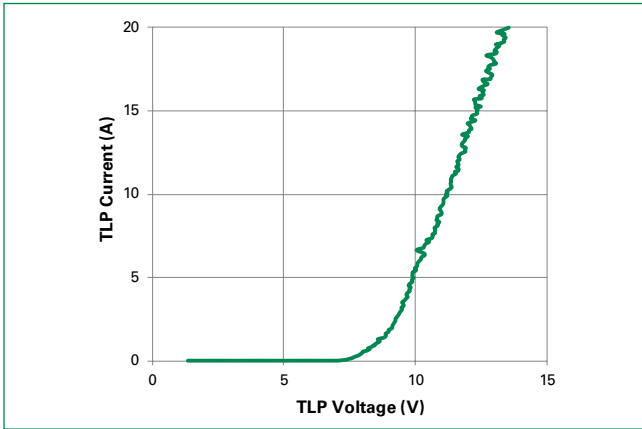

Negative Transmission Line Pulsing(TLP) Plot

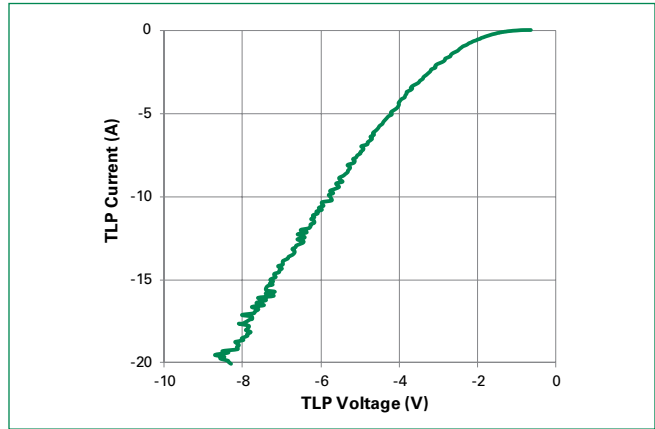

8/20µs Pulse Waveform

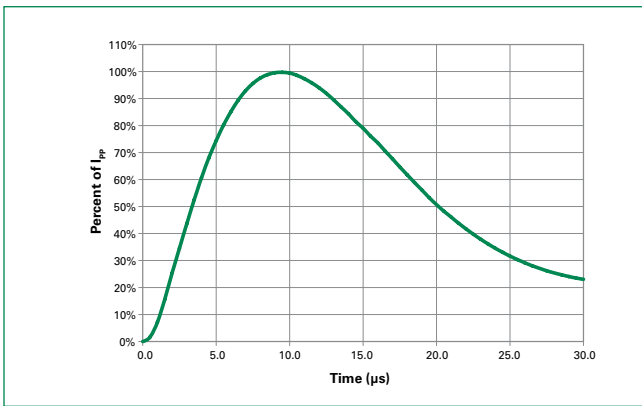

Soldering Parameters

Reflow Condition		Pb – Free assembly
Pre Heat	- Temperature Min ($T_{s(min)}$)	150°C
	- Temperature Max ($T_{s(max)}$)	200°C
	- Time (min to max) (t_s)	60 – 180 secs
Average ramp up rate (Liquidus) Temp (T_L) to peak		3°C/second max
$T_{s(max)}$ to T_L - Ramp-up Rate		3°C/second max
Reflow	- Temperature (T_L) (Liquidus)	217°C
	- Temperature (t_L)	60 – 150 seconds
Peak Temperature (T_p)		260 ^{+0.5} °C
Time within 5°C of actual peak Temperature (t_p)		20 – 40 seconds
Ramp-down Rate		6°C/second max
Time 25°C to peak Temperature (T_p)		8 minutes Max.
Do not exceed		260°C

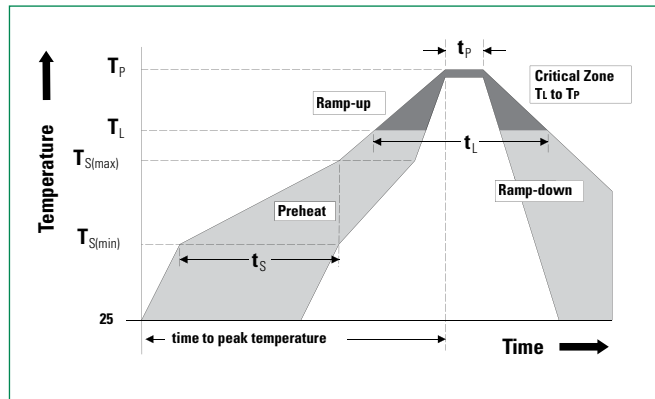

ISO10605 (C:330pF, R:330Ω) contact discharge plot at +8KV

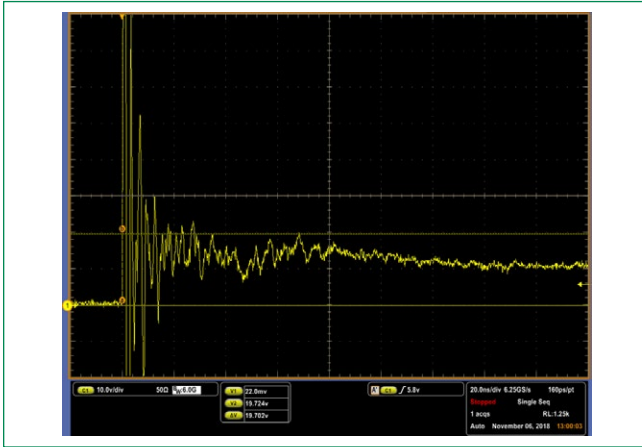

ISO10605 (C:330pF, R:330Ω) contact discharge plot at -8KV

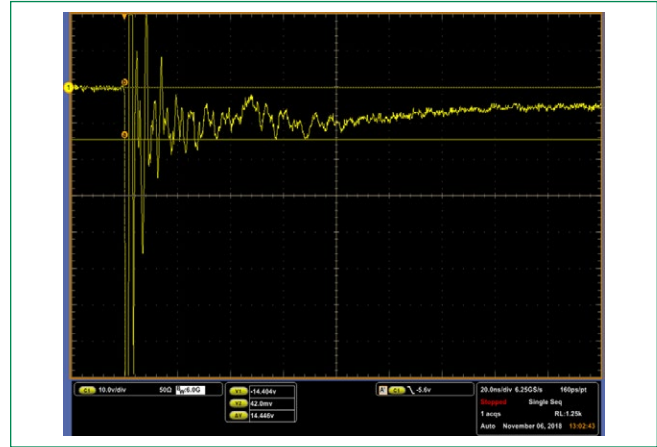

IEC61000-4-2 +8 kV Contact ESD Clamping Voltage

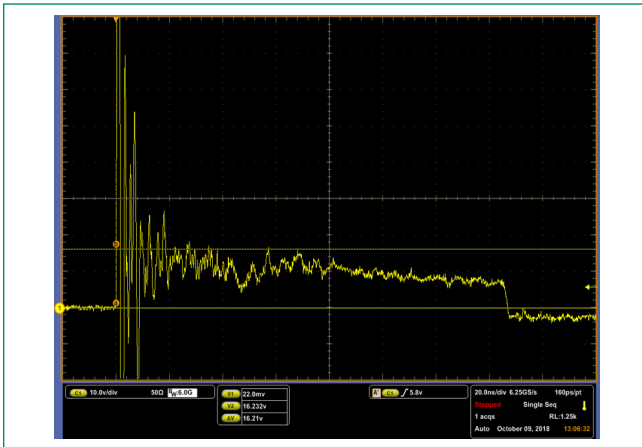

IEC61000-4-2 -8 kV Contact ESD Clamping Voltage

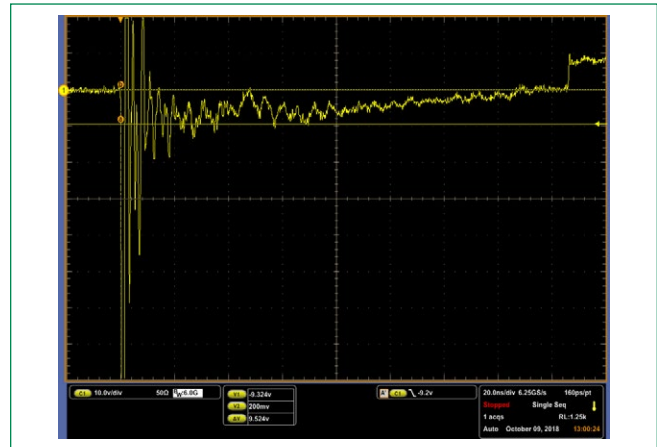

Part Numbering System

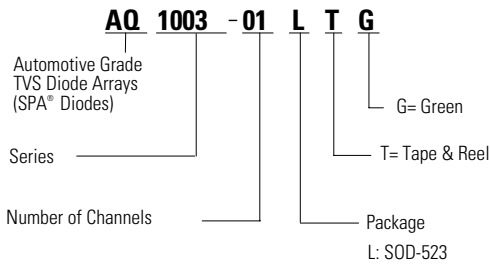

Product Characteristics

Lead Plating	Matte Tin
Lead Material	Copper Alloy
Substrate Material	Silicon
Body Material	Molded Compound
Flammability	UL Recognized compound meeting flammability rating V-0

Part Marking System

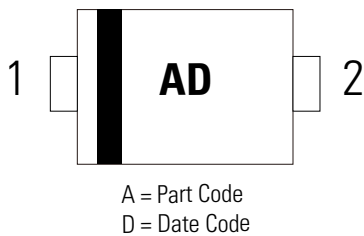

Ordering Information

Part Number	Package	Min. Order Qty.
AQ1003-01LTG	SOD-523	5000

Package Dimensions — SOD-523

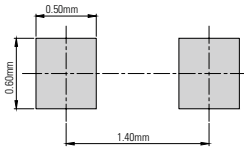
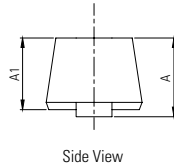
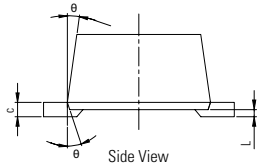
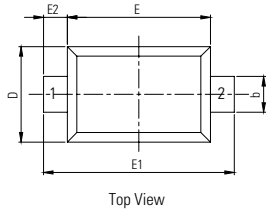

Drawing#: L01-B

Symbol	Millimeters		Inches	
	Min	Max	Min	Max
A	0.51	0.77	0.020	0.030
A1	0.50	0.70	0.020	0.028
b	0.25	0.35	0.010	0.014
c	0.08	0.15	0.003	0.006
D	0.70	0.90	0.028	0.035
E	1.10	1.30	0.043	0.051
E1	1.50	1.70	0.059	0.067
E2	0.20 REF		0.001 REF	
L	0.01	0.07	0.000	0.003
theta	7° REF		7° REF	

Embossed Carrier Tape & Reel Specification — SOD-523

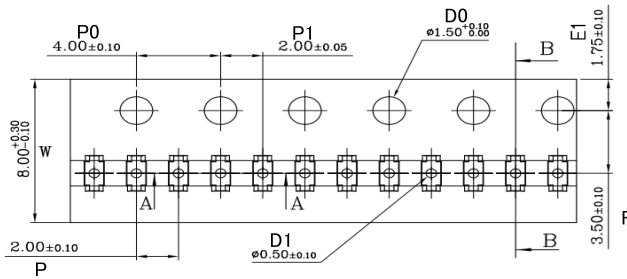

Symbol	Millimeters		Inches	
	Min	Max	Min	Max
A0	0.91	1.01	0.036	0.040
B0	1.89	1.99	0.074	0.078
D0	1.50	1.60	0.059	0.063
D1	0.40	0.60	0.016	0.024
E1	1.65	1.85	0.065	0.073
F	3.40	3.60	0.134	0.142
P0	3.90	4.10	0.154	0.161
P	1.90	2.10	0.075	0.083
P1	1.95	2.05	0.077	0.081
K0	0.68	0.78	0.027	0.031
T	0.17	0.23	0.007	0.009
W	7.90	8.30	0.311	0.327

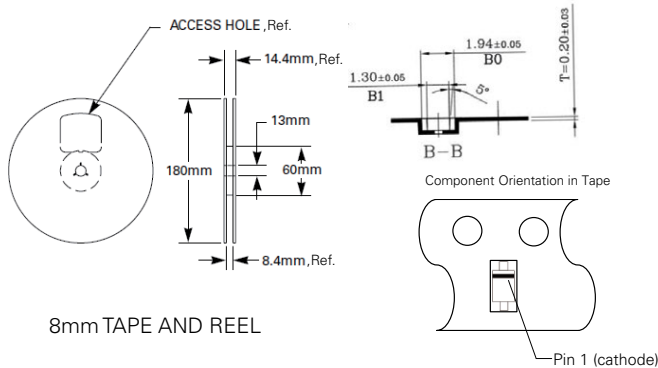

Disclaimer Notice - Information furnished is believed to be accurate and reliable. However, users should independently evaluate the suitability of and test each product selected for their own applications. Littelfuse products are not designed for, and may not be used in, all applications. Read complete Disclaimer Notice at <http://www.littelfuse.com/disclaimer-electronics>.