

MCR16NG

Silicon Controlled Rectifiers — 800V

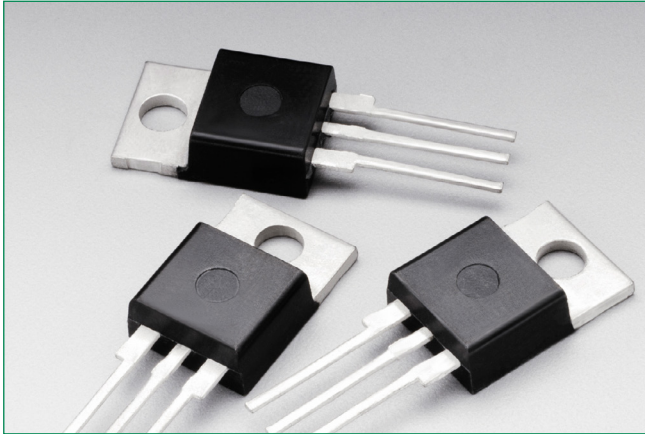

Description

Designed primarily for half-wave ac control applications, such as motor controls, heating controls, and power supplies; or wherever half-wave, silicon gate-controlled devices are needed.

Features

- Blocking Voltage to 800 Volts
- On-State Current Rating of 16 Amperes RMS
- High Surge Current Capability – 160 Amperes
- Rugged Economical TO-220AB Package
- Glass Passivated Junctions for Reliability and Uniformity
- Minimum and Maximum Values of IGT, VGT, and IH Specified for Ease of Design
- High Immunity to dv/dt – 100 V/μsec Minimum at 125°C
- These are Pb-Free Devices

Additional Information



Resources



Accessories



Samples

Functional Diagram

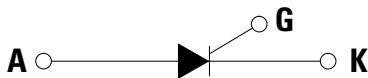

Pin Out

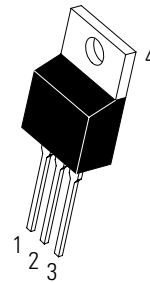

**TO-220AB
Case 221A
Style 4**

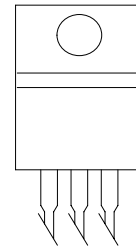

MCR16NG

Silicon Controlled Rectifiers — 800V

Maximum Ratings ($T_J = 25^\circ\text{C}$ unless otherwise noted)

Rating	Symbol	Value	Unit
Peak Repetitive Off-State Voltage (Note 1) (– 40 to 125°C, Sine Wave, 50 to 60 Hz, Gate Open)	V_{DRM} V_{RRM}	800	V
On-State RMS Current (180° Conduction Angles; $T_C = 80^\circ\text{C}$)	$I_{\text{T (RMS)}}$	16	A
Peak Non-Repetitive Surge Current (1/2 Cycle, Sine Wave 60 Hz, $T_J = 125^\circ\text{C}$)	I_{TSM}	160	A
Circuit Fusing Consideration ($t = 8.3$ ms)	I^2t	106	A ² sec
Forward Peak Gate Power (Pulse Width ≤ 1.0 μsec , $T_C = 80^\circ\text{C}$)	P_{GM}	5.0	W
Forward Average Gate Power ($t = 8.3$ msec, $T_C = 80^\circ\text{C}$)	$P_{\text{G (AV)}}$	0.5	W
Forward Peak Gate Current (Pulse Width ≤ 1.0 μsec , $T_C = 80^\circ\text{C}$)	I_{GM}	2.0	A
Operating Junction Temperature Range	T_J	-40 to 125	°C
Storage Temperature Range	T_{stg}	-40 to 150	°C

Stresses exceeding Maximum Ratings may damage the device. Maximum Ratings are stress ratings only. Functional operation above the Recommended Operating Conditions is not implied. Extended exposure to stresses above the Recommended Operating Conditions may affect device reliability.

1. V_{DRM} and V_{RRM} for all types can be applied on a continuous basis. Ratings apply for zero or negative gate voltage; however, positive gate voltage shall not be applied concurrent with negative potential on the anode. Blocking voltages shall not be tested with a constant current source such that the voltage ratings of the devices are exceeded.

Thermal Characteristics

Rating	Symbol	Value	Unit
Thermal Resistance Junction-to-Case (AC) Junction-to-Ambient	$R_{\text{B,C}}$ $R_{\text{B,A}}$	1.5 62.5	°C/W
Maximum Lead Temperature for Soldering Purposes, 1/8" from case for 10 seconds	T_L	260	°C

Electrical Characteristics - OFF ($T_C = 25^\circ\text{C}$ unless otherwise noted)

Characteristic	Symbol	Min	Typ	Max	Unit
Peak Repetitive Forward or Reverse Blocking Current ($V_{\text{AK}} = V_{\text{DRM}} = V_{\text{RRM}}$; Gate Open)	I_{DRM} I_{RRM}	-	-	0.01	mA
		-	-	2.0	mA

Electrical Characteristics - ON ($T_J = 25^\circ\text{C}$ unless otherwise noted; Electricals apply in both directions)

Characteristic	Symbol	Min	Typ	Max	Unit
Peak Forward On-State Voltage (Note 2) ($I_{\text{TM}} = 32$ A)	V_{TM}	–	–	1.7	V
Gate Trigger Current (Continuous dc) ($V_D = 12$ V; $R_L = 100$ Ω)	I_{GT}	2.0	10	20	mA
Holding Current (Anode Voltage = 12 V, Initiating Current = 200 mA, Gate Open)	I_{H}	4.0	25	40	mA
Latch Current ($V_D = 12$ V, $I_G = 200$ mA)	I_{L}	–	30	60	mA
Gate Trigger Voltage (Continuous dc) ($V_D = 12$ V, $R_L = 100$ Ω)	V_{GT}	0.5	0.65	1.0	V

Dynamic Characteristics

Characteristic	Symbol	Min	Typ	Max	Unit
Critical Rate of Rise of Off-State Voltage ($V_D = \text{Rated } V_{\text{DRM}}$; Exponential Waveform, Gate Open, $T_J = 125^\circ\text{C}$)	dv/dt	100	300	–	V/ μs
Critical Rate of Rise of On-State Current ($I_{\text{PK}} = 50$ A, $P_w = 30$ μsec , $di/dt = 1$ A/ μsec , $I_{\text{gt}} = 50$ mA)	di/dt	–	–	50	A/ μs

Product parametric performance is indicated in the Electrical Characteristics for the listed test conditions, unless otherwise noted. Product performance may not be indicated by the Electrical Characteristics if operated under different conditions.

2. Pulse Test; Pulse Width ≤ 2.0 msec, Duty Cycle $\leq 2\%$.

MCR16NG

Silicon Controlled Rectifiers — 800V

Voltage Current Characteristic of SCR

Symbol	Parameter
V_{DRM}	Peak Repetitive Forward Off State Voltage
I_{DRM}	Peak Forward Blocking Current
V_{RRM}	Peak Repetitive Reverse Off State Voltage
I_{RRM}	Peak Reverse Blocking Current
V_{TM}	Maximum On State Voltage
I_H	Holding Current

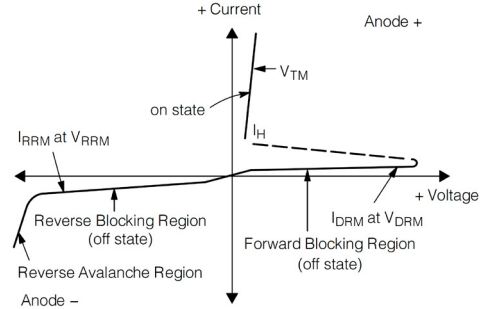

Figure 1.
Typical RMS Current Derating

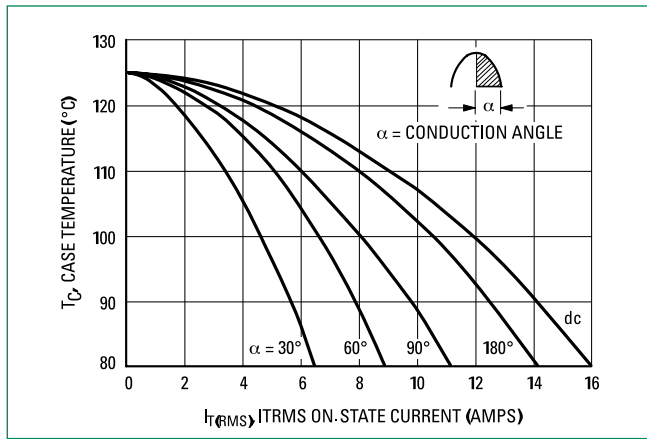

Figure 2.
On-State Power Dissipation

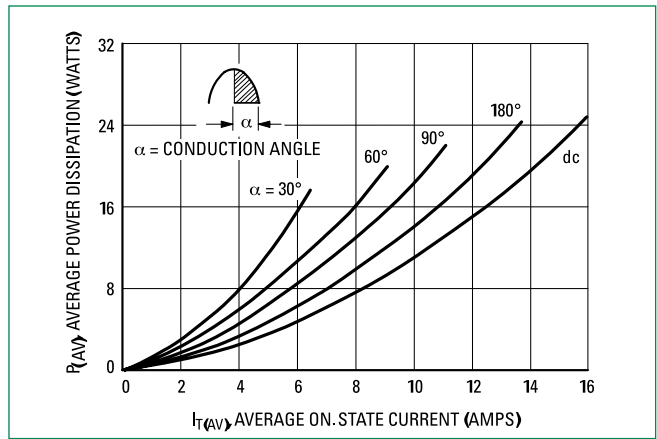

Figure 3.
Transient Thermal Response

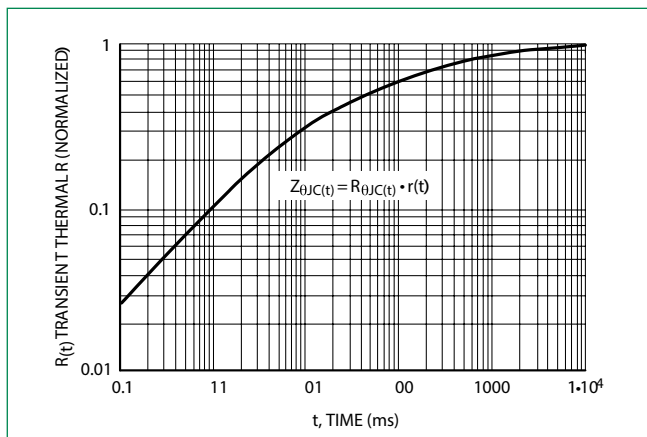
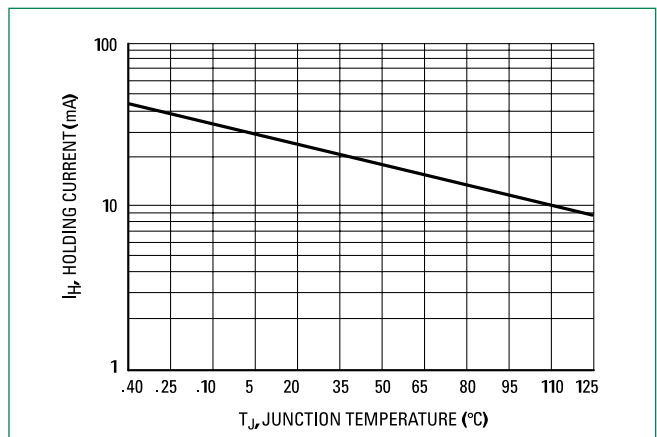

Figure 4.
Typical Holding Current vs Junction Temperature



MCR16NG

Silicon Controlled Rectifiers — 800V

Figure 5.
Typical On-State Characteristics

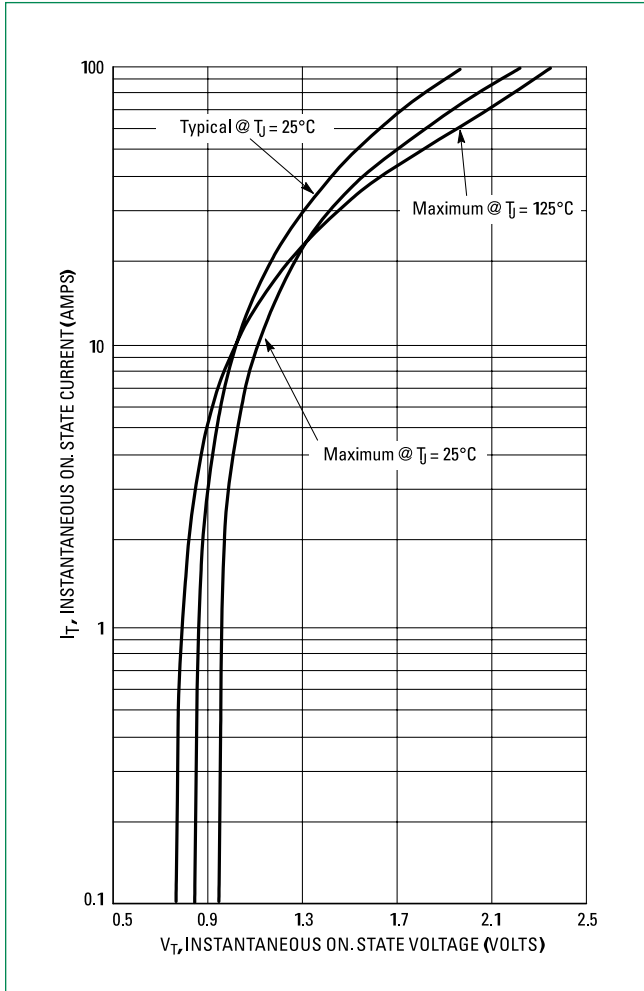

Figure 6.
Typical Latching Current vs Junction Temperature

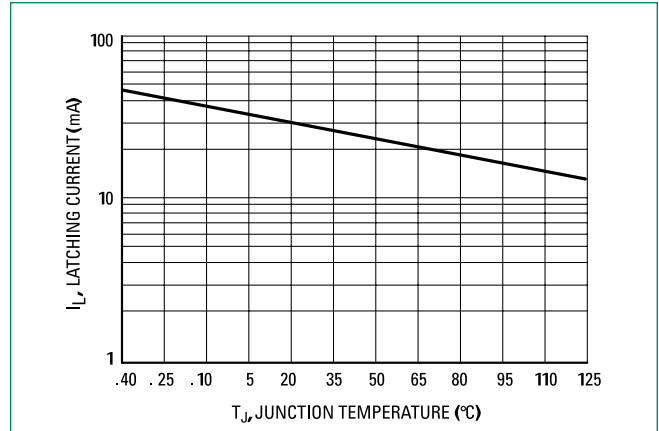

Figure 7.
Typical Gate Trigger Current vs Junction Temperature

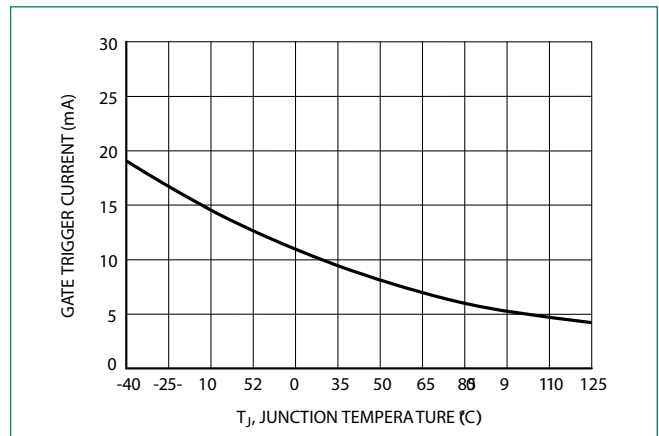

Figure 8.
Typical Gate Trigger Voltage vs Junction Temperature

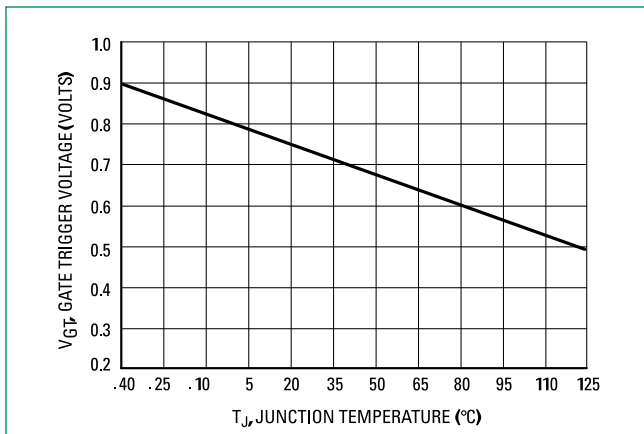
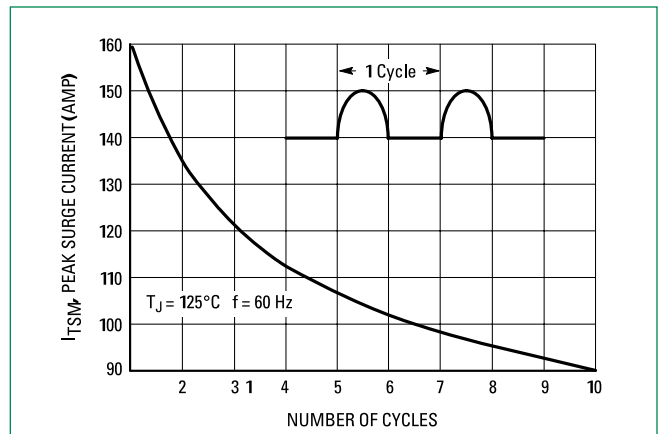

Figure 9.
Maximum Non-Repetitive Surge Current



MCR16NG

Silicon Controlled Rectifiers — 800V

Dimensions

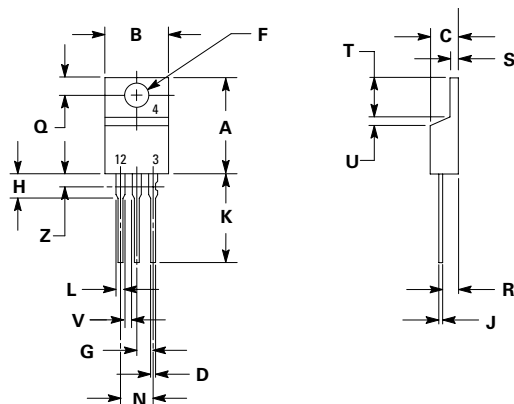

Part Marking System

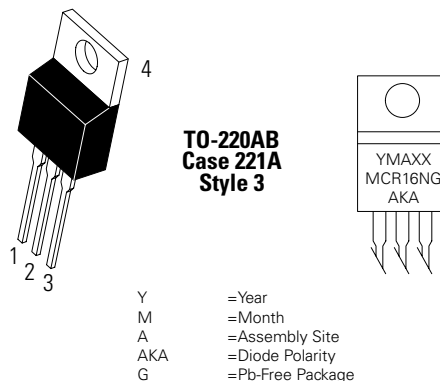

Dim	Inches		Millimeters	
	Min	Max	Min	Max
A	0.590	0.620	14.99	15.75
B	0.380	0.420	9.65	10.67
C	0.178	0.188	4.52	4.78
D	0.025	0.035	0.64	0.89
F	0.142	0.147	3.61	3.73
G	0.095	0.105	2.41	2.67
H	0.110	0.130	2.79	3.30
J	0.018	0.024	0.46	0.61
K	0.540	0.575	13.72	14.61
L	0.060	0.075	1.52	1.91
N	0.195	0.205	4.95	5.21
Q	0.105	0.115	2.67	2.92
R	0.085	0.095	2.16	2.41
S	0.045	0.060	1.14	1.52
T	0.235	0.255	5.97	6.47
U	0.000	0.050	0.00	1.27
V	0.045	---	1.15	---
Z	---	0.080	---	2.04

Pin Assignment	
1	Cathode
2	Anode
3	Gate
4	Anode

Ordering Information

Device	Package	Shipping
MCR16NG	TO-220AB (Pb-Free)	1000 Units / Box

1. Dimensioning and tolerancing per ansi y14.5m, 1982.
 2. Controlling dimension: inch.
 3. Dimension z defines a zone where all body and lead irregularities are allowed.