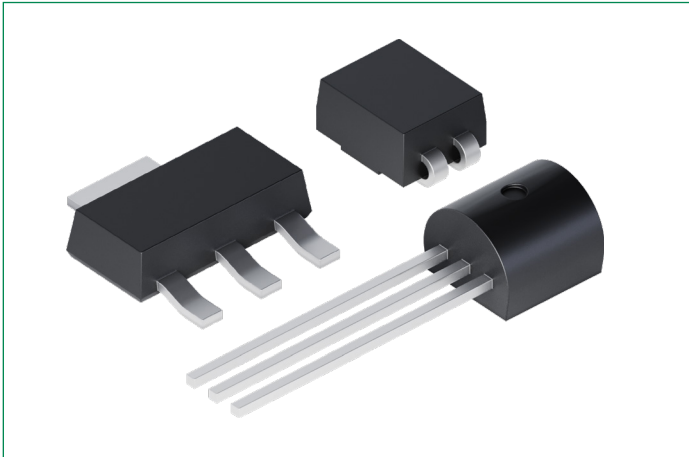

S6002xS Series

EV Series 2 A Sensitive SCRs

HF RoHS

Description

The S6002xS series offers very high di/dt capability through small die planar construction design. It is glass-passivated to ensure long term reliability and parametric stability.

Features

- Surge current capability > 24 A
- High di/dt capability of 500 A/μs
- Blocking voltage (V_{DRM}/V_{RRM}) capability up to 600 V
- Improved turn-off time (t_q) < 55 μs
- Sensitive gate for direct microprocessor interface
- RoHS compliant and halogen-free
- Through-hole and surface mount packages

Pinout Diagram

SOT-223

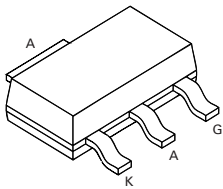

TO-92

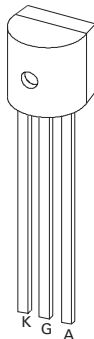

Compak

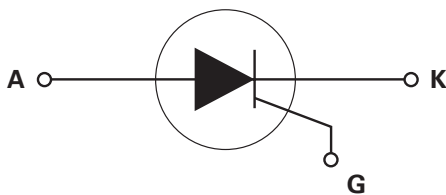
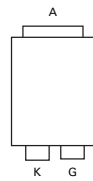

K: Cathode; **A:** Anode; **G:** Gate

Applications

These devices are specifically designed for capacitor discharge applications such as high-power gas flame ignition.

Product Summary

Characteristic	Value	Unit
$I_{T(RMS)}$	2	A
V_{DRM}/V_{RRM}	600	V
I_{GT}	200	μA

Maximum Ratings

Symbol	Characteristics	Conditions			Value	Units
$I_{T(RMS)}$	On-state RMS Current	TO-92	$T_C = 65\text{ }^\circ\text{C}$	Full sine wave	2	A
		SOT-223	$T_C = 95\text{ }^\circ\text{C}$			
		Compak	$T_C = 75\text{ }^\circ\text{C}$			
$I_{T(AV)}$	Average On-state Current	TO-92	$T_C = 65\text{ }^\circ\text{C}$		1.2	A
		SOT-223	$T_C = 95\text{ }^\circ\text{C}$			
		Compak	$T_C = 75\text{ }^\circ\text{C}$			
I_{TSM}	Non-repetitive Surge Peak On-state Current	TO-92 SOT-223 Compak	f = 50 Hz	T_{vj} initial = 25 °C, Full cycle	22.5	A
			f = 60 Hz		25	
I^2t	I^2t Value for Fusing	f = 50 Hz		$t_p = 10\text{ ms}$	2.5	A ² s
di/dt	Critical Rate of Rise of On-state Current	TO-92 SOT-223 Compak	$I_G = 10\text{ mA}$	$T_{vj} = 125\text{ }^\circ\text{C}$	500	A/ μs
I_{GM}	Peak Gate Current	$t_p = 20\text{ }\mu\text{s}$		$T_{vj} = 125\text{ }^\circ\text{C}$	1.0	A
$P_{G(AV)}$	Average Gate Power Dissipation	$T_{vj} = 125\text{ }^\circ\text{C}$			0.2	W
T_{stg}	Storage Temperature Range	–			–40 to 150	°C
T_{vj}	Virtual Junction Temperature Range	–			–40 to 125	°C

Electrical Characteristics ($T_{vj} = 25\text{ }^\circ\text{C}$, unless otherwise specified)

Symbol	Characteristics	Conditions	Value		Units	
			Min.	Max.		
I_{GT}	DC Gate Trigger Current	$V_D = 6\text{ V}, R_L = 100\text{ }\Omega$	20	200	μA	
V_{GT}	DC Gate Trigger Voltage	$V_D = 6\text{ V}, R_L = 100\text{ }\Omega$	–	0.8	V	
V_{GRM}	Peak Reverse Gate Voltage	$I_{RG} = 10\text{ }\mu\text{A}$	5	–	V	
I_H	Holding Current	$R_{GK} = 1\text{ k}\Omega$	–	5	mA	
$dv/dt_{(cr)}$	Critical Rate-of-rise of Off-stage Voltage	$T_{vj} = 125\text{ }^\circ\text{C}, V_D = 67\text{ }\%$ of V_{DRM} , Exponential Waveform	$R_{GK} = 1\text{ k}\Omega$	25	–	V/ μs
V_{GD}	Non-trigger Gate Voltage	$V_D = V_{DRM}, R_{GK} = 1\text{ k}\Omega, T_{vj} = 125\text{ }^\circ\text{C}$	0.2	–	V	
t_q	Turn-off Time	$I_T = 0.5\text{ A}$	–	55	μs	
t_{gt}	Turn-on Time	$I_G = 10\text{ mA}, P_W = 15\text{ }\mu\text{s}, I_T = 3.0\text{ A}_{pk}$	–	5	μs	

Thermal Characteristics

Symbol	Characteristics	Conditions	Value	Units	
$R_{th(j-c)}$	Thermal Resistance, Junction to Case (AC)	$I_T = 1.5\text{ A}_{(RMS)}$ ¹	TO-92	30	K/W
			SOT-223	15	
			Compak	25	
$R_{th(j-a)}$	Thermal Resistance, Junction to Ambient	$I_T = 1.5\text{ A}_{(RMS)}$ ¹	TO-92	160	K/W
			SOT-223	60	

Note 1: 60 Hz AC resistive load condition, 100% conduction

Static Characteristics ($T_{vj} = 25\text{ }^\circ\text{C}$, unless otherwise specified)

Symbol	Characteristics	Conditions	Maximum Value	Units
V_{TM}	Peak On-state Voltage	$I_{TM} = 3\text{ A}$, $t_p = 380\text{ }\mu\text{s}$	1.5	V
I_{DRM}/I_{RRM}	Repetitive Peak Off-state Current	$T_{vj} = 25\text{ }^\circ\text{C}$ @ $V_D = V_{DRM}$, $R_{GK} = 1\text{ k}\Omega$	5	μA
		$T_{vj} = 125\text{ }^\circ\text{C}$ @ $V_D = V_{DRM}$, $R_{GK} = 1\text{ k}\Omega$	500	

Characteristic Curves

Fig. 1. Normalized DC Gate Trigger Current vs. Junction Temperature

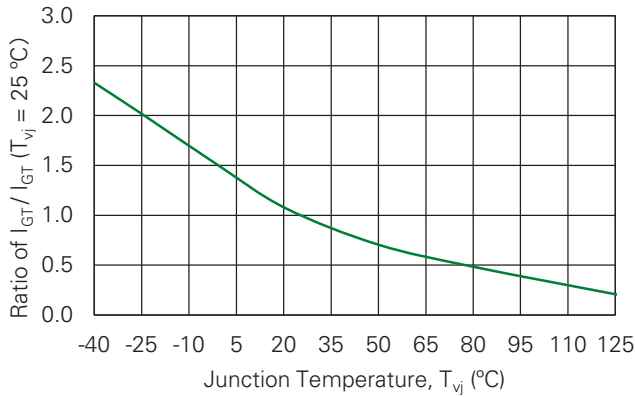

Fig. 2. Normalized DC Gate Trigger Voltage vs. Junction Temperature

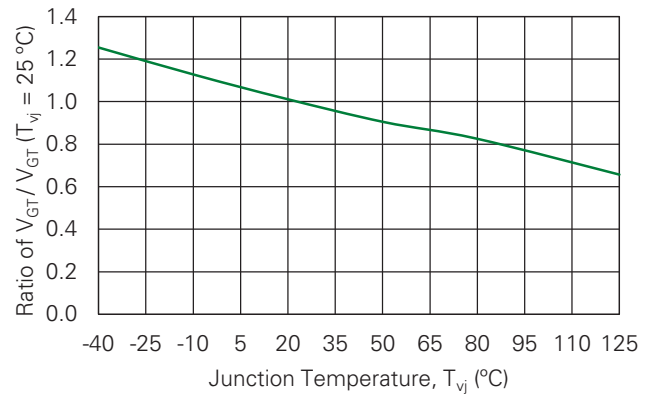

Fig. 3. Normalized DC Holding Current vs. Junction Temperature

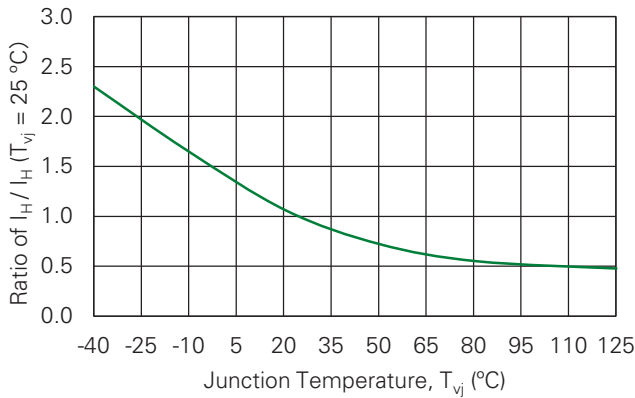

Fig. 4. Typical On-state Current vs. On-state Voltage

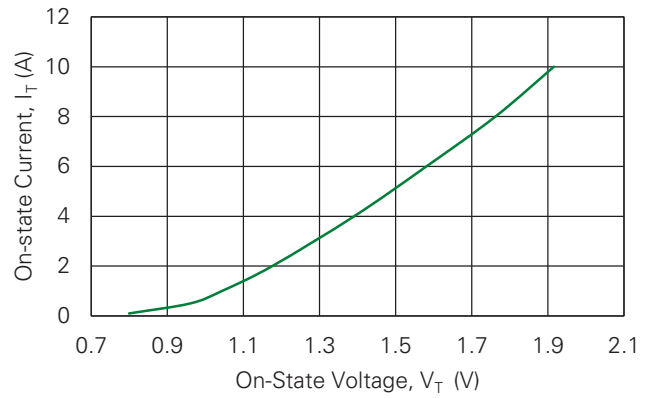

Fig. 5. Typical Power Dissipation vs. RMS On-state Current

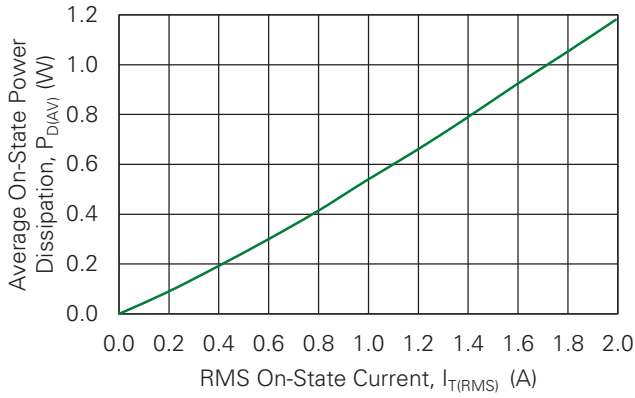

Fig. 6. Maximum Allowable Case Temperature vs. RMS On-state Current

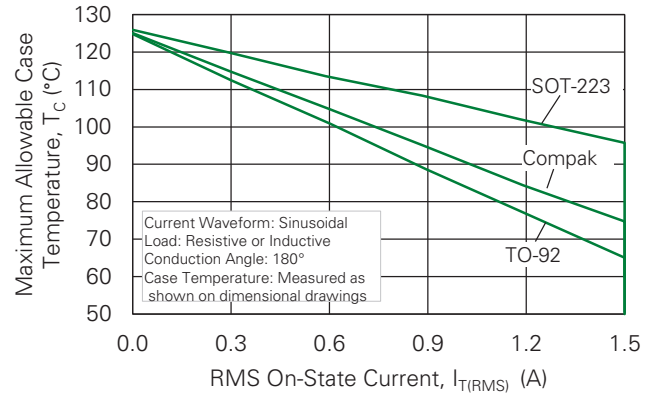

Fig. 7. Surge Peak On-state Current vs. Number of Cycles

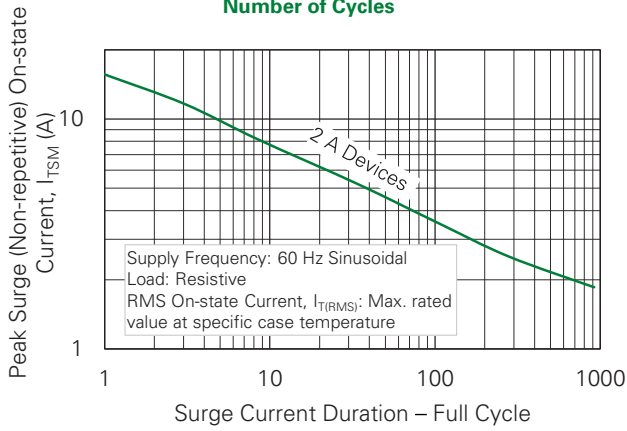
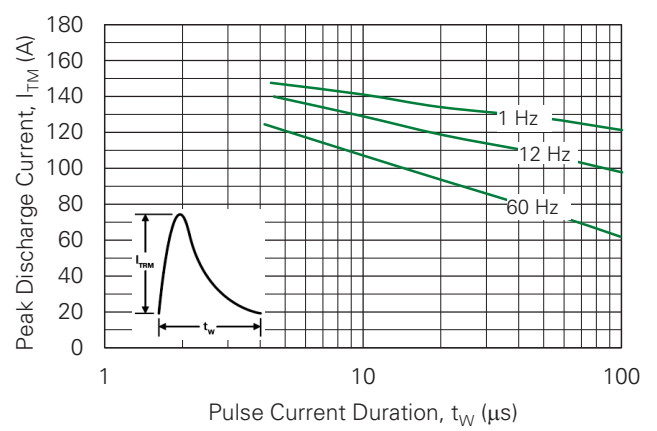

Fig. 8. Peak Repetitive Capacitor Discharge Current



Notes:

1. Gate control may be lost during and immediately following surge current interval.
2. Overload should not be repeated until junction temperature has returned to steady-state rated value.

Fig. 9. Peak Repetitive Sinusoidal Pulse Current

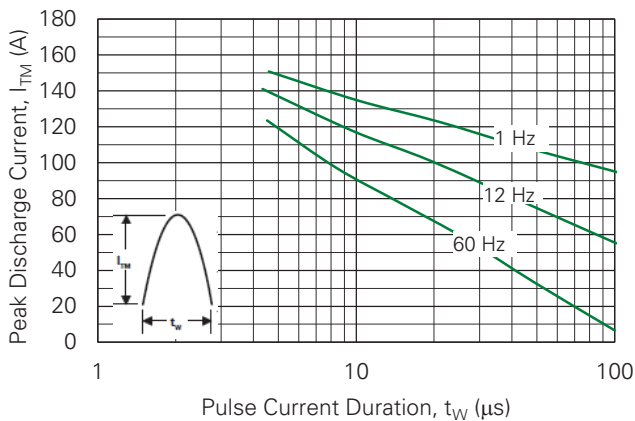

Soldering Parameters

Characteristic		Value
Reflow Condition		Pb – Free assembly
Pre-heat	Temperature Min ($T_{s(min)}$)	150°C
	Temperature Max ($T_{s(max)}$)	200°C
	Time (min to max) (t_s)	60 – 180 secs
Average ramp up rate (Liquidus Temp)(T_L) to peak		5 °C/second max
$T_{s(max)}$ to T_L - Ramp-up Rate		5 °C/second max
Reflow	Temperature (T_L) (Liquidus)	217°C
	Time (t_L)	60 – 150 seconds
Peak Temperature (T_P)		260 ^{+0/-5} °C
Time within 5°C of actual peak Temperature (t_p)		20 – 40 seconds
Ramp-down Rate		5 °C/second max
Time 25°C to peak Temperature (T_P)		8 minutes max
Do Not Exceed		280°C

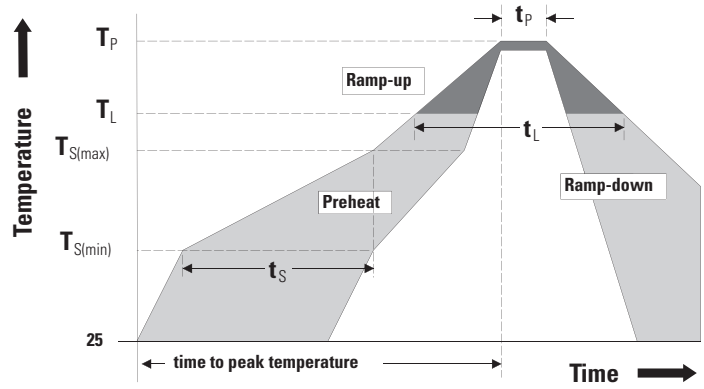

Physical Specifications

Characteristic	Value
Terminal Finish	100% Matte Tin-plated
Body Material	UL Recognized epoxy meeting flammability rating 94 V-0
Lead Material	Copper Alloy

Environmental Specifications

Test	Specifications and Conditions
AC Blocking	MIL-STD-750, M-1040, Cond A Applied Peak AC voltage @ 125 °C for 1008 hours
Temperature/Humidity	EIA / JEDEC, JESD22-A101, 1008 hours; 160 V - DC: 85 °C; 85 % relative humidity
Temperature Cycling	MIL-STD-750, M-1051, 1000 cycles; -40 °C to +150 °C; 15-min dwell-time
High-temperature Storage	MIL-STD-750, M-1031, 1008 hours; 150 °C
Low-temperature Storage	1008 hours; -40 °C
Resistance to Solder Heat	MIL-STD-750: Method 2031
Solderability	ANSI/J-STD-002: category 3, Test A
Lead Bend	MIL-STD-750, M-2036 Cond E

Product Selector

Part Number	Voltage	Gate Sensitivity	Package
	600 V		
S6002ES	X	200 µA	TO-92
S802TS	X	200 µA	SOT-223
S6002CS	X	200 µA	Compak

Packing Options

Part Number	Marking	Weight	Packing Mode	Base Quantity
S6002ES	S6002ES	0.217 g	Bulk	2500
S6002ESAP	S6002ES	0.217 g	Ammo Pack	2000
S6002ESRP	S6002ES	0.217 g	Tape & Reel	2000
S6002TSRP	S6002TS	0.120 g	Tape & Reel	1000
S6002CSR	S6002CS	0.120 g	Tape & Reel	2500

Part Numbering and Marking

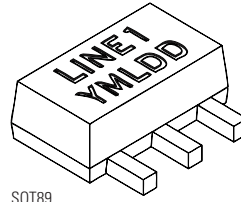
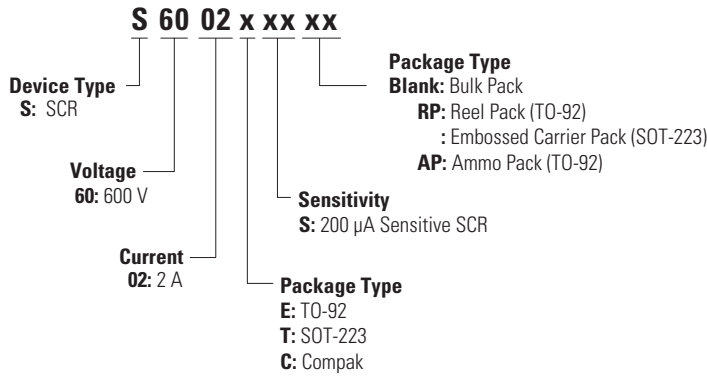

SOT89

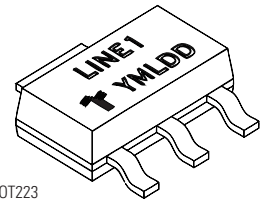

SOT223

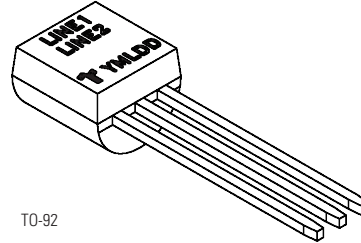

TO-92

Line1 = Littelfuse Part Number
Line2 = continuation...Littelfuse Part Number
Y = Last Digit of Calendar Year
M = Letter Month Code (A-L for Jan-Dec)
L = Location Code
DD = Calendar Date

Package Dimensions TO-92 (E Package)

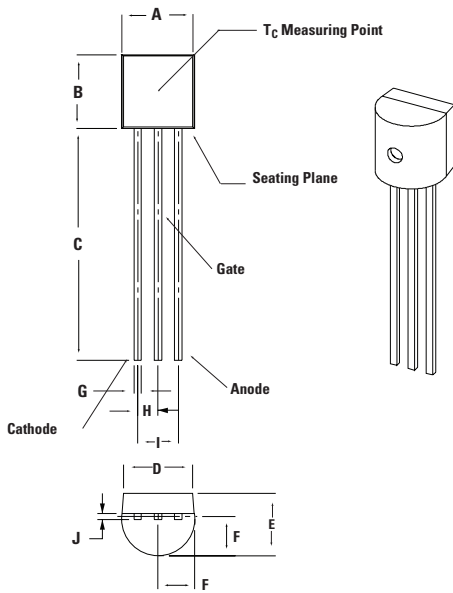

Symbol	Millimeters		Inches	
	Min.	Max.	Min.	Max.
A	4.450	5.200	0.175	0.205
B	4.320	5.330	0.170	0.210
C	12.70	–	0.500	–
D	3.430	–	0.135	–
E	3.180	4.190	0.125	0.165
F	2.040	2.660	0.080	0.105
G	0.407	0.533	0.016	0.021
H	1.150	1.390	0.045	0.055
I	2.420	2.660	0.095	0.105
J	0.380	0.500	0.015	0.020

Package Dimensions SOT-223

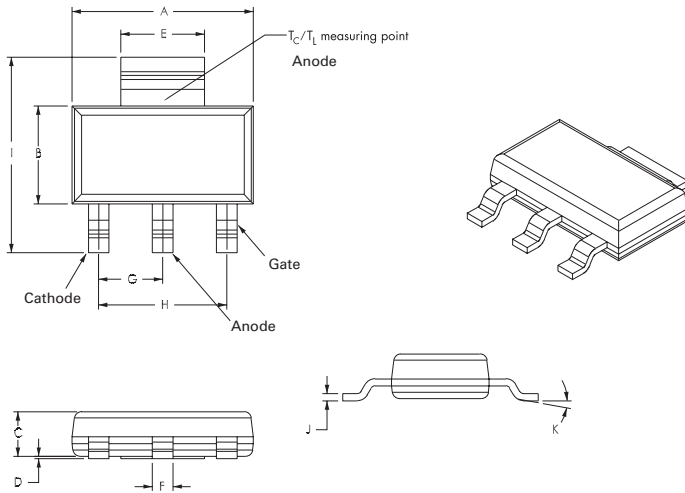

Pad Layout for SOT-223

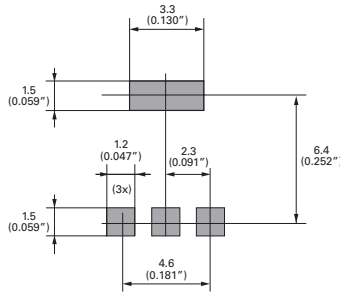

Dimensions in Millimeters (Inches)

Symbol	Millimeters			Inches		
	Min.	Typ.	Max.	Min.	Typ.	Max.
A	6.30	6.50	6.70	0.248	0.256	0.264
B	3.30	3.50	3.70	0.130	0.138	0.146
C	–	–	1.80	–	–	0.071
D	0.02	–	0.10	0.001	–	0.004
E	2.90	3.00	3.15	0.114	0.118	0.124
F	0.60	0.70	0.85	0.024	0.027	0.034
G	–	2.30	–	–	0.090	–
H	–	4.60	–	–	0.181	–
I	6.70	7.00	7.30	0.264	0.276	0.287
J	0.24	0.26	0.35	0.009	0.010	0.014
K	10° MAX.					

Package Dimensions Compak (C Package)

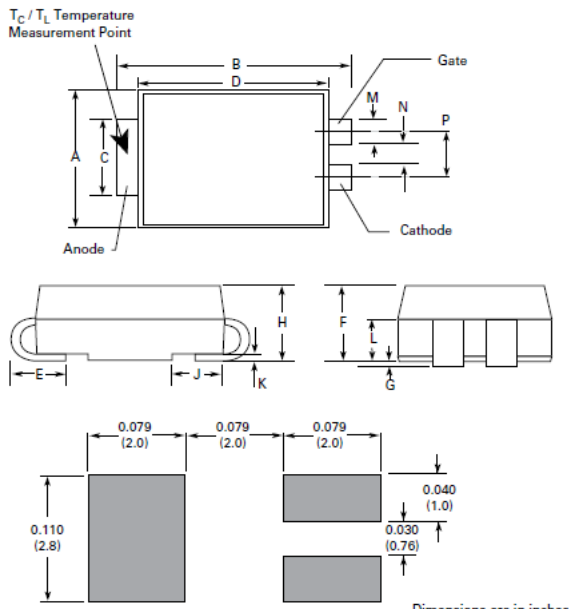

Pad Outline

Dimensions are in inches (and millimeters).

Symbol	Millimeters		Inches	
	Min.	Max.	Min.	Max.
A	3.30	3.95	0.130	0.156
B	5.10	5.60	0.201	0.220
C	1.95	2.20	0.077	0.087
D	4.05	4.60	0.159	0.181
E	0.75	1.60	0.030	0.063
F	1.90	2.45	0.075	0.096
G	0.05	0.20	0.002	0.008
H	1.95	2.65	0.077	0.104
J	1.09	1.35	0.043	0.053
K	0.15	0.41	0.006	0.016
L	0.76	1.40	0.030	0.055
M	0.56	0.71	0.022	0.028
N	0.69	0.84	0.027	0.033
P	1.32	1.47	0.052	0.058

TO-92 (3-lead) Reel Pack (RP) Radial Leaded Specifications

Meets all EIA-468-C Standards

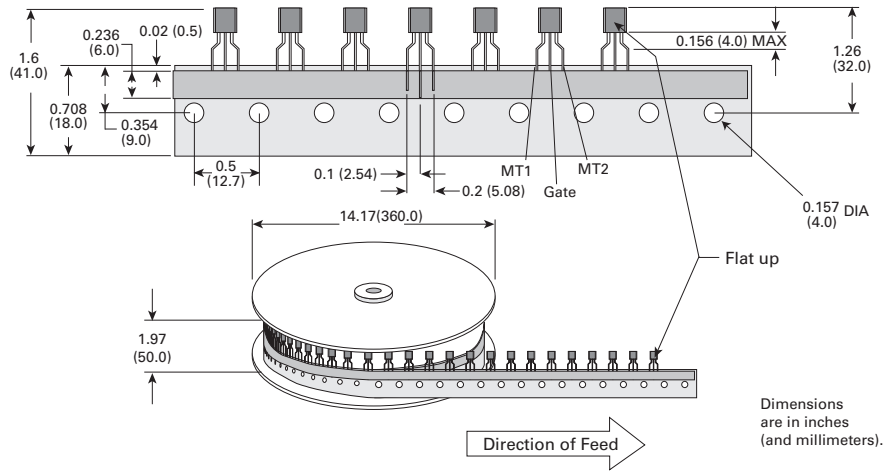

TO-92 (3-lead) Ammo Pack (AP) Radial Leaded Specifications

Meets all EIA-468-C Standards

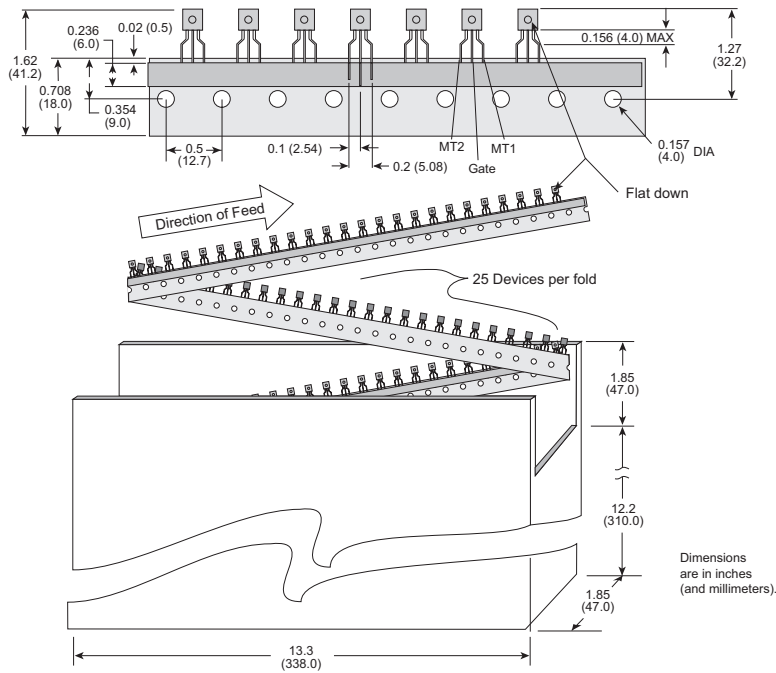

SOT-223 Reel Pack (RP) Specifications

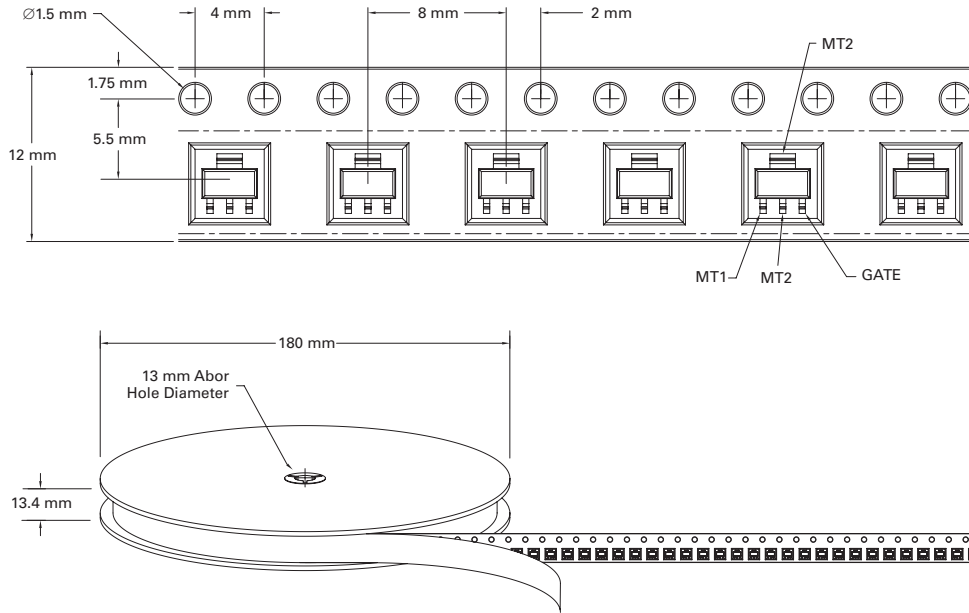

Compak Embossed Carrier Reel Pack (RP) Specifications

Meets all EIA-481-1 Standards

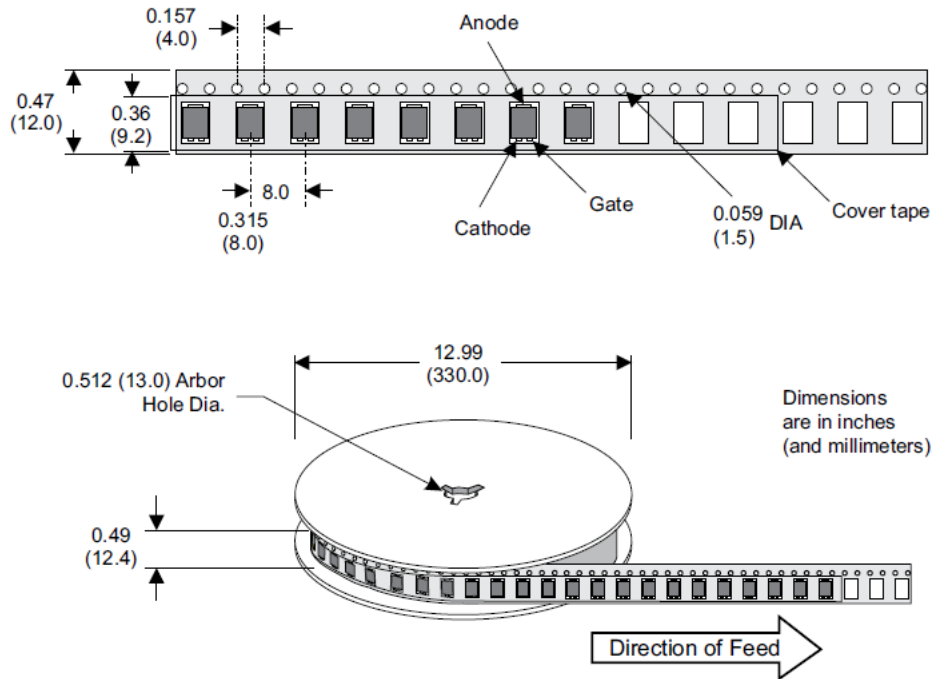

Disclaimer Notice

Information furnished is believed to be accurate and reliable. However, users should independently evaluate the suitability of and test each product selected for their own applications. Littelfuse products are not designed for, and may not be used in, all applications. Read complete Disclaimer Notice at <http://www.littelfuse.com/disclaimer-electronics>.



Part of:

