

DSA70C150HB

150 V, 2 x 35 A Schottky Diode

RoHS

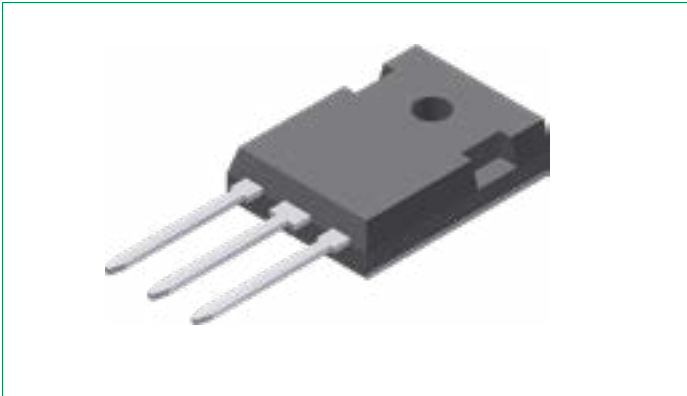

Features:

- Very low V_F
- Extremely low switching losses
- Low I_{RM} values
- Improved thermal behavior
- High reliability circuit operation
- Low voltage peaks for reduced protection circuits
- Low noise switching
- RoHS compliant
- Epoxy meets UL 94V-0

Pinout Diagram (TO-247)

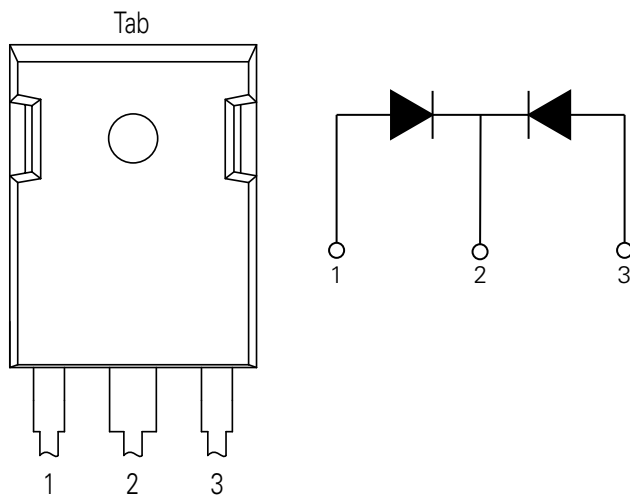

1: Anode; **2:** Cathode ; **3:** Anode; **tab:** Cathode

Applications:

- Rectifiers in Switch Mode Power Supplies (SMPS)
- Free wheeling diode in low voltage converters

Product Summary

Characteristic	Value	Unit
V_{RRM}	150	V
I_{FAV}	2 x 35	A
V_F	0.76	V

Maximum Ratings

Symbol	Characteristics	Condition	Max.	Units
V_{RSM}	Maximum Non-repetitive Reverse Blocking Voltage	–	150	V
V_{RRM}	Maximum Repetitive Reverse Blocking Voltage	–	150	V
I_{RMS}	RMS Current	per terminal	50	A
$I_{R(max)}$	Reverse Current	$V_R = 150\text{ V}, T_{VJM} = 25^\circ\text{C}$	1	mA
		$V_R = 150\text{ V}, T_{VJM} = 125^\circ\text{C}$	75	
$I_{FAV(max)}$	Average Forward Current Rectangular $d = 0.5$	$T_C = 155^\circ\text{C}, T_{VJM} = 175^\circ\text{C}$	35	A
$I_{FSM(max)}$	Maximum Forward Surge Current (Half Sine)	$t = 10\text{ ms}, (50\text{ Hz}), T_{VJM} = 45^\circ\text{C}$	500	A
$P_{tot(max)}$	Total Power Dissipation	$T_C = 25^\circ\text{C}$	215	W
T_{VJ}	Virtual Junction Temperature	–	-55 to +175	$^\circ\text{C}$
T_{op}	Operating Temperature	–	-55 to +150	$^\circ\text{C}$

Electrical Characteristics

Symbol	Characteristics	Conditions	Specification	Units
$V_{F(max)}$	Forward Voltage Drop	$I_F = 35\text{ A}; \text{ Pulse}, T_{VJM} = 25^\circ\text{C}$	0.91	V
		$I_F = 70\text{ A}; \text{ Pulse}, T_{VJM} = 25^\circ\text{C}$	0.99	
		$I_F = 35\text{ A}; \text{ Pulse}, T_{VJM} = 125^\circ\text{C}$	0.76	
		$I_F = 70\text{ A}; \text{ Pulse}, T_{VJM} = 125^\circ\text{C}$	0.87	
$V_{F0(max)}$	Threshold Voltage	$T_{VJM} = 175^\circ\text{C}$	0.58	V
$r_{F(max)}$	Slope Resistance		3.1	m Ω
$C_{J(typ)}$	Junction Capacitance	$V_R = 5\text{ V}, T_{VJM} = 25^\circ\text{C}, f = 1\text{ MHz}$	770	pF

Thermal Specifications

Symbol	Characteristics	Condition	Specification	Units
$R_{thJC(max)}$	Thermal Resistance Junction to Case	–	0.7	K/W
$R_{thCH(typ)}$	Thermal Resistance Case to Heat Sink	–	0.3	K/W

Characteristic Curves

Figure 1. Maximum Forward Voltage Drop Characteristics

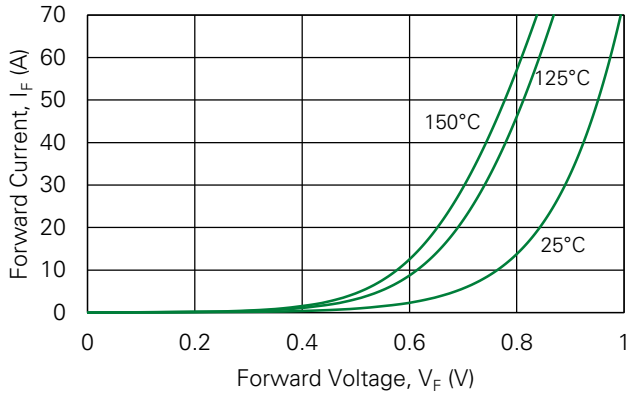

Figure 2. Typical Reverse Current vs. Reverse Voltage

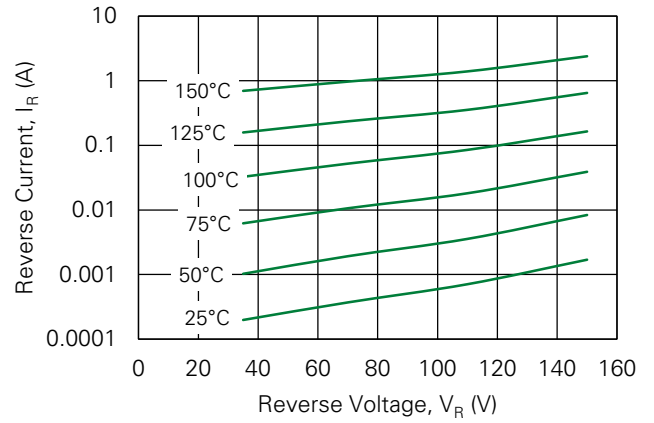

Figure 3. Typical Junction Capacitance vs. Reverse Voltage

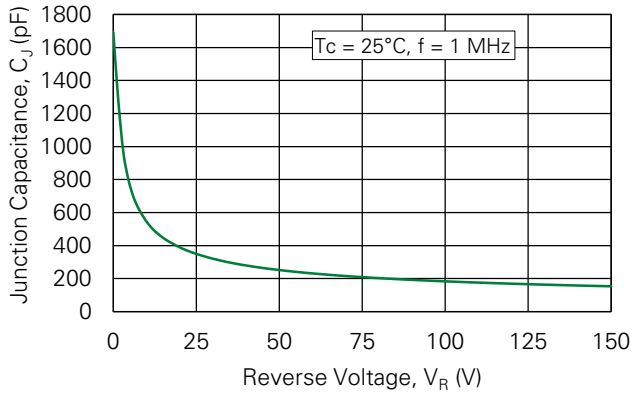

Figure 4. Average Forward Temperature vs. Case Temperature

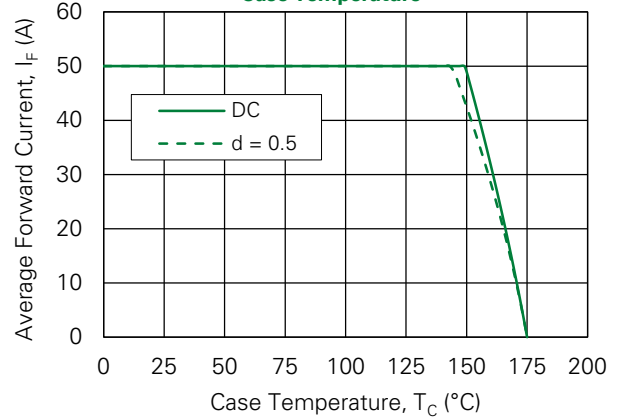

Figure 5. Forward Power Loss Characteristics

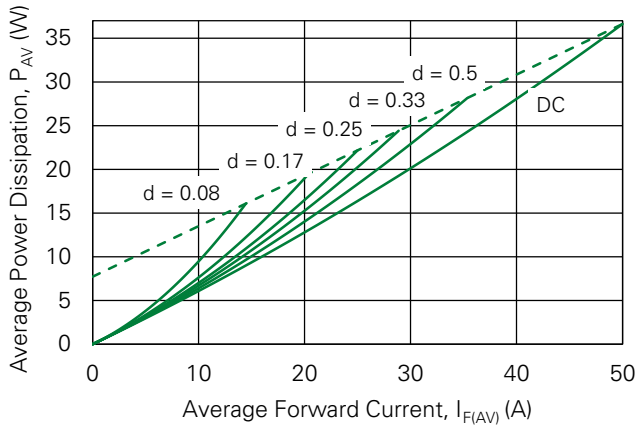
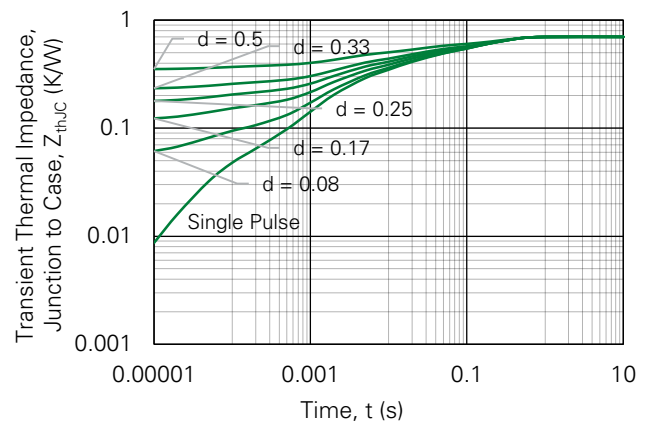
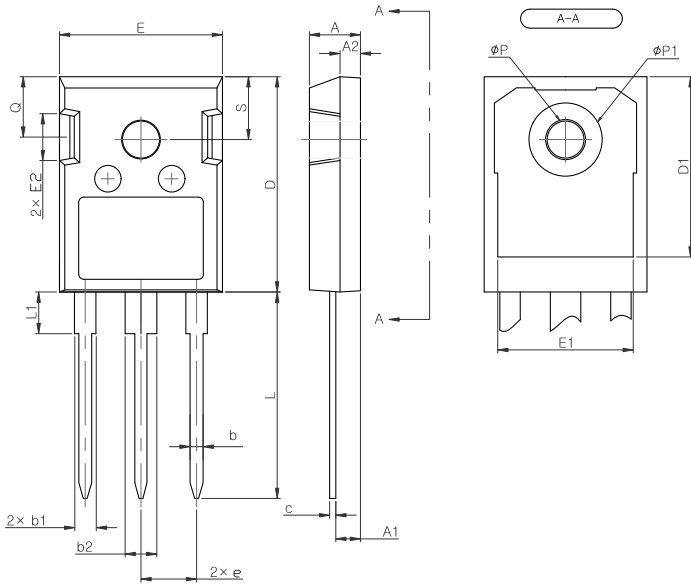

Figure 6. Transient Thermal Impedance



Part Outline Drawing (TO-247)



Symbol	Inches		Millimeters	
	Min.	Max.	Min.	Max.
A	0.189	0.205	4.80	5.20
A1	0.090	0.10	2.29	2.54
A2	0.075	0.083	1.90	2.10
b	0.043	0.051	1.10	1.30
b1	0.075	0.087	1.91	2.20
b2	0.115	0.126	2.92	3.20
c	0.020	0.027	0.50	0.70
D	0.819	0.840	20.80	21.34
D1	0.686	0.702	17.43	17.83
E	0.620	0.635	15.75	16.13
E1	0.514	0.530	13.06	13.46
E2	0.170	0.190	4.32	4.83
e	0.215 BSC		5.45 BSC	
L	0.781	0.797	19.85	20.25
L1	-	0.177	-	4.49
Ø P	0.140	0.144	3.55	3.65
Ø P1	0.281-	0.285	7.14	7.24
Q	0.220	0.244	5.59	6.19
S	0.242 BSC		6.15 BSC	

Part Number and Marking

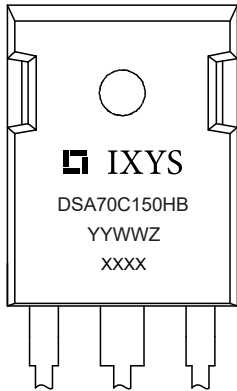

- D = Diode
- S = Schottky Diode
- A = Low V_F
- 70 = Current Rate (A)
- C = Common Cathode
- 150 = Reverse Voltage (V)
- HB TO-247AD
- YY = Year
- WW = Work Week
- Z = Plant Location Code
- xxxx = Lot Number

Ordering Information

Part Number	Marking	Packing Mode	Quantity
DSA70C150HB	DSA70C150HB	Tube	30 pcs/ tube

Disclaimer Notice

Information furnished is believed to be accurate and reliable. However, users should independently evaluate the suitability of and test each product selected for their own applications. Littelfuse products are not designed for, and may not be used in, all applications. Read complete Disclaimer Notice at <http://www.littelfuse.com/disclaimer-electronics>.



Part of:

