

# BTB16-600BW3G, BTB16-700BW3G, BTB16-800BW3G

Surface Mount – 800V



## Description

The BTB16 is designed for high performance full-wave AC control applications where high noise immunity and high commutating di/dt are required.

## Features

- Blocking Voltage to 800 V
- On-State Current Rating of 16 Amperes RMS at 80°C
- Uniform Gate Trigger Currents in Three Quadrants
- High Immunity to dV/dt – 1500 V/μs minimum at 125°C
- Minimizes Snubber Networks for Protection
- Industry Standard TO-220AB Package
- High Commutating di/dt – 7.5 A/ms minimum at 125°C
- These are Pb-Free Devices

## Additional Information



Resources



Accessories



Samples

## Functional Diagram

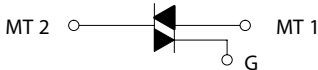

## Pin Out

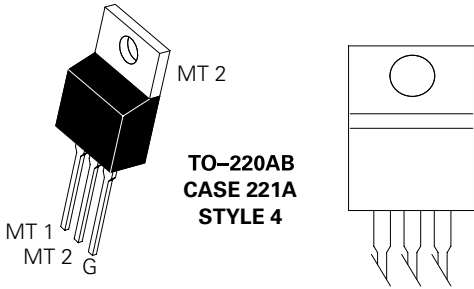

# BTB16-600BW3G, BTB16-700BW3G, BTB16-800BW3G

## Surface Mount – 800V

### Maximum Ratings ( $T_J = 25^\circ\text{C}$ unless otherwise noted)

Rating		Symbol	Value	Unit
Peak Repetitive Off-State Voltage (Note 1) (Gate Open, Sine Wave 50 to 60 Hz, $T_J = -40^\circ$ to $125^\circ\text{C}$ )	BTB16-600BW3G	$V_{\text{DRM}}^*$	600	V
	BTB16-700BW3G	$V_{\text{RRM}}$	700	
	BTB16-800BW3G		800	
On-State RMS Current (Full Cycle Sine Wave, 60 Hz, $T_C = 80^\circ\text{C}$ )		$I_{\text{T (RMS)}}$	16	A
Peak Non-Repetitive Surge Current (One Full Cycle Sine Wave, 60 Hz, $T_C = 25^\circ\text{C}$ )		$I_{\text{TSM}}$	170	A
Circuit Fusing Consideration ( $t = 8.3$ ms)		$I^2t$	120	$\text{A}^2\text{sec}$
Non-Repetitive Surge Peak Off-State Voltage ( $T_J = 25^\circ\text{C}$ , $t = 8.3$ ms)		$V_{\text{DSM}}/V_{\text{RSM}}$	$V_{\text{DSM}}/V_{\text{RSM}} + 100$	V
Peak Gate Current ( $T_J = 125^\circ\text{C}$ , $t \leq 20\mu\text{s}$ )		$I_{\text{GM}}$	4.0	W
Average Gate Power ( $T_J = 125^\circ\text{C}$ )		$P_{\text{G(AV)}}$	1.0	W
Operating Junction Temperature Range		$T_J$	-40 to +125	$^\circ\text{C}$
Storage Temperature Range		$T_{\text{stg}}$	-40 to +150	$^\circ\text{C}$

Stresses exceeding Maximum Ratings may damage the device. Maximum Ratings are stress ratings only. Functional operation above the Recommended Operating Conditions is not implied. Extended exposure to stresses above the Recommended Operating Conditions may affect device reliability.

1.  $V_{\text{DRM}}^*$  and  $V_{\text{RRM}}$  for all types can be applied on a continuous basis. Ratings apply for zero or negative gate voltage; however, positive gate voltage shall not be applied concurrent with negative potential on the anode. Blocking voltages shall not be tested with a constant current source such that the voltage ratings of the devices are exceeded.

### Thermal Characteristics

Rating		Symbol	Value	Unit
Thermal Resistance	Junction-to-Case (AC)	$R_{\theta\text{JC}}$	1.9	$^\circ\text{C}/\text{W}$
	Junction-to-Ambient	$R_{\theta\text{JA}}$	60	
Maximum Lead Temperature for Soldering Purposes, 1/8" from case for 10 seconds		$T_L$	260	$^\circ\text{C}$

### Electrical Characteristics - OFF ( $T_J = 25^\circ\text{C}$ unless otherwise noted ; Electricals apply in both directions)

Characteristic		Symbol	Min	Typ	Max	Unit
Peak Repetitive Blocking Current ( $V_D = V_{\text{DRM}} = V_{\text{RRM}}$ , Gate Open)	$T_J = 25^\circ\text{C}$	$I_{\text{DRM}}^*$ $I_{\text{RRM}}$	-	-	0.005	mA
	$T_J = 125^\circ\text{C}$		-	-	2.0	

### Electrical Characteristics - ON ( $T_J = 25^\circ\text{C}$ unless otherwise noted; Electricals apply in both directions)

Characteristic		Symbol	Min	Typ	Max	Unit
Forward On-State Voltage (Note 2) ( $I_{\text{TM}} = \pm 17$ A Peak)		$V_{\text{TM}}$	-	-	1.55	V
Gate Trigger Current (Continuous dc) ( $V_D = 12$ V, $R_L = 30$ $\Omega$ )	MT2(+), G(+)	$I_{\text{GT}}$	2.5	-	50	mA
	MT2(+), G(-)		2.5	-	50	
	MT2(-), G(-)		2.5	-	50	
Holding Current ( $V_D = 12$ V, Gate Open, Initiating Current = $\pm 150$ mA)		$I_{\text{H}}$	-	-	60	mA
Latching Current ( $V_D = 12$ V, $I_G = 50$ mA)	MT2(+), G(+)	$I_{\text{L}}$	-	-	70	mA
	MT2(+), G(-)		-	-	90	
	MT2(-), G(-)		-	-	70	
Gate Trigger Voltage ( $V_D = 12$ V, $R_L = 30$ $\Omega$ )	MT2(+), G(+)	$V_{\text{GT}}$	0.5	-	1.7	V
	MT2(+), G(-)		0.5	-	1.1	
	MT2(-), G(-)		0.5	-	1.1	
Gate Non-Trigger Voltage ( $T_J = 125^\circ\text{C}$ )	MT2(+), G(+)	$V_{\text{GD}}$	0.2	-	-	V
	MT2(+), G(-)		0.2	-	-	
	MT2(-), G(-)		0.2	-	-	

2. Indicates Pulse Test: Pulse Width  $\leq 2.0$  ms, Duty Cycle  $\leq 2\%$ .

# BTB16-600BW3G, BTB16-700BW3G, BTB16-800BW3G

Surface Mount – 800V

## Dynamic Characteristics

Characteristic	Symbol	Min	Typ	Max	Unit
Rate of Change of Commutating Current, See Figure 10. (Gate Open, $T_J = 125^\circ\text{C}$ , No Snubber)	$(di/dt)_c$	7.5	–	–	A/ms
Critical Rate of Rise of On-State Current ( $T_J = 125^\circ\text{C}$ , $f = 120\text{ Hz}$ , $I_G = 2 \times I_{GT}$ , $tr \leq 100\text{ ns}$ )	$di/dt$	–	–	50	A/ $\mu\text{s}$
Critical Rate of Rise of Off-State Voltage ( $V_D = 0.66 \times V_{DRM}$ , Exponential Waveform, Gate Open, $T_J = 125^\circ\text{C}$ )	$dV/dt$	1500	–	–	V/ $\mu\text{s}$

## Voltage Current Characteristic of SCR

Symbol	Parameter
$V_{DRM}$	Peak Repetitive Forward Off State Voltage
$I_{DRM}$	Peak Forward Blocking Current
$V_{RRM}$	Peak Repetitive Reverse Off State Voltage
$I_{RRM}$	Peak Reverse Blocking Current
$V_{TM}$	Maximum On State Voltage
$I_H$	Holding Current

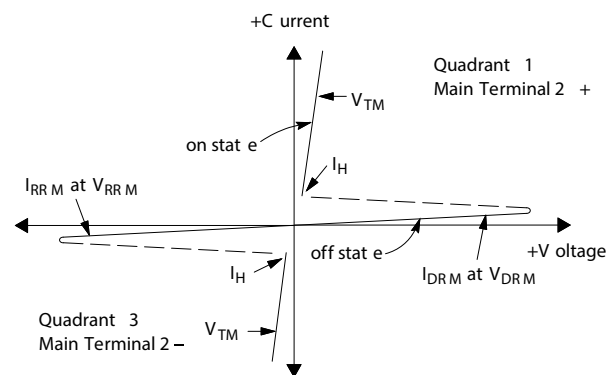

### Quadrant Definitions for a Triac

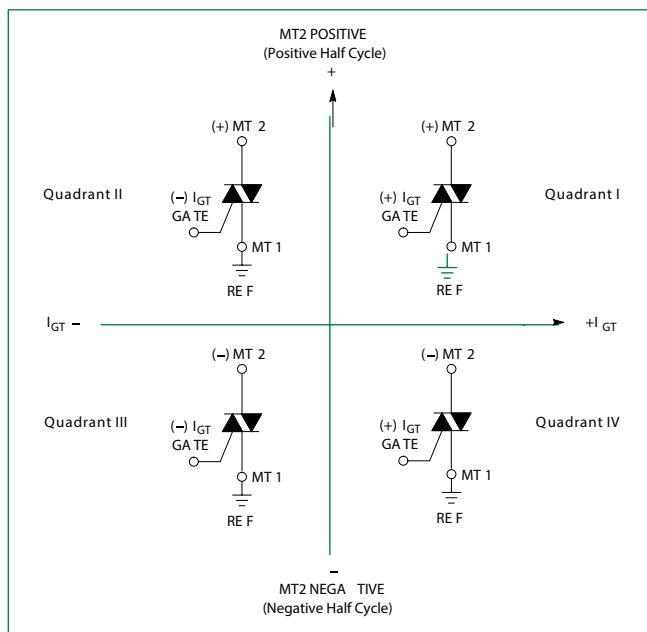

All polarities are referenced to MT1.  
With in-phase signals (using standard AC lines) quadrants I and III are used

# BTB16-600BW3G, BTB16-700BW3G, BTB16-800BW3G

Surface Mount – 800V

**Figure 1. Typical RMS Current Derating**

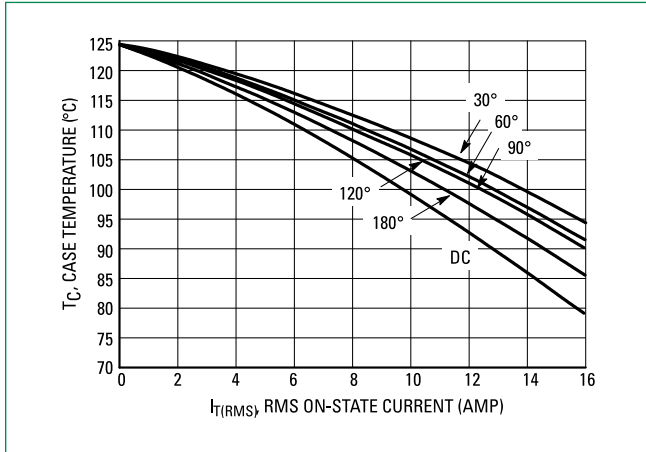

**Figure 2. On-State Power Dissipation**

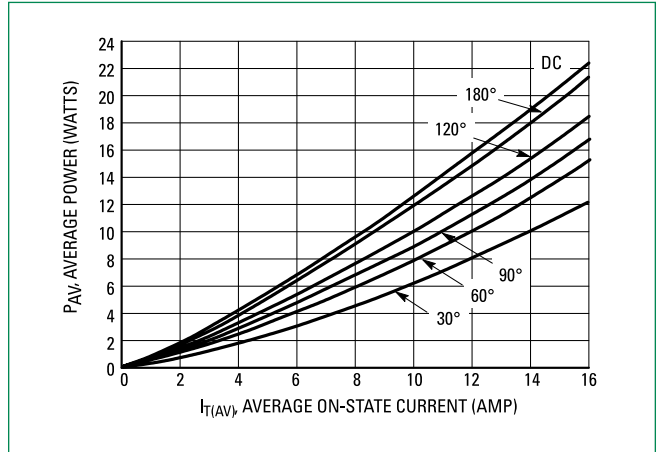

**Figure 3. On-State Characteristics**

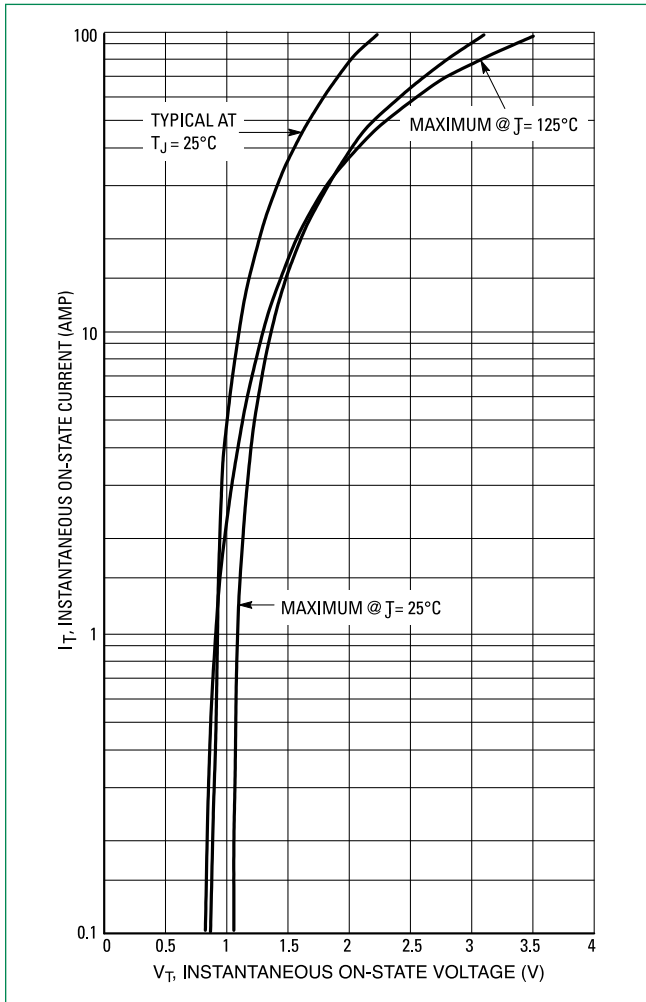

**Figure 4. Thermal Response**

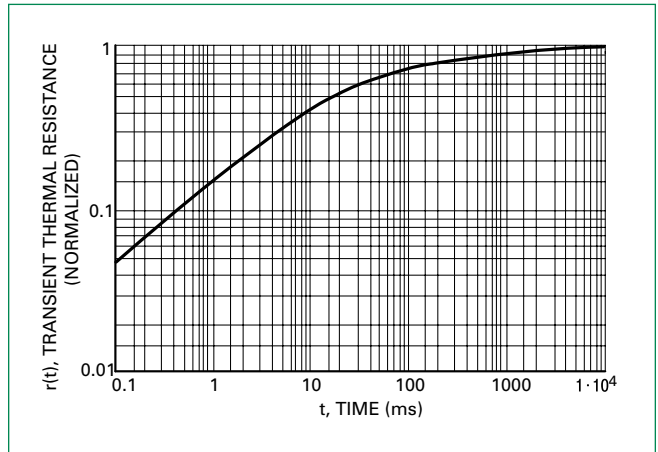

**Figure 5. Typical Hold Current Variation**

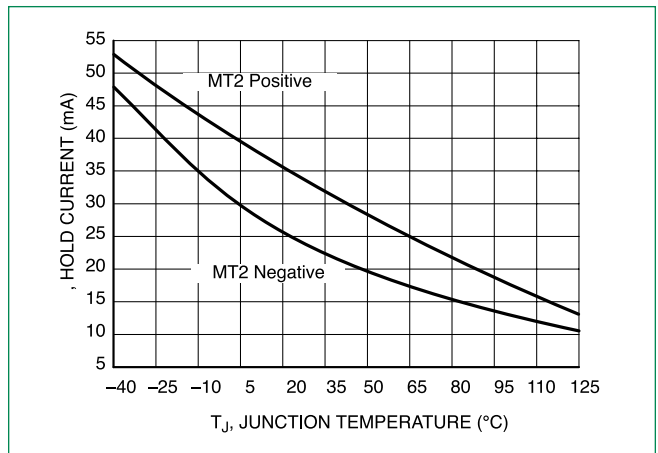

# BTB16-600BW3G, BTB16-700BW3G, BTB16-800BW3G

Surface Mount – 800V

**Figure 6. Typical Gate Trigger Current Variation**

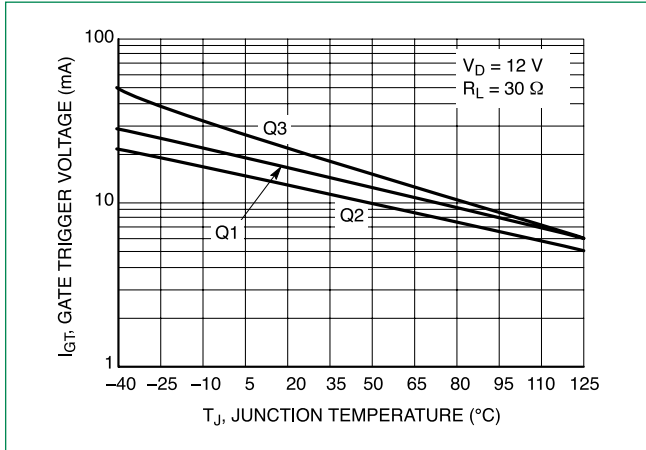

**Figure 7. Typical Gate Trigger Voltage Variation**

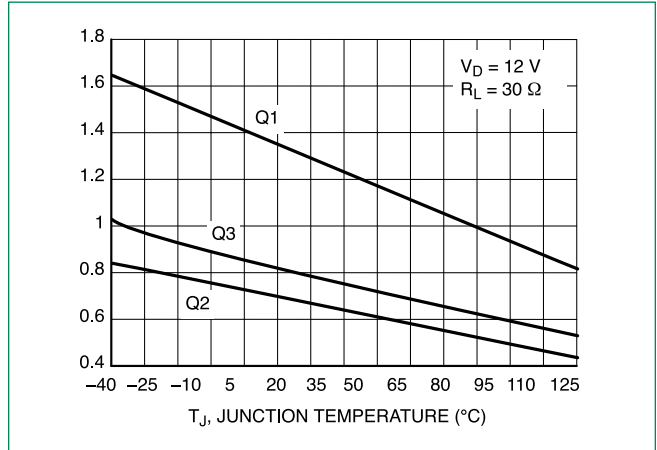

**Figure 8. Simplified Test Circuit to Measure the Critical Rate of Rise of Commutating Current ( $di/dt$ )**

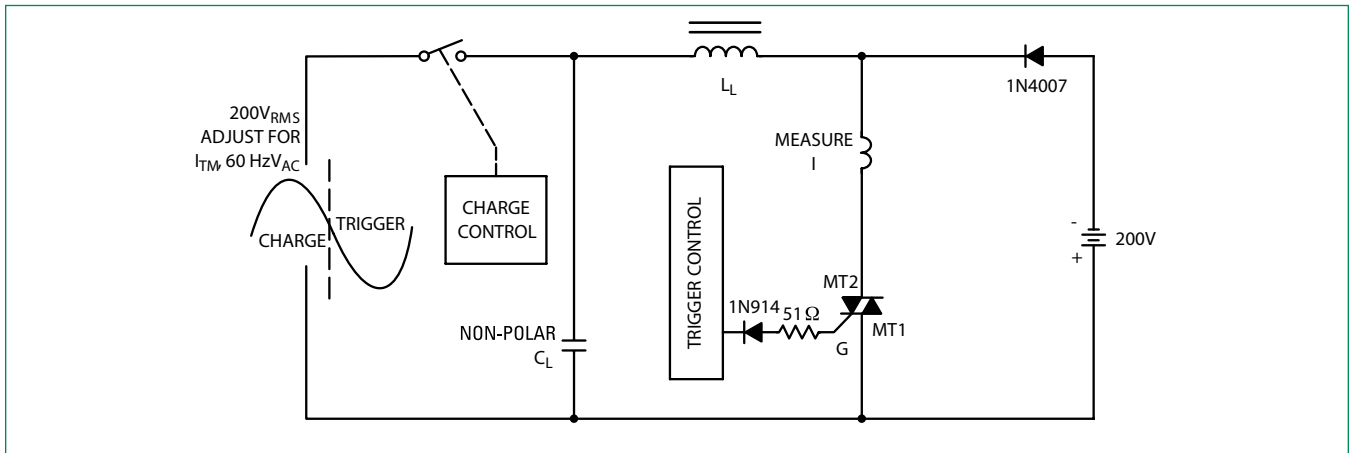

**Note:** Component values are for verification of rated ( $di/dt$ )<sub>c</sub>. See AN1048 for additional information

# BTB16-600BW3G, BTB16-700BW3G, BTB16-800BW3G

Surface Mount – 800V

## Dimensions

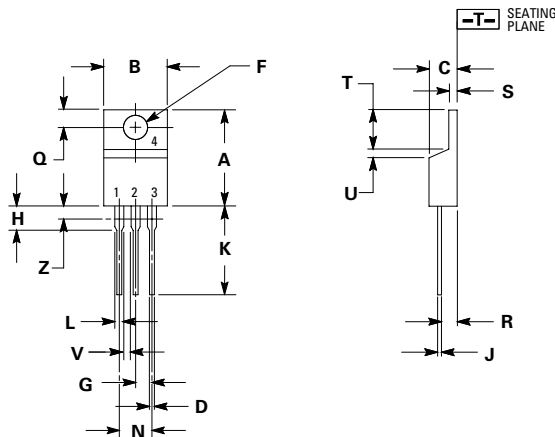

Dim	Inches		Millimeters	
	Min	Max	Min	Max
A	0.590	0.620	14.99	15.75
B	0.380	0.420	9.65	10.67
C	0.178	0.188	4.52	4.78
D	0.025	0.035	0.64	0.89
F	0.142	0.147	3.61	3.73
G	0.095	0.105	2.41	2.67
H	0.110	0.130	2.79	3.30
J	0.018	0.024	0.46	0.61
K	0.540	0.575	13.72	14.61
L	0.060	0.075	1.52	1.91
N	0.195	0.205	4.95	5.21
Q	0.105	0.115	2.67	2.92
R	0.085	0.095	2.16	2.41
S	0.045	0.060	1.14	1.52
T	0.235	0.255	5.97	6.47
U	0.000	0.050	0.00	1.27
V	0.045	-	1.15	-
Z	-	0.080	-	2.04

1. Dimensioning and tolerancing per ansi y14.5m, 1982.
2. Controlling dimension: inch.
3. Dimension z defines a zone where all body and lead irregularities are allowed.

## Part Marking System

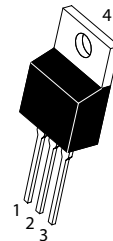

**TO-220AB  
CASE 221A  
STYLE 12**

- x = 6 or 8
- Y = Year
- M = Month
- A = Assembly Site
- XX = Lot Serial Code
- G = Pb-Free Package



Pin Assignment	
1	Main Terminal 1
2	Main Terminal 2
3	Gate
4	Main Terminal 2

## Ordering Information

Device	Package	Shipping
BTB16-600BW3G	TO-220AB (Pb-Free)	1000 Units / Box
BTB16-700BW3G	TO-220AB (Pb-Free)	1000 Units / Box
BTB16-800BW3G	TO-220AB (Pb-Free)	1000 Units / Box

**Disclaimer Notice** - Information furnished is believed to be accurate and reliable. However, users should independently evaluate the suitability of and test each product selected for their own applications. Littelfuse products are not designed for, and may not be used in, all applications. Read complete Disclaimer Notice at <http://www.littelfuse.com/disclaimer-electronics>.