

MAC212A8, MAC212A10

Triacs – 400V - 800V

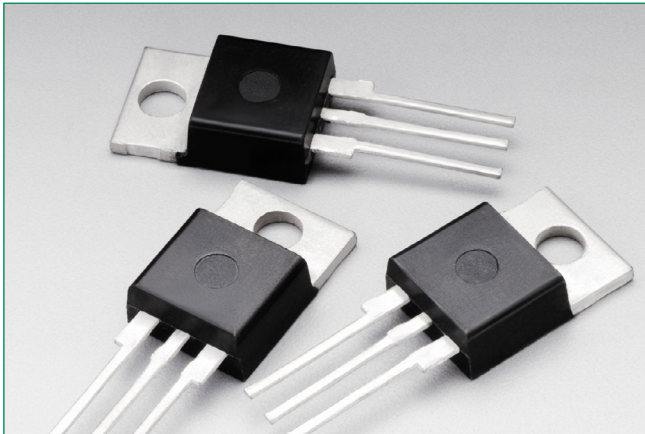

Description

Designed primarily for full-wave AC control applications, such as light dimmers, motor controls, heating controls and power supplies; or wherever full-wave silicon gate controlled solid-state devices are needed. Triac type thyristors switch from a blocking to a conducting state for either polarity of applied main terminal voltage with positive or negative gate triggering.

Features & Benefits

- Blocking Voltage to 800 Volts
- All Diffused and Glass Passivated Junctions for Greater Parameter Uniformity and Stability
- Small, Rugged, Thermowatt Construction for Low Thermal Resistance, High Heat Dissipation and Durability
- Gate Triggering Guaranteed in Four Modes (Quadrants)
- Pb-Free Packages are Available

Additional Information



Resources



Accessories



Samples

Functional Diagram

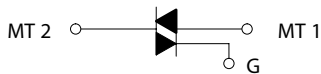

Pin Out

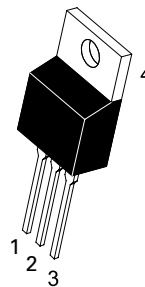

**TO-220AB
CASE 221A
STYLE 4**

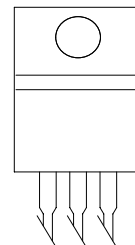

MAC212A8, MAC212A10

Triacs – 400V - 800V

Maximum Ratings ($T_J = 25^\circ\text{C}$ unless otherwise noted)

Rating	Symbol	Value	Unit
Peak Repetitive Off-State Voltage (Note 1) (– 40 to 125°C, Sine Wave, 50 to 60 Hz, Gate Open)	MAC212A8	600 800	V
	MAC212A10	800	
On-State RMS Current (Full Cycle Sine Wave, 50 to 60 Hz, $T_C = +85^\circ\text{C}$)	I_T (RMS)	12	A
Peak Non-Repetitive Surge Current (One Full Cycle Sine Wave, 60 Hz, $T_C = +25^\circ\text{C}$) Preceded and followed by rated current	I_{TSM}	100	A
Circuit Fusing Considerations (t = 8.3 ms)	I^2t	40	A ² sec
Peak Gate Power ($T_C = +85^\circ\text{C}$, Pulse Width = 10 μs)	P_{GM}	20	W
Average Gate Power (t = 8.3 ms, $T_C = +85^\circ\text{C}$)	$P_{G(AV)}$	0.35	W
Peak Gate Current ($T_C = +85^\circ\text{C}$, Pulse Width = 10 μs)	I_{GM}	2.0	A
Operating Junction Temperature Range	T_J	-40 to +125	°C
Storage Temperature Range	T_{stg}	-40 to +150	°C

Maximum ratings are those values beyond which device damage can occur. Maximum ratings applied to the device are individual stress limit values (not normal operating conditions) and are not valid simultaneously. If these limits are exceeded, device functional operation is not implied, damage may occur and reliability may be affected.

1. V_{DRM} and V_{RRM} for all types can be applied on a continuous basis. Ratings apply for zero or negative gate voltage; however, positive gate voltage shall not be applied concurrent with negative potential on the anode. Blocking voltages shall not be tested with a constant current source such that the voltage ratings of the devices are exceeded.

Thermal Characteristics

Rating	Symbol	Value	Unit
Thermal Resistance, Junction-to-Case (AC) Junction-to-Ambient	$R_{\theta JC}$	2.0	°C/W
	$R_{\theta JA}$	62.5	
Maximum Lead Temperature for Soldering Purposes, 1/8" from case for 10 seconds	T_L	260	°C

Electrical Characteristics - OFF ($T_J = 25^\circ\text{C}$ unless otherwise noted ; Electricals apply in both directions)

Characteristic	Symbol	Min	Typ	Max	Unit	
Peak Repetitive Blocking Current ($V_D = V_{DRM} = V_{RRM}$; Gate Open)	I_{DRM} I_{RRM}	$T_J = 25^\circ\text{C}$	-	-	10	μA
		$T_J = 125^\circ\text{C}$	-	-	2.0	mA

Electrical Characteristics - ON ($T_J = 25^\circ\text{C}$ unless otherwise noted; Electricals apply in both directions)

Characteristic	Symbol	Min	Typ	Max	Unit	
Peak On-State Voltage ($I_{TM} = 17$ A Peak; Pulse Width = 1 to 2 ms, Duty Cycle $\leq 2\%$)	V_{TM}	-	1.3	1.75	V	
Gate Trigger Current (Continuous dc) (Main Terminal Voltage = 12 Vdc, $R_L = 100 \Omega$)	I_{GT}	MT2(+), G(+)	-	12	50	mA
		MT2(+), G(-)	-	12	50	
		MT2(-), G(-)	-	20	50	
		MT2(-), G(+)	-	35	75	
Gate Trigger Voltage (Continuous dc) (Main Terminal Voltage = 12 Vdc, $R_L = 100 \Omega$)	V_{GT}	MT2(+), G(+)	-	0.9	2.0	V
		MT2(+), G(-)	-	0.9	2.0	
		MT2(-), G(-)	-	1.1	2.0	
		MT2(-), G(+)	-	1.4	2.5	
Gate Non-Trigger Voltage (Continuous dc) Main Terminal Voltage = 12 V, $R_L = 100 \Omega$, $T_J = +125^\circ\text{C}$) All Four Quadrants	V_{GD}	0.2	-	-	V	
Holding Current (Main Terminal Voltage = 12 Vdc, Gate Open, Initiating Current = ± 200 mA)	I_H	-	6.0	50	mA	
Turn-On Time (Rated V_{DRM} , $I_{TM} = 17$ A) ($I_{GT} = 120$ mA, Rise Time = 0.1 μs , Pulse Width = 2 μs)	t_{gt}	-	1.5	-	μs	

MAC212A8, MAC212A10

Triacs – 400V - 800V

Dynamic Characteristics

Characteristic	Symbol	Min	Typ	Max	Unit
Critical Rate of Rise of Commutation Voltage ($V_D = \text{Rated } V_{DRM}$, $I_{TM} = 17 \text{ A}$, Commutating $di/dt = 6.1 \text{ A/ms}$, Gate Unenergized, $T_c = +85^\circ\text{C}$)	$di/dt_{(c)}$	–	5.0	–	V/ μs
Critical Rate of Rise of Off-State Voltage ($V_D = \text{Rated } V_{DRM}$, Exponential Waveform, Gate Open, $T_c = +85^\circ\text{C}$)	dv/dt	–	100	–	V/ μs

Voltage Current Characteristic of SCR

Symbol	Parameter
V_{DRM}	Peak Repetitive Forward Off State Voltage
I_{DRM}	Peak Forward Blocking Current
V_{RRM}	Peak Repetitive Reverse Off State Voltage
I_{RRM}	Peak Reverse Blocking Current
V_{TM}	Maximum On State Voltage
I_H	Holding Current

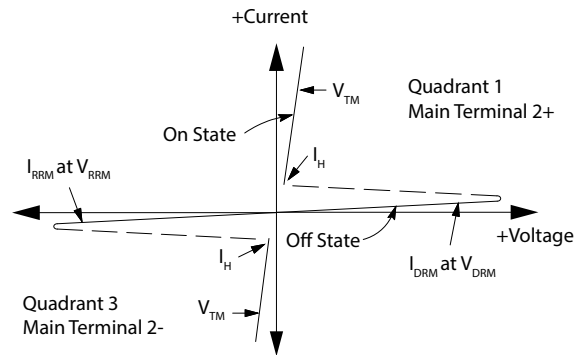

Quadrant Definitions for a Triac

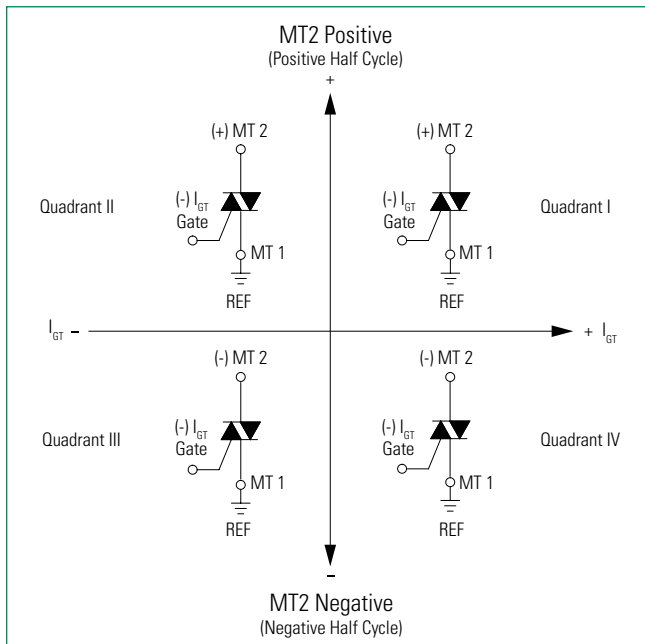

All Polarities are referenced to MT1.
With in-phase signals (using standard AC lines) quadrants I and III are used

MAC212A8, MAC212A10

Triacs – 400V - 800V

Figure 1.
Current Derating

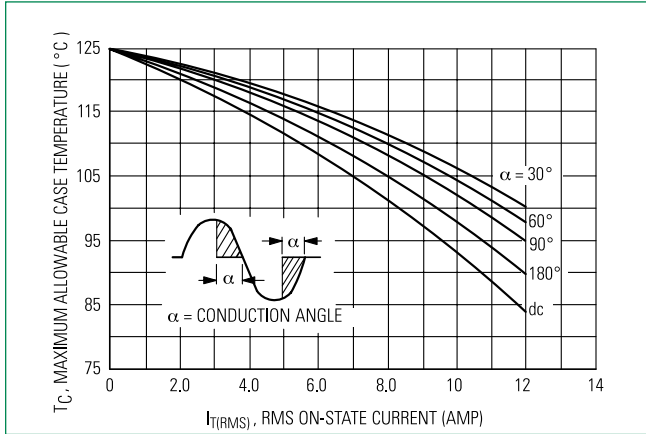

Figure 2.
Power Dissipation

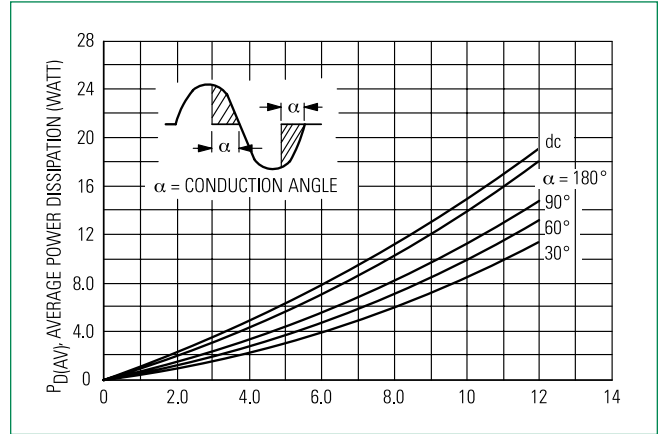

Figure 3.
Maximum On-State Characteristics

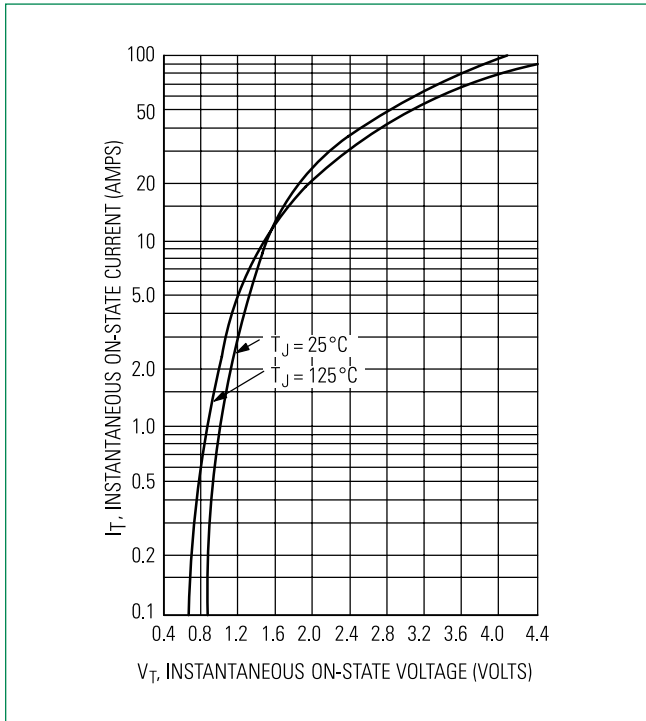

Figure 4.
Maximum Non-Repetitive Surge Current

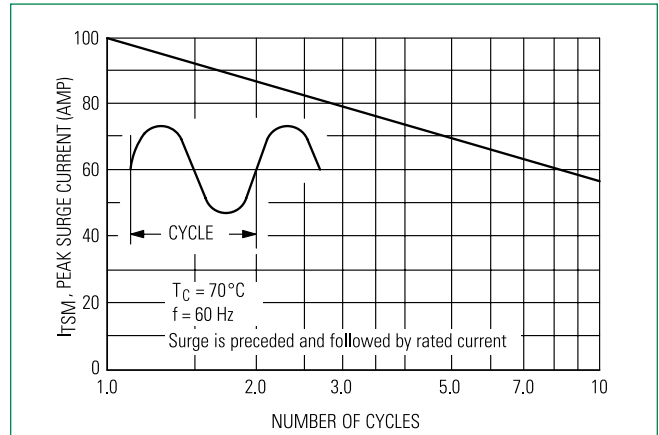
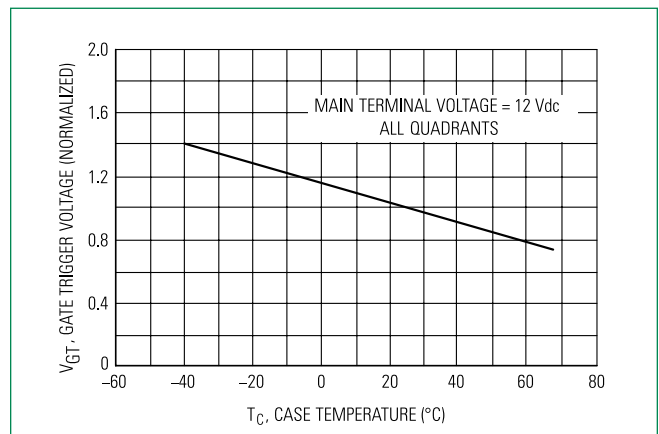

Figure 5.
Typical Gate Trigger Voltage



MAC212A8, MAC212A10

Triacs – 400V - 800V

Figure 6.
Typical Gate Trigger Current

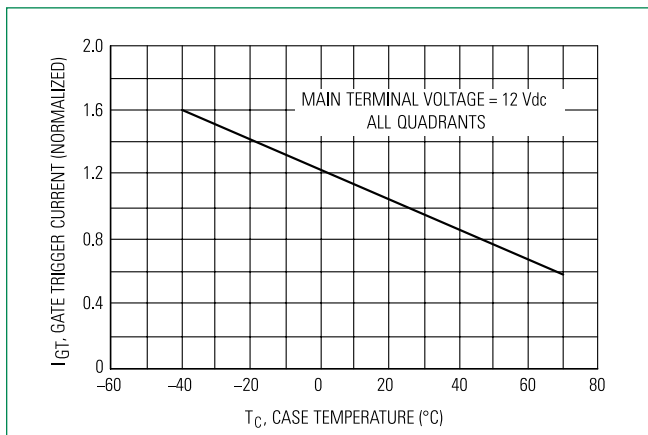

Figure 7.
Typical Holding Current

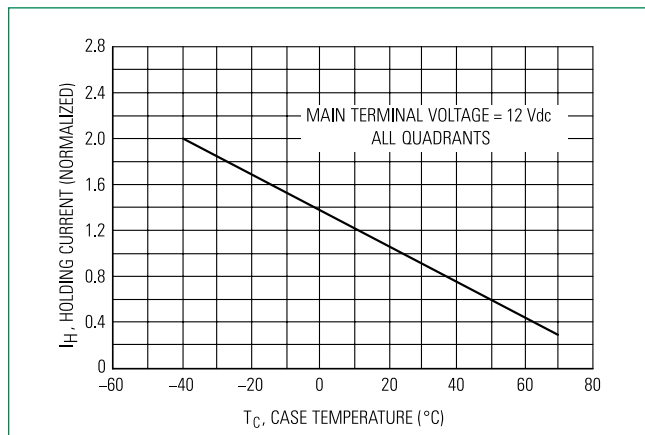
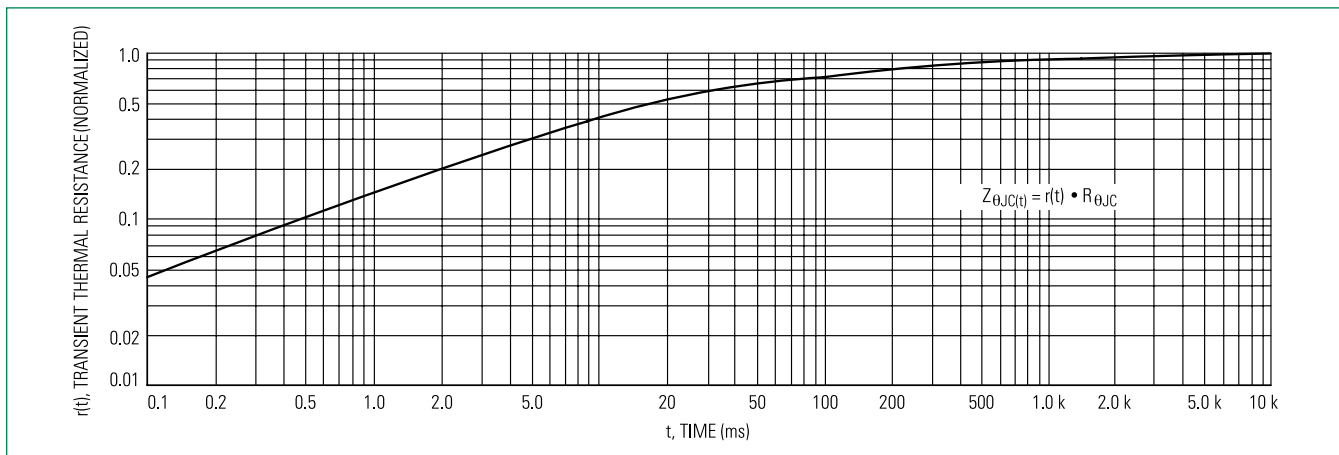

Figure 8.
Thermal Response



MAC212A8, MAC212A10

Triacs – 400V - 800V

Dimensions

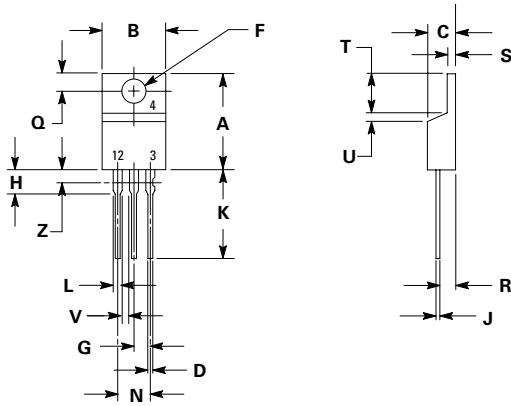

Part Marking System

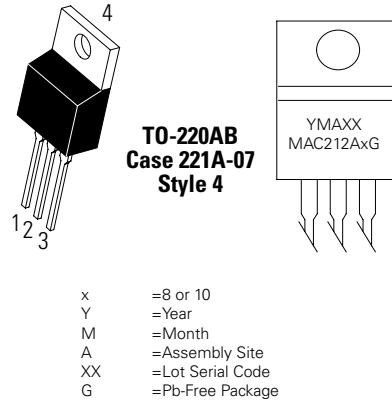

Dim	Inches		Millimeters	
	Min	Max	Min	Max
A	0.590	0.620	14.99	15.75
B	0.380	0.420	9.65	10.67
C	0.178	0.188	4.52	4.78
D	0.025	0.035	0.64	0.89
F	0.142	0.147	3.61	3.73
G	0.095	0.105	2.41	2.67
H	0.110	0.130	2.79	3.30
J	0.018	0.024	0.46	0.61
K	0.540	0.575	13.72	14.61
L	0.060	0.075	1.52	1.91
N	0.195	0.205	4.95	5.21
Q	0.105	0.115	2.67	2.92
R	0.085	0.095	2.16	2.41
S	0.045	0.060	1.14	1.52
T	0.235	0.255	5.97	6.47
U	0.000	0.050	0.00	1.27
V	0.045	—	1.15	—
Z	—	0.080	—	2.04

1. Dimensioning and tolerancing per ansi y14.5m, 1982.
2. Controlling dimension: inch.
3. Dimension z defines a zone where all body and lead irregularities are allowed.

Pin Assignment	
1	Cathode
2	Anode
3	Gate
4	Anode

Ordering Information

Device	Package	Shipping
MAC212A8	TO-220AB	1000 Units/ Box
MAC212A8G	TO-220AB (Pb-Free)	
MAC212A10	TO-220AB	
MAC212A10G	TO-220AB (Pb-Free)	

Disclaimer Notice - Information furnished is believed to be accurate and reliable. However, users should independently evaluate the suitability of and test each product selected for their own applications. Littelfuse products are not designed for, and may not be used in, all applications. Read complete Disclaimer Notice at <http://www.littelfuse.com/disclaimer-electronics>.