

MCR106-6, MCR106-8

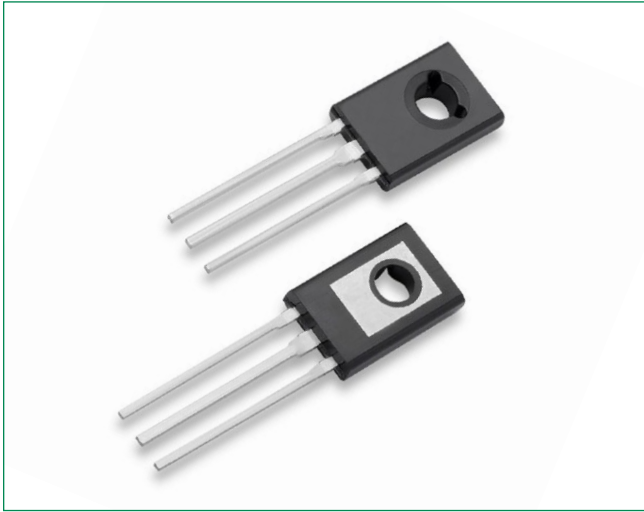

Description

PNPN devices designed for high volume consumer applications such as temperature, light and speed control; process and remote control, and warning systems where reliability of operation is important.

Features

- Glass-Passivated Surface for Reliability and Uniformity
- Power Rated at Economical Prices
- Practical Level Triggering and Holding Characteristics
- Flat, Rugged, Thermopad Construction for Low Thermal Resistance, High Heat Dissipation and Durability
- Lead-free Packages are Available

Pin Out

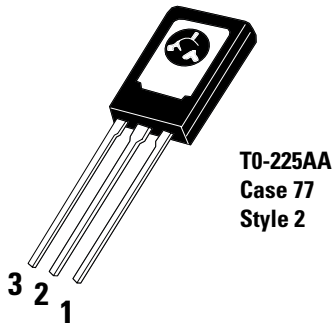

Functional Diagram



Additional Information



Datasheet



Resources



Samples

Maximum Ratings ($T_J = 25^\circ\text{C}$ unless otherwise noted)

Rating	Symbol	Value	Unit
Peak Repetitive Off-State Voltage (Note 1) (– 40 to 110°C, Sine Wave, 50 to 60 Hz, $R_{GK}=1\text{Kohm}$)	V_{DRM} V_{RRM}	400 600	V
On-State RMS Current (180° Conduction Angles; $T_C = 93^\circ\text{C}$)	$I_{TM(RMS)}$	4.0	A
Peak Non-Repetitive Surge Current (1/2 Cycle, Sine Wave 60 Hz, $T_J = 110^\circ\text{C}$)	I_{TSM}	25	A
Average On-State Current (180° Conduction Angles; $T_C = 93^\circ\text{C}$)	$I_{T(AV)}$	2.55	A
Circuit Fusing Consideration ($t = 8.3$ ms)	I^2t	2.6	A ² s
Forward Peak Gate Power ($T_C = 93^\circ\text{C}$, Pulse Width ≤ 1.0 μs)	P_{GM}	0.5	W
Forward Average Gate Power, ($T_C = 93^\circ\text{C}$, $t = 8.3$ ms)	$P_{G(AV)}$	0.1	W
Forward Peak Gate Current, ($T_C = 93^\circ\text{C}$, Pulse Width ≤ 1.0 μs)	I_{GM}	0.2	A
Peak Reverse Gate Voltage, ($T_C = 93^\circ\text{C}$, Pulse Width ≤ 1.0 μs)	V_{RGM}	6.0	V
Operating Junction Temperature Range	T_J	-40 to +110	°C
Storage Temperature Range	T_{stg}	-40 to +150	°C
Mounting Torque	–	6.0	in. lb.

Stresses exceeding those listed in the Maximum Ratings table may damage the device. If any of these limits are exceeded, device functionality should not be assumed, damage may occur and reliability may be affected.

- V_{DRM} and V_{RRM} for all types can be applied on a continuous basis. Ratings apply for zero or negative gate voltage; however, positive gate voltage shall not be applied concurrent with negative potential on the anode. Blocking voltages shall not be tested with a constant current source such that the voltage ratings of the devices are exceeded.
- Torque rating applies with use of compression washer (B52200-F006 or equivalent). Mounting torque in excess of 6 in. lb. does not appreciably lower case-to-sink thermal resistance. Anode lead and heatsink contact pad are common. (See AN209B). For soldering purposes (either terminal connection or device mounting), soldering temperatures shall not exceed +200°C. For optimum results, an activated flux (oxide removing) is recommended.

Thermal Characteristics

Rating	Symbol	Value	Unit
Thermal Resistance, Junction-to-Case (AC) Junction-to-Ambient	$R_{\theta JC}$ $R_{\theta JA}$	3.0 75	°C/W
Maximum Lead Temperature for Soldering Purposes, 1/8" from case for 10 seconds	T_L	260	°C

Electrical Characteristics - OFF ($T_J = 25^\circ\text{C}$ unless otherwise noted)

Characteristic	Symbol	Min	Typ	Max	Unit
Peak Repetitive Forward or Reverse Blocking Current ($V_{AK} = \text{Rated } V_{DRM}$ and V_{RRM} ; $R_{GK}=1\text{Kohm}$)	I_{DRM} I_{RRM}	-	-	10	μA
		-	-	200	

Electrical Characteristics - ON ($T_J = 25^\circ\text{C}$ unless otherwise noted)

Characteristic	Symbol	Min	Typ	Max	Unit	
Peak Forward On-State Voltage (Note 3) ($I_{TM} = 4$ A Peak)	V_{TM}	–	–	2.0	V	
Gate Trigger Current (Continuous DC) (Note 4)	I_{GT}	$(V_{AK} = 7\text{Vdc}; R_L = 100 \Omega)$	–	–	200	μA
		$(T_C = -40^\circ\text{C})$	–	–	500	
Gate Trigger Voltage (Continuous DC) (Note 4) ($V_{AK} = 12\text{V}; R_L = 100 \Omega, T_J = 110^\circ\text{C}$)	V_{GT}	–	–	1.0	V	
Gate Trigger Non-Trigger Voltage (Note 4) ($V_{AK} = 12\text{VDC}; R_L = 100 \Omega$)	V_{GD}	0.2	–	–	V	
Holding Current ($V_{AK} = 7\text{V}$, Initiating Current = 200 mA, $R_{GK} = 1\text{k}\Omega$)	I_H	–	–	5.0	mA	

Dynamic Characteristics

Characteristic	Symbol	Min	Typ	Max	Unit
Critical Rate of Rise of Off-State Voltage ($R_{GK} = 1\text{ k}\Omega$, $T_J = 110^\circ\text{C}$)	dv/dt	-	10	-	V/ μs
Critical Rate of Rise of On-State Current ($I_G = 150\text{ A}$, $T_J = 125^\circ\text{C}$)	di/dt	-	-	75	A/ μs

- Pulse Test: Pulse Width $\leq 1.0\text{ ms}$, Duty Cycle $\leq 1\%$.
- R_{GK} current is not included in measurement.

Voltage Current Characteristic of SCR

Symbol	Parameter
V_{DRM}	Peak Repetitive Forward Off State Voltage
I_{DRM}	Peak Forward Blocking Current
V_{RRM}	Peak Repetitive Reverse Off State Voltage
I_{RRM}	Peak Reverse Blocking Current
V_{TM}	Maximum On State Voltage
I_H	Holding Current

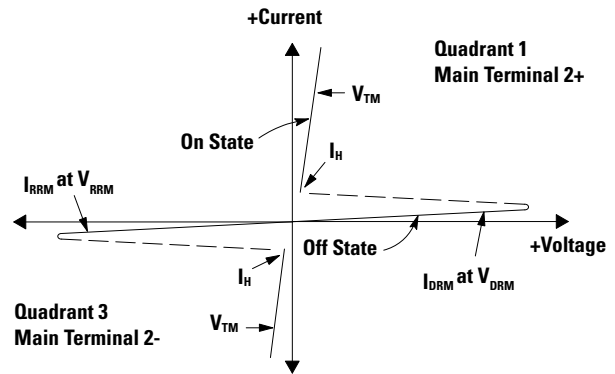

Figure 1. Average Current Derating

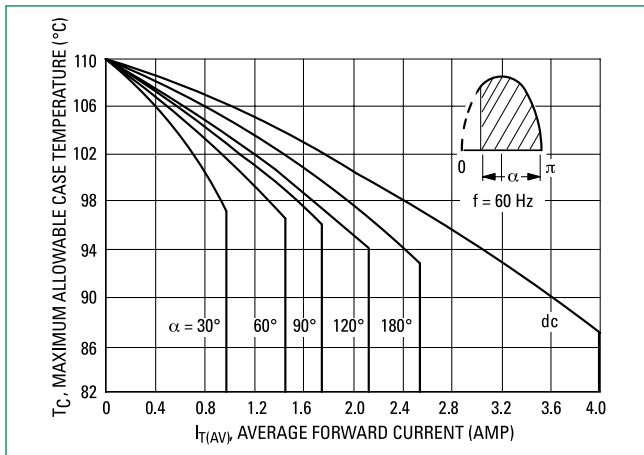
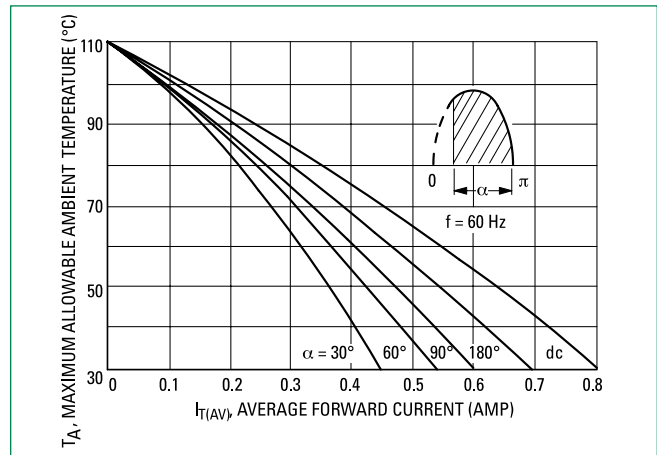
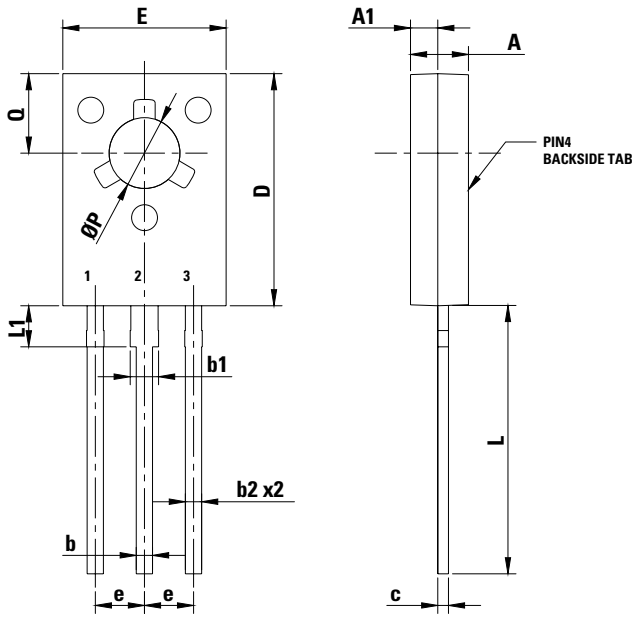

Figure 2. On-State Power Dissipation



Dimensions



Dim	Inches		Millimeters	
	Min	Max	Min	Max
A	0.102	0.110	2.60	2.80
A1	0.047	0.055	1.20	1.40
b	0.028	0.034	0.70	0.86
b2	0.028	0.034	0.70	0.86
c	0.019	0.022	0.49	0.57
D	0.417	0.449	10.60	11.40
E	0.291	0.323	7.40	8.20
e	0.090 TYP		2.29 TYP	
L	0.551	0.630	14.00	16.00
L1	0.091	0.106	2.30	2.70
P	0.118	0.134	3.00	3.40
Q	0.142	0.157	3.60	4.00
b1	0.047	0.055	1.2	1.4

1. Dimensioning and Tolerancing Per ANSI Y14.5M, 1982.
2. Controlling Dimension: Inch.
3. 077-01 Thru -08 Obsolete, New Standard 077-09.

Part Marking System

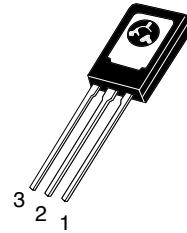

TO-225AA
CASE 77
STYLE 2

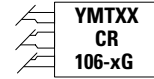

Y- Year
M- Month
T- Assembly Location
XX- Sequence Number
CR106-x- Device Code x=6 or 8
G- Pb-Free Package

Pin Assignment

1	Cathode
2	Anode
3	Gate
4	Anode

Ordering Information

Device	Package	Shipping
MCR106-6	TO-225AA	2500 / Box
MCR106-6G	TO-225AA (Pb-Free)	
MCR106-8	TO-225AA	
MCR106-8G	TO-225AA (Pb-Free)	