

# MCR8NG

Silicon Controlled Rectifiers — 600V - 800V

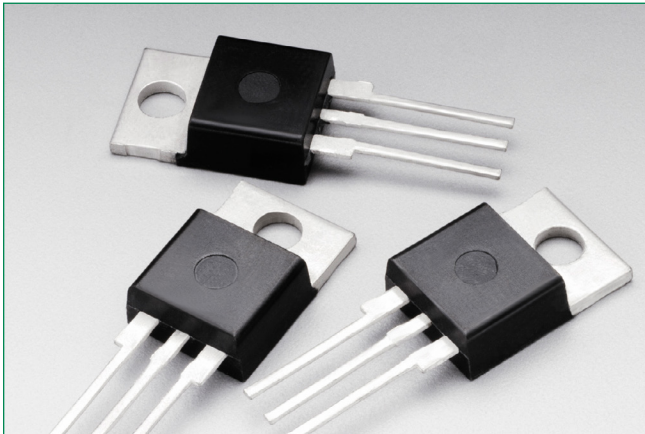

## Description

Designed primarily for half-wave ac control applications, such as motor controls, heating controls, and power supplies; or wherever half-wave, silicon gate-controlled devices are needed.

## Features

- Blocking Voltage of 600 thru 800 Volts
- On-State Current Rating of 8 Amperes RMS at 80°C
- High Surge Current Capability – 80 Amperes
- Rugged, Economical TO-220AB Package
- Glass Passivated Junctions for Reliability and Uniformity
- Minimum and Maximum Values of IGT, VGT and IH Specified for Ease of Design
- High Immunity to dv/dt – 100 V/μsec Minimum at 125°C
- These are Pb-Free Devices

## Additional Information



Resources



Accessories



Samples

## Functional Diagram

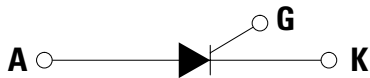

## Pin Out

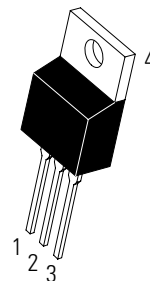

**TO-220AB  
Case 221A  
Style 4**

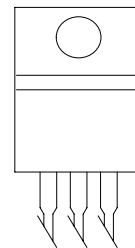

**MCR8NG****Silicon Controlled Rectifiers — 600V - 800V****Maximum Ratings** ( $T_J = 25^\circ\text{C}$  unless otherwise noted)

Rating		Symbol	Value	Unit
Peak Repetitive Off-State Voltage (Note 1) (- 40 to 125°C, Sine Wave, 50 to 60 Hz, Gate Open)	MCR8MG	$V_{DRM}^*$	600	V
	MCR8NG	$V_{RRM}$	800	V
On-State RMS Current (180° Conduction Angles; $T_C = 80^\circ\text{C}$ )		$I_T (RMS)$	8.0	A
Peak Non-Repetitive Surge Current (One Full Cycle, 60 Hz, $T_C = 125^\circ\text{C}$ )		$I_{TSM}$	80	A
Circuit Fusing Consideration (t = 8.3 ms)		$I^2t$	26.5	A <sup>2</sup> sec
Forward Peak Gate Power (Pulse Width $\leq 1.0 \mu\text{s}$ , $T_C = 80^\circ\text{C}$ )		$P_{GM}$	5.0	W
Forward Average Gate Power (t = 8.3 ms, $T_C = 80^\circ\text{C}$ )		$P_{GM (AV)}$	0.5	W
Forward Peak Gate Current (Pulse Width $\leq 1.0 \mu\text{s}$ , $T_C = 80^\circ\text{C}$ )		$I_{GM}$	2.0	A
Operating Junction Temperature Range		$T_J$	-40 to +125	°C
Storage Temperature Range		$T_{stg}$	-40 to +150	°C

Stresses exceeding Maximum Ratings may damage the device. Maximum Ratings are stress ratings only. Functional operation above the Recommended Operating Conditions is not implied. Extended exposure to stresses above the Recommended Operating Conditions may affect device reliability.

1.  $V_{DRM}^*$  and  $V_{RRM}$  for all types can be applied on a continuous basis. Ratings apply for zero or negative gate voltage; however, positive gate voltage shall not be applied concurrent with negative potential on the anode. Blocking voltages shall not be tested with a constant current source such that the voltage ratings of the devices are exceeded.

**Thermal Characteristics**

Rating		Symbol	Value	Unit
Thermal Resistance	Junction-to-Case (AC)	$R_{\theta JC}$	2.2	°C/W
	Junction-to-Ambient	$R_{\theta JA}$	62.5	°C/W
Maximum Lead Temperature for Soldering Purposes, 1/8" from case for 10 seconds		$T_L$	260	°C

**Electrical Characteristics - OFF** ( $T_C = 25^\circ\text{C}$  unless otherwise noted)

Characteristic	Symbol	Min	Typ	Max	Unit
†Peak Repetitive Blocking Current ( $V_{AK} = V_{DRM} = V_{RRM}^*$ ; Gate Open)	$T_J = 25^\circ\text{C}$	-	-	0.01	mA
	$T_J = 125^\circ\text{C}$	-	-	2.0	mA

**Electrical Characteristics - ON** ( $T_J = 25^\circ\text{C}$  unless otherwise noted; Electricals apply in both directions)

Characteristic	Symbol	Min	Typ	Max	Unit
Peak On-State Voltage ( $I_{TM} = 16 \text{ A}$ )	$V_{TM}$	-	-	1.8	V
Gate Trigger Current (Continuous dc) ( $V_D = 12 \text{ V}$ , $R_L = 100 \Omega$ )	$I_{GT}$	2.0	7.0	15	mA
Gate Trigger Voltage (Continuous dc) ( $V_D = 12 \text{ V}$ , $R_L = 100 \Omega$ )	$V_{GT}$	0.5	0.65	1.0	V
Gate Non-Trigger Voltage ( $V_D = 12 \text{ V}$ , $T_J = 125^\circ\text{C}$ , $R_L = 100 \Omega$ )	$V_{GD}$	0.2	-	-	V
Holding Current ( $V_D = 12 \text{ V}$ , Gate Open, Initiating Current = 200 mA)	$I_H$	4.0	17	30	mA
Latch Current ( $V_D = 12 \text{ V}$ , $I_G = 15 \text{ mA}$ )	$I_L$	6.0	20	40	mA

# MCR8NG

## Silicon Controlled Rectifiers — 600V - 800V

### Dynamic Characteristics

Characteristic	Symbol	Min	Typ	Max	Unit
Critical Rate of Rise of Off-State Voltage ( $V_D = \text{Rated } V_{DRM}$ , Exponential Waveform, Gate Open, $T_J = 125^\circ\text{C}$ )	dv/dt	100	250	—	V/ $\mu\text{s}$
Critical Rate of Rise of On-State Current (IPK = 50 A, Pw = 40 $\mu\text{sec}$ , diG/dt = 1 A/ $\mu\text{sec}$ , Igt = 50 mA)	di/dt	—	—	50	A/ms

Product parametric performance is indicated in the Electrical Characteristics for the listed test conditions, unless otherwise noted. Product performance may not be indicated by the Electrical Characteristics if operated under different conditions.

2. Indicates Pulse Test: Pulse Width  $\leq 2.0$  ms, Duty Cycle  $\leq 2\%$ .

### Voltage Current Characteristic of SCR

Symbol	Parameter
$V_{DRM}$	Peak Repetitive Forward Off State Voltage
$I_{DRM}$	Peak Forward Blocking Current
$V_{RRM}$	Peak Repetitive Reverse Off State Voltage
$I_{RRM}$	Peak Reverse Blocking Current
$V_{TM}$	Maximum On State Voltage
$I_H$	Holding Current

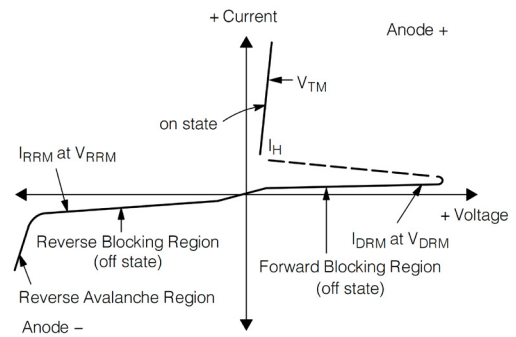

**Figure 1.**  
Typical RMS Current Derating

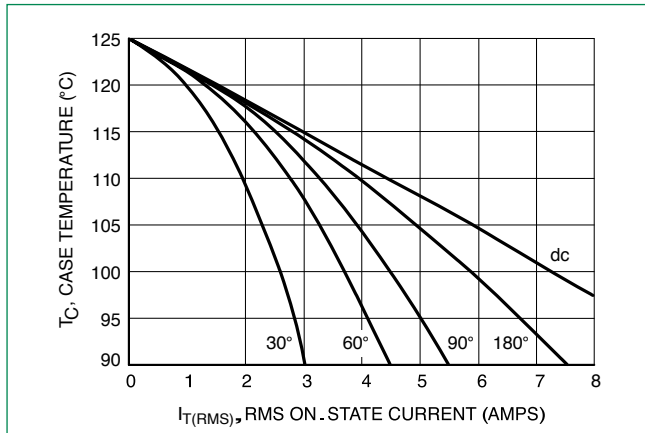

**Figure 2.**  
On-State Power Dissipation

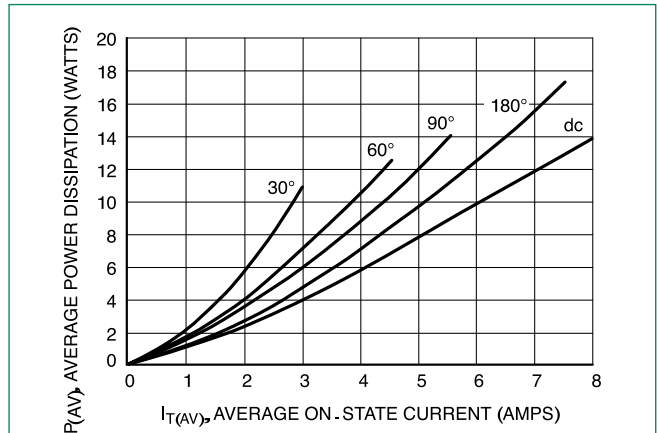

# MCR8NG

## Silicon Controlled Rectifiers — 600V - 800V

**Figure 3.**  
Typical On-State Characteristics

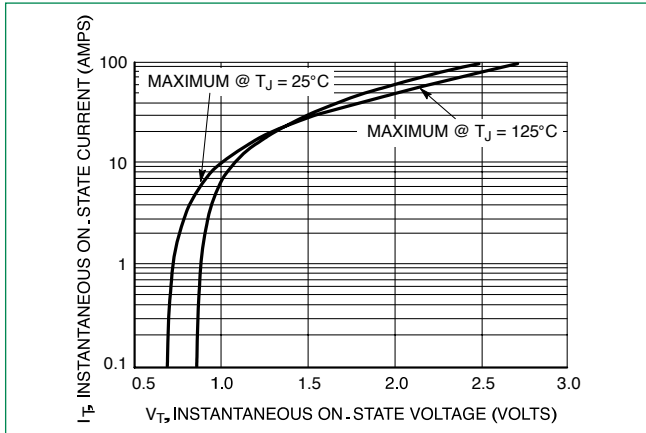

**Figure 4.**  
Typical Gate Trigger Current vs Junction Temperature

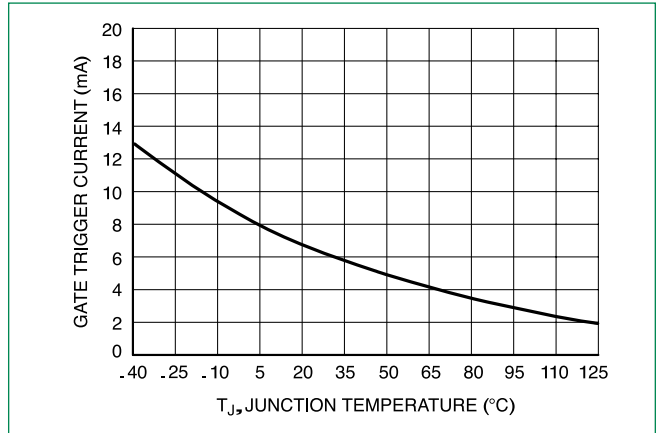

**Figure 5.**  
Typical Holding Current vs Junction Temperature

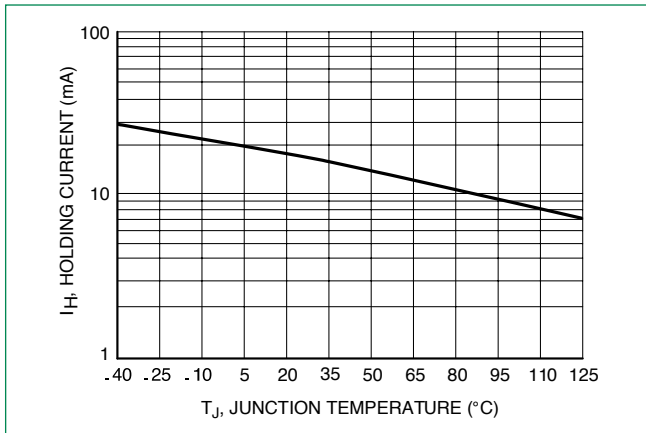

**Figure 6.**  
Typical Gate Trigger Voltage vs Junction Temperature

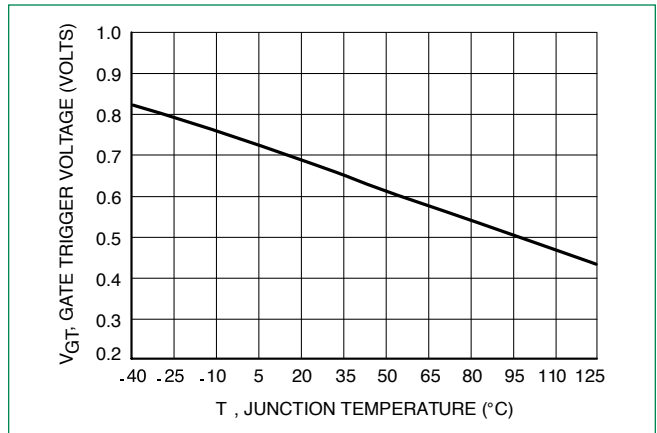

**Figure 7.**  
Typical Latching Current vs Junction Temperature

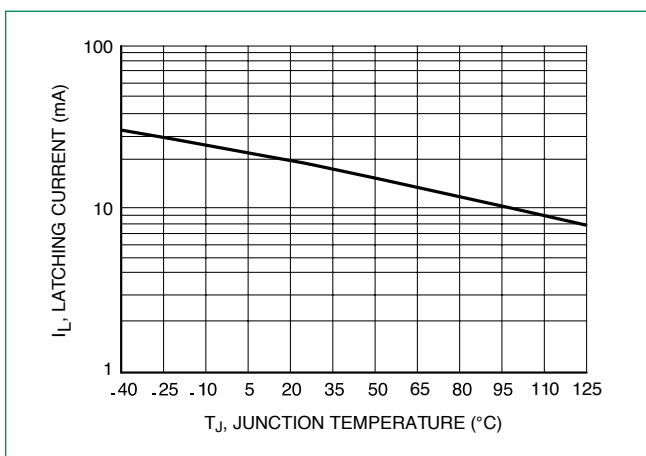

# MCR8NG

## Silicon Controlled Rectifiers — 600V - 800V

### Dimensions

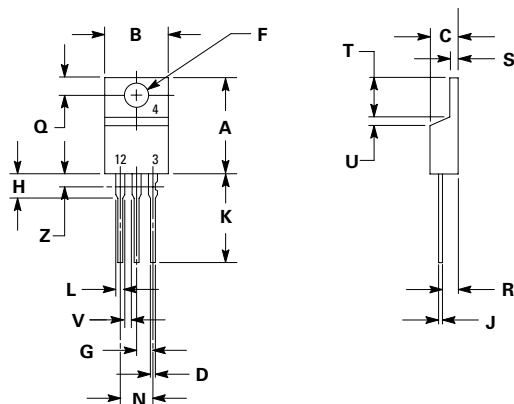

### Part Marking System

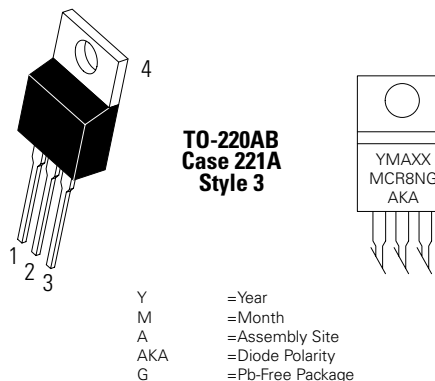

Dim	Inches		Millimeters	
	Min	Max	Min	Max
A	0.590	0.620	14.99	15.75
B	0.380	0.420	9.65	10.67
C	0.178	0.188	4.52	4.78
D	0.025	0.035	0.64	0.89
F	0.142	0.147	3.61	3.73
G	0.095	0.105	2.41	2.67
H	0.110	0.130	2.79	3.30
J	0.018	0.024	0.46	0.61
K	0.540	0.575	13.72	14.61
L	0.060	0.075	1.52	1.91
N	0.195	0.205	4.95	5.21
Q	0.105	0.115	2.67	2.92
R	0.085	0.095	2.16	2.41
S	0.045	0.060	1.14	1.52
T	0.235	0.255	5.97	6.47
U	0.000	0.050	0.00	1.27
V	0.045	—	1.15	—
Z	—	0.080	—	2.04

Pin Assignment	
1	Cathode
2	Anode
3	Gate
4	Anode

### Ordering Information

Device	Package	Shipping
MCR8NG	TO-220AB (Pb-Free)	1000 Units/ Box
MAC3030-8G	TO-220AB (Pb-Free)	1000 Units/ Box

1. Dimensioning And Tolerancing Per Ansi Y14.5m, 1982.  
 2. Controlling Dimension: Inch.  
 3. Dimension Z Defines A Zone Where All Body And Lead Irregularities Are Allowed.