

# SMF4L-T1G Series

## Surface Mount - 400 W, Low Leakage Performance



### Maximum Ratings & Thermal Characteristics

Parameter	Symbol	Value	Unit
Maximum $P_{PK}$ Dissipation (PW=10/1000 $\mu$ s) (Note 1)	$P_{PK}$	400	W
DC Power Dissipation @ $T_A = 25^\circ\text{C}$ (Note 2) Derate Above $25^\circ\text{C}$	$P_D$	385	mW
Thermal Resistance from Junction to Ambient (Note 2)	$R_{\theta JA}$	4.0	$\text{mW}/^\circ\text{C}$
Thermal Resistance, Junction to Lead (Note 3)	$R_{\theta JL}$	325	$^\circ\text{C}/\text{W}$
Operating and Storage Temperature Range	$T_J, T_{stg}$	-55 to +150	$^\circ\text{C}$

Stresses exceeding Maximum Ratings may damage the component. Maximum Ratings are stress ratings only. Functional operation above the Recommended Operating Conditions is not implied. Extended exposure to stresses above the Recommended Operating Conditions may affect component reliability.

1. Non-repetitive current pulse at  $T_A = 25^\circ\text{C}$
2. Mounted with recommended minimum pad size, DC board FR-4.
3. 1/2 sine wave (or equivalent square wave), PW = 8.3 ms, duty cycle = 4 pulses per minute maximum.

### Description

The SMF4L-T1G series protects sensitive systems or components from high voltage, high energy transients. It offers a fast response time, low Zener impedance, high surge and excellent clamping capabilities. Because of its small size, it is ideal for use in cellular phones, portable devices, business machines, power supplies and other industrial and consumer applications.

### Features

- Zener transient overvoltage suppressors 30 kV (Contact)
- Working peak reverse voltage range 5 V to 78 V for uni-directional
- Peak power: 400 watts @ 10/1000  $\mu$ s
- Low leakage
- Response time is typically < 1 ns
- ESD rating of class 3 (> 16 kV) per human body model
- IEC-61000-4-2 ESD 30 kV(Air),
- Small footprint: SOD123FL package (footprint area of 8.45  $\text{mm}^2$ )
- Supplied in 8 mm tape and reel – 3,000 units per reel
- Lead orientation in tape: cathode lead to sprocket holes
- These components are Pb-free and are RoHS compliant

### Applications

SMF4L-T1G Series is ideal for the protection of I/O interfaces, Vcc bus and other vulnerable circuit used in cellular phones, portable electronics, business machines, power supplies and other consumer applications. The low leakage is particularly well suited for battery operated electronics.

### Functional Diagram

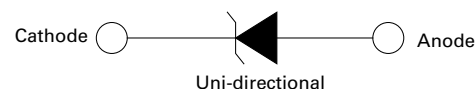

# SMF4L-T1G Series

## Surface Mount - 400 W, Low Leakage Performance

### Electrical Characteristics

Part Number (Uni)	Marking	Working Peak Reverse Voltage $V_{RWM}$ (V) (note 4)	Breakdown Voltage $V_{BR}$ (V) @ $I_T$ (note 5)		Test Current $I_T$ (mA)	Maximum Clamping Voltage $V_C$ @ $I_{PP}$ (V)	Maximum Peak Pulse Current $I_{PP}$ (A)	Maximum Reverse Leakage $I_R$ @ $V_R$ ( $\mu$ A)
			Min	Max				
SMF4L5.0AT1G	QE	5.0	6.40	7.00	10	9.2	43.5	50.0
SMF4L6.0AT1G	QG	6.0	6.67	7.37	10	10.3	38.8	50.0
SMF4L6.5AT1G	QK	6.5	7.22	7.98	10	11.2	35.7	40.0
SMF4L7.0AT1G	QL	7.0	7.78	8.60	10	12.0	33.3	40.0
SMF4L7.5AT1G	QN	7.5	8.33	9.21	1	12.9	31.0	30.0
SMF4L8.0AT1G	QR	8.0	8.89	9.83	1	13.6	29.4	5.0
SMF4L8.5AT1G	QT	8.5	9.44	10.40	1	14.4	27.8	5.0
SMF4L9.0AT1G	QV	9.0	10.00	11.10	1	15.4	26.0	0.5
SMF4L10AT1G	QX	10	11.10	12.30	1	17.0	23.5	0.5
SMF4L11AT1G	QZ	11	12.20	13.50	1	18.2	22.0	0.5
SMF4L12AT1G	RE	12	13.30	14.70	1	19.9	20.1	0.5
SMF4L13AT1G	RG	13	14.40	15.90	1	21.5	18.6	0.1
SMF4L14AT1G	RH	14	15.60	17.20	1	23.2	17.2	0.1
SMF4L15AT1G	RM	15	16.70	18.50	1	24.4	16.4	0.1
SMF4L16AT1G	RP	16	17.80	19.70	1	26.0	15.4	0.1
SMF4L17AT1G	RR	17	18.90	20.90	1	27.6	14.5	0.1
SMF4L18AT1G	RT	18	20.00	22.10	1	29.2	13.7	0.1
SMF4L20AT1G	RV	20	22.20	24.50	1	32.4	12.3	0.1
SMF4L22AT1G	RX	22	24.40	26.90	1	35.5	11.3	0.1
SMF4L24AT1G	RZ	24	26.70	29.50	1	38.9	10.3	0.1
SMF4L26AT1G	SE	26	28.90	31.90	1	42.1	9.5	0.1
SMF4L28AT1G	SG	28	31.10	34.30	1	45.4	8.8	0.1
SMF4L30AT1G	SK	30	33.30	36.80	1	48.4	8.3	0.1
SMF4L33AT1G	SM	33	36.70	40.60	1	53.3	7.5	0.1
SMF4L36AT1G	SP	36	40.00	44.20	1	58.1	6.9	0.1
SMF4L40AT1G	SR	40	44.40	49.10	1	64.5	6.2	0.1
SMF4L43AT1G	ST	43	47.80	52.80	1	69.4	5.8	0.1
SMF4L45AT1G	SV	45	50.00	55.30	1	72.7	5.5	0.1
SMF4L48AT1G	SX	48	53.30	58.90	1	77.4	5.2	0.1
SMF4L51AT1G	SZ	51	56.70	62.70	1	82.4	4.9	0.1
SMF4L54AT1G	TE	54	60.00	66.30	1	87.1	4.6	0.1
SMF4L58AT1G	TG	58	64.40	71.20	1	93.6	4.3	0.1
SMF4L60AT1G	TI	60	66.70	73.70	1	96.8	4.1	0.1
SMF4L64AT1G	TM	64	71.10	78.60	1	103.0	3.9	0.1
SMF4L70AT1G	RP	70	77.80	86.00	1	113.0	3.5	0.1
SMF4L75AT1G	TR	75	83.30	92.10	1	121.0	3.3	0.1
SMF4L78AT1G	TT	78	86.70	95.80	1	126.0	3.2	0.1

4. A transient suppressor is normally selected according to the working peak reverse voltage ( $V_{RWM}$ ), which should be equal to or greater than the DC or continuous peak operating voltage level

5.  $V_{BR}$  measured at pulse test current  $I_T$  at an ambient temperature of 25 °C

# SMF4L-T1G Series

## Surface Mount - 400 W, Low Leakage Performance

I-V Curve Characteristics ( $T_A = 25\text{ }^\circ\text{C}$  unless otherwise noted,  $V_F = 3.5\text{ V Max. @ } I_F = 30\text{ A}$ )\* For Uni-directional

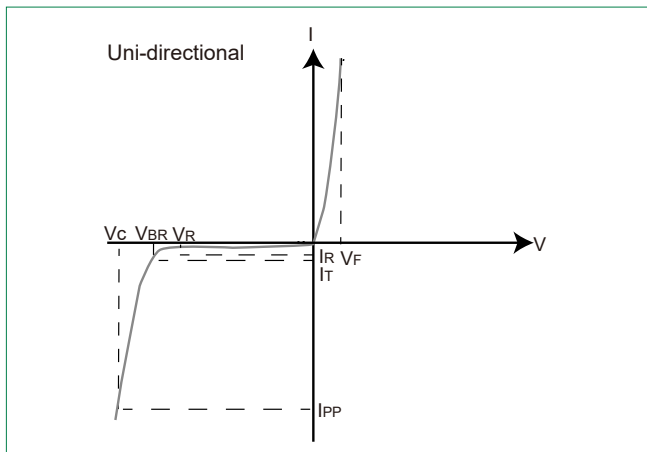

Figure 1. Pulse Rating Curve

Symbol	Parameter
$I_{PP}$	Maximum Reverse Peak Pulse Current
$V_C$	Clamping Voltage @ $I_{PP}$
$V_{RWM}$	Working Peak Reverse Voltage
$I_R$	Maximum Reverse Leakage Current @ $V_{RWM}$
$V_{BR}$	Breakdown Voltage @ $I_T$
$I_T$	Breakdown Current
$V_F$	Forward Voltage @ $I_F$
$I_F$	Forward Current

\*1/2 sine wave (or equivalent square wave), PW = 8.3 ms, non-repetitive duty cycle.

Figure 2. 10/1000  $\mu\text{s}$  Pulse Waveform

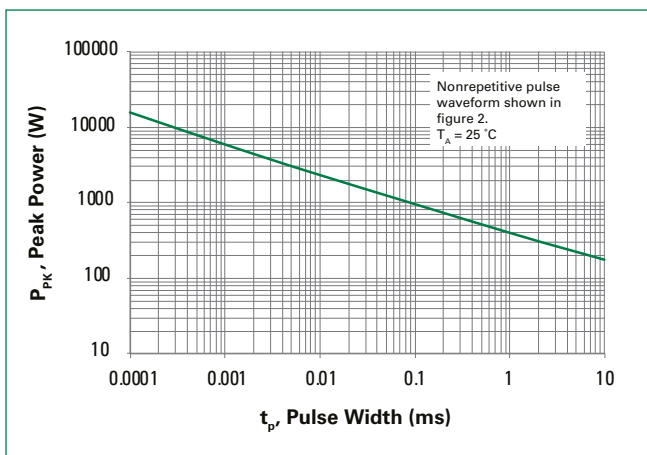

Figure 3. Typical Junction Capacitance vs. Bias Voltage

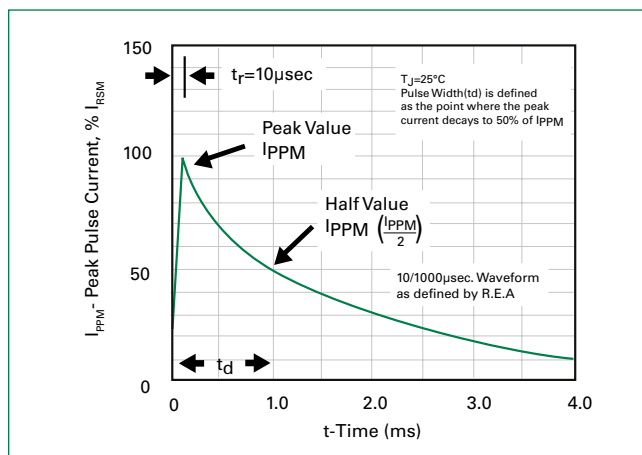
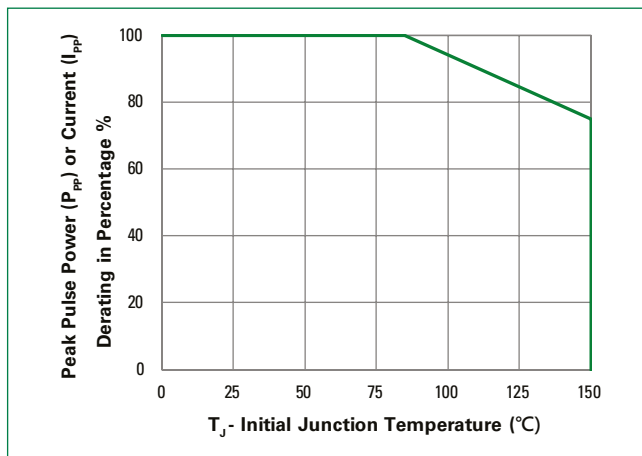
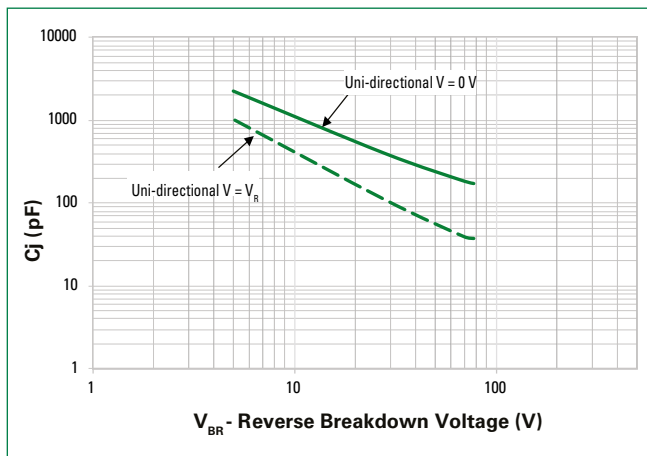

Figure 4. Surge Derating Curve



# SMF4L-T1G Series

## Surface Mount - 400 W, Low Leakage Performance

### Soldering Parameters

<b>Reflow Condition</b>		Lead-free assembly
<b>Pre Heat</b>	- Temperature Min ( $T_{s(min)}$ )	150 °C
	- Temperature Max ( $T_{s(max)}$ )	200 °C
	- Time (min to max) ( $t_s$ )	60 – 120 seconds
<b>Average Ramp Up Rate (Liquidus Temp (<math>T_L</math>) to Peak)</b>		3 °C/second max
<b><math>T_{s(max)}</math> to <math>T_L</math> - Ramp-up Rate</b>		3 °C/second max
<b>Reflow</b>	- Temperature ( $T_L$ ) (Liquidus)	217 °C
	- Time (min to max) ( $t_s$ )	60 – 150 seconds
<b>Peak Temperature (<math>T_p</math>)</b>		260 <sup>+0/-5</sup> °C
<b>Time within 5 °C of Actual Peak Temperature (<math>t_p</math>)</b>		30 seconds max
<b>Ramp-down Rate</b>		6 °C/second max
<b>Time 25 °C to Peak Temperature (<math>T_p</math>)</b>		8 minutes max
<b>Do Not Exceed</b>		260 °C

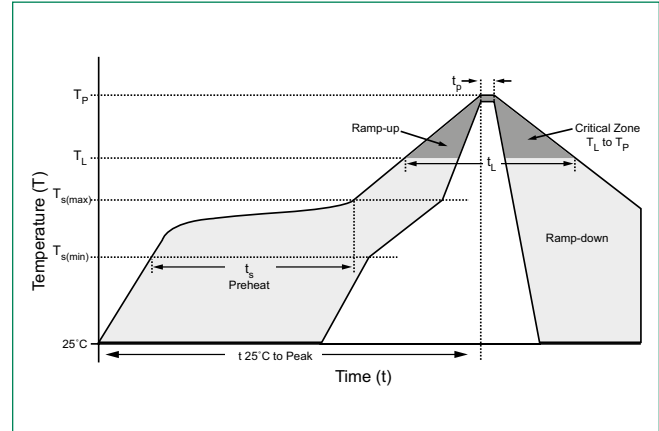

### Physical Specifications

<b>Weight</b>	0.004 ounce, 0.0116 grams
<b>Case</b>	JEDEC SOD-123FL. Void-free, transfermolded
<b>Polarity</b>	Color band denotes cathode for unidirectional components.
<b>Terminal</b>	Matte Tin-plated leads, solderable per JESD22-B102

### Environmental Specifications

<b>High Temperature Storage</b>	JESD22-A103
<b>HTRB</b>	JESD22-A108
<b>Temperature Cycling</b>	JESD22-A104
<b>MSL</b>	JEDEC-J-STD-020, Level 1
<b>H3TRB</b>	JESD22-A101
<b>RSH</b>	JESD22-A111

### Dimensions

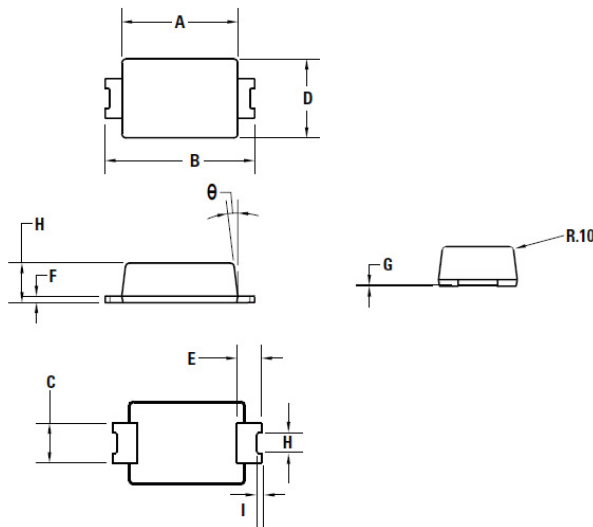

Dim	Millimeters		Inches	
	Min	Max	Min	Max
A	2.70	2.90	0.106	0.114
B	3.50	3.70	0.138	0.146
C	0.85	1.05	0.033	0.041
D	1.80	2.00	0.071	0.079
E	0.40	0.80	0.016	0.031
F	0.10	0.20	0.004	0.008
G	0.00	0.05	0.000	0.002
H	0.90	0.98	0.035	0.039
I	0.00	0.20	0.000	0.008
J	0.40	0.60	0.016	0.024
θ	0°	7°	0°	7°

### Ordering Information

Device	Package	Shipping
SMF4LxxxAT1G	SOD-123FL (Pb-Free)	3,000 / Tape & Reel

# SMF4L-T1G Series

## Surface Mount - 400 W, Low Leakage Performance

### Part Numbering System

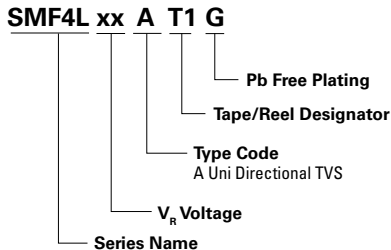

### Part Marking System

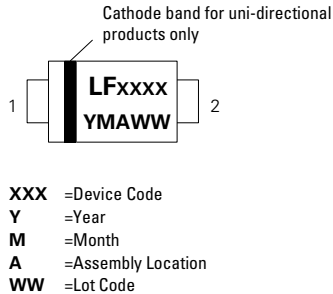

### Tape and Reel Specification

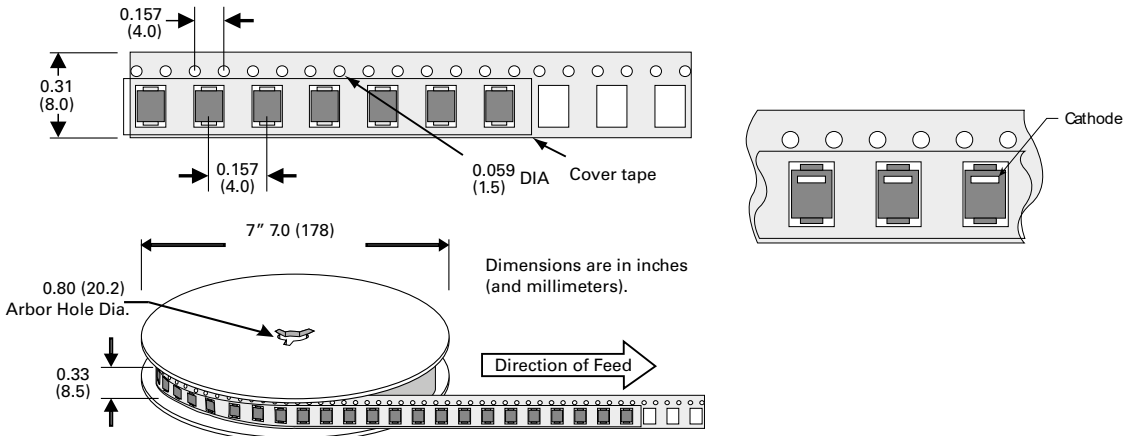

**Disclaimer Notice** - Information furnished is believed to be accurate and reliable. However, users should independently evaluate the suitability of and test each product selected for their own applications. Littelfuse products are not designed for, and may not be used in, all applications. Read complete Disclaimer Notice at <http://www.littelfuse.com/disclaimer-electronics>.