

HiPerFRED

V_{RRM}	=	600 V
I_{FAV}	=	15 A
t_{rr}	=	25 ns

High Performance Fast Recovery Diode
 Low Loss and Soft Recovery
 Single Diode

Part number

DPG30I600PM

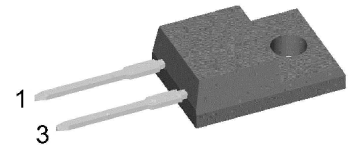

Backside: isolated

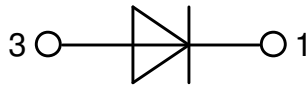

Features / Advantages:

- Planar passivated chips
- Very low leakage current
- Very short recovery time
- Improved thermal behaviour
- Very low I_{rm} -values
- Very soft recovery behaviour
- Avalanche voltage rated for reliable operation
- Soft reverse recovery for low EMI/RFI
- Low I_{rm} reduces:
 - Power dissipation within the diode
 - Turn-on loss in the commutating switch

Applications:

- Antiparallel diode for high frequency switching devices
- Antisaturation diode
- Snubber diode
- Free wheeling diode
- Rectifiers in switch mode power supplies (SMPS)
- Uninterruptible power supplies (UPS)

Package: TO-220FP

- Isolation Voltage: 2500 V~
- Industry standard outline
- RoHS compliant
- Epoxy meets UL 94V-0

Disclaimer Notice

Information furnished is believed to be accurate and reliable. However, users should independently evaluate the suitability of and test each product selected for their own applications. Littelfuse products are not designed for, and may not be used in, all applications. Read complete Disclaimer Notice at www.littelfuse.com/disclaimer-electronics.



Fast Diode				Ratings			
Symbol	Definition	Conditions	min.	typ.	max.	Unit	
V_{RSM}	max. non-repetitive reverse blocking voltage	$T_{VJ} = 25^{\circ}C$			600	V	
V_{RRM}	max. repetitive reverse blocking voltage	$T_{VJ} = 25^{\circ}C$			600	V	
I_R	reverse current, drain current	$V_R = 600 V$	$T_{VJ} = 25^{\circ}C$		250	μA	
		$V_R = 600 V$	$T_{VJ} = 150^{\circ}C$		2	mA	
V_F	forward voltage drop	$I_F = 30 A$	$T_{VJ} = 25^{\circ}C$		2,52	V	
		$I_F = 60 A$			3,22	V	
		$I_F = 30 A$	$T_{VJ} = 150^{\circ}C$		1,63	V	
		$I_F = 60 A$			2,27	V	
I_{FAV}	average forward current	$T_C = 95^{\circ}C$ rectangular $d = 0.5$	$T_{VJ} = 175^{\circ}C$		15	A	
V_{FO}	threshold voltage	} for power loss calculation only	$T_{VJ} = 175^{\circ}C$		0,84	V	
r_F	slope resistance				20	m Ω	
R_{thJC}	thermal resistance junction to case				3,5	K/W	
R_{thCH}	thermal resistance case to heatsink			0,5		K/W	
P_{tot}	total power dissipation		$T_C = 25^{\circ}C$		165	W	
I_{FSM}	max. forward surge current	$t = 10 ms; (50 Hz), sine; V_R = 0 V$	$T_{VJ} = 45^{\circ}C$		250	A	
C_J	junction capacitance	$V_R = 400V \quad f = 1 MHz$	$T_{VJ} = 25^{\circ}C$		26	pF	
I_{RM}	max. reverse recovery current	} $I_F = 30 A; V_R = 300 V$ $-di_F/dt = 200 A/\mu s$	$T_{VJ} = 25^{\circ}C$		2,5	A	
			$T_{VJ} = 100^{\circ}C$		4,5	A	
t_{rr}	reverse recovery time		$T_{VJ} = 25^{\circ}C$		25	ns	
			$T_{VJ} = 100^{\circ}C$		70	ns	



Package TO-220FP		Ratings				
Symbol	Definition	Conditions	min.	typ.	max.	Unit
I_{RMS}	RMS current	per terminal			35	A
T_{VJ}	virtual junction temperature		-55		175	°C
T_{op}	operation temperature		-55		150	°C
T_{stg}	storage temperature		-55		150	°C
Weight				2		g
M_D	mounting torque		0,4		0,6	Nm
F_C	mounting force with clip		20		60	N
$d_{Spp/App}$	creepage distance on surface striking distance through air	terminal to terminal	3,2	2,7		mm
$d_{Spb/Apb}$		terminal to backside	2,5	2,5		mm
V_{ISOL}	isolation voltage	t = 1 second	2500			V
		t = 1 minute	2100			V

Product Marking

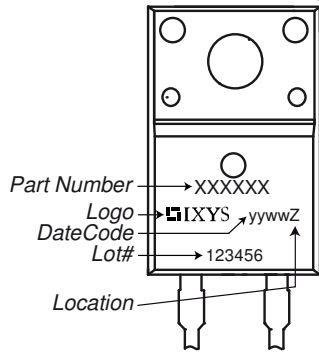

Part description

- D = Diode
- P = HiPerFRED
- G = extreme fast
- 30 = Current Rating [A]
- I = Single Diode
- 600 = Reverse Voltage [V]
- PM = TO-220ACFP (2)

Ordering	Ordering Number	Marking on Product	Delivery Mode	Quantity	Code No.
Standard	DPG30I600PM	DPG30I600PM	Tube	50	521763

Equivalent Circuits for Simulation

** on die level*

$T_{VJ} = 175^{\circ}C$

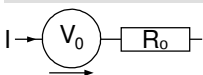

Fast Diode

$V_{0\ max}$	threshold voltage	0,84	V
$R_{0\ max}$	slope resistance *	17	mΩ



Outlines TO-220FP

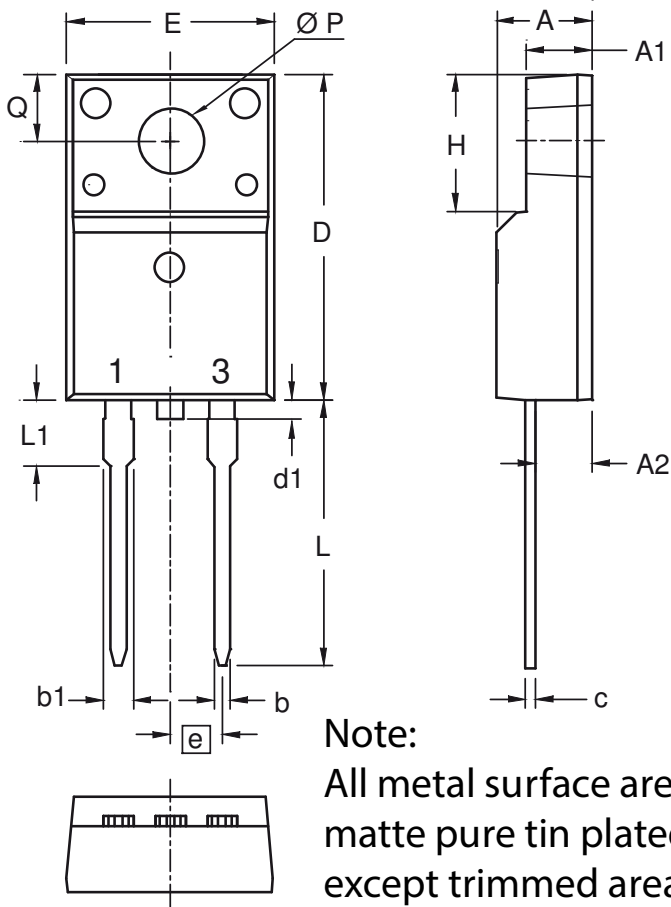

Dim.	Millimeters		Inches	
	min	max	min	max
A	4.50	4.90	0.177	0.193
A1	2.34	2.74	0.092	0.108
A2	2.56	2.96	0.101	0.117
b	0.70	0.90	0.028	0.035
b1	1.27	1.47	0.050	0.058
c	0.45	0.60	0.018	0.024
D	15.67	16.07	0.617	0.633
d1	0	1.10	0	0.043
E	9.96	10.36	0.392	0.408
e	2.54 BSC		0.100 BSC	
H	6.48	6.88	0.255	0.271
L	12.68	13.28	0.499	0.523
L1	3.03	3.43	0.119	0.135
ØP	3.08	3.28	0.121	0.129
Q	3.20	3.40	0.126	0.134



Fast Diode

 Fig. 1 Forward current I_F versus V_F

 Fig. 2 Typ. reverse recovery charge Q_r versus $-di_F/dt$

 Fig. 3 Typ. peak reverse current I_{RM} versus $-di_F/dt$

 Fig. 4 Dynamic parameters Q_r , I_{RM} versus T_{VJ}

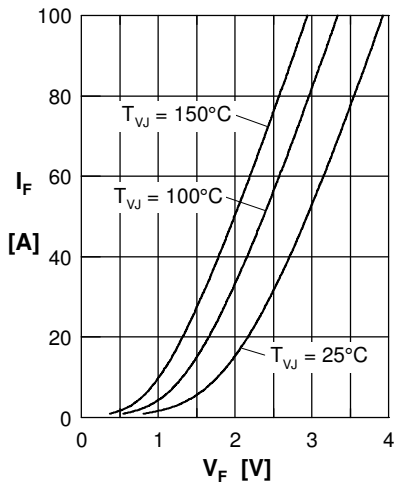
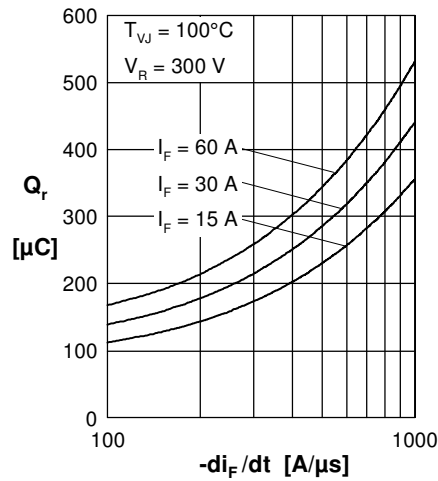
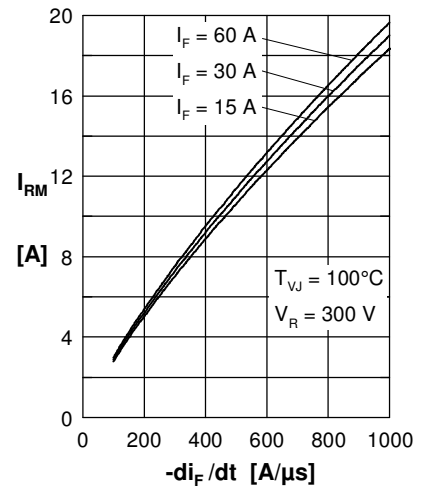
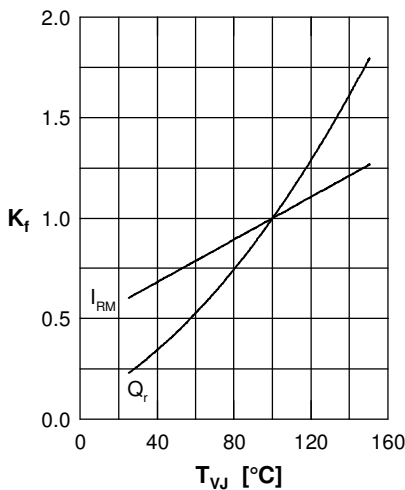
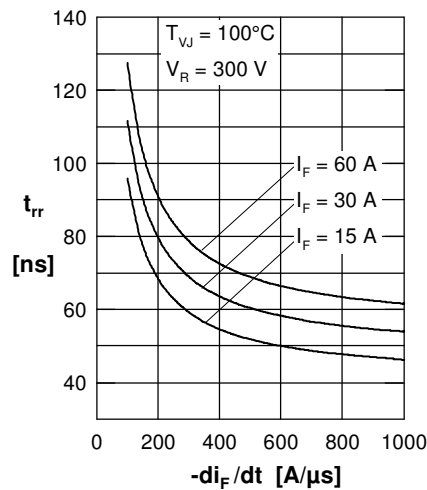
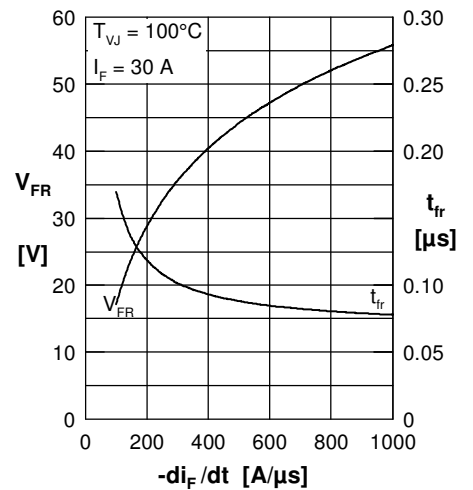
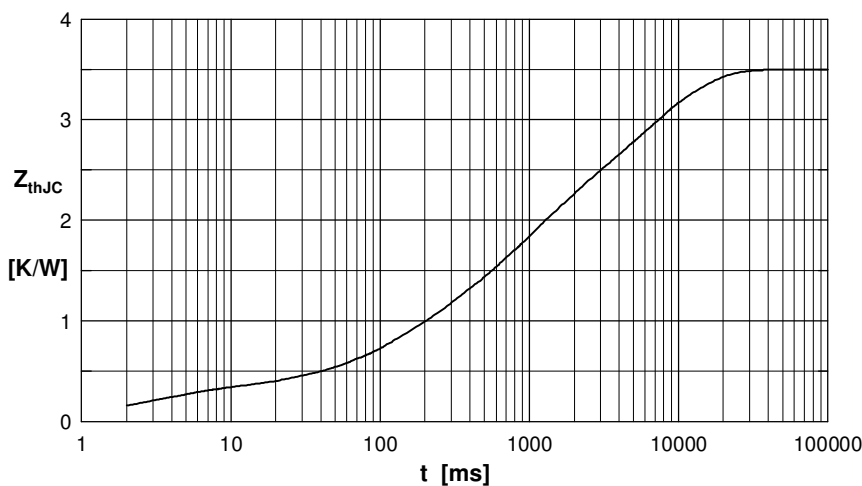
 Fig. 5 Typ. recovery time t_{tr} versus $-di_F/dt$

 Fig. 6 Typ. peak forward voltage V_{FR} and t_{tr} versus di_F/dt

Fig. 7 Transient thermal impedance junction to case

 Constants for Z_{thJC} calculation:

i	R_{thi} (K/W)	t_i (s)
1	0.30	0.003
2	0.50	0.130
3	1.15	0.800
4	1.55	6.500