

## GenX3™ 600V IGBTs

## IXGA30N60C3 IXGP30N60C3\* IXGH30N60C3

\*Obsolete Part Number

High-Speed PT IGBTs for 40-100kHz Switching

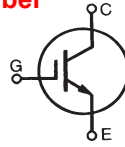

$V_{CES} = 600V$   
 $I_{C110} = 30A$   
 $V_{CE(sat)} \leq 3.0V$   
 $t_{fi(typ)} = 47ns$

Symbol	Test Conditions	Maximum Ratings	
$V_{CES}$	$T_C = 25^\circ C$ to $150^\circ C$	600	V
$V_{CGR}$	$T_J = 25^\circ C$ to $150^\circ C$ , $R_{GE} = 1M\Omega$	600	V
$V_{GES}$	Continuous	$\pm 20$	V
$V_{GEM}$	Transient	$\pm 30$	V
$I_{C25}$	$T_C = 25^\circ C$	60	A
$I_{C110}$	$T_C = 110^\circ C$	30	A
$I_{CM}$	$T_C = 25^\circ C$ , 1ms	150	A
<b>SSOA</b> <b>(RBSOA)</b>	$V_{GE} = 15V$ , $T_{VJ} = 125^\circ C$ , $R_G = 5\Omega$ Clamped Inductive Load	$I_{CM} = 60$ @ $\leq V_{CES}$	A
$P_C$	$T_C = 25^\circ C$	220	W
$T_J$		-55 ... +150	$^\circ C$
$T_{JM}$		150	$^\circ C$
$T_{stg}$		-55 ... +150	$^\circ C$
$T_L$	1.6mm (0.062 in.) from Case for 10s	300	$^\circ C$
$T_{SOLD}$	Plastic Body for 10 seconds	260	$^\circ C$
$M_d$	Mounting Torque (TO-220 & TO-247)	1.13/10	Nm/lb.in.
<b>Weight</b>	TO-220	2.5	g
	TO-263	3.0	g
	TO-263	3.0	g

TO-263 AA (IXGA)

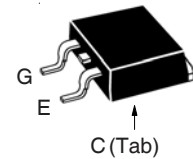

TO-220AB (IXGP)

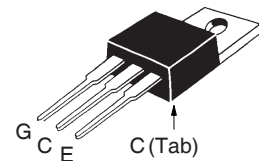

TO-247 (IXGH)

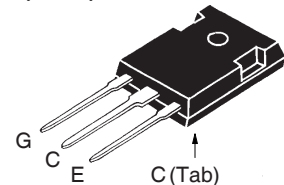

G = Gate      D = Collector  
S = Emitter    Tab = Collector

### Features

- Optimized for Low Switching Losses
- Square RBSOA
- International Standard Packages

### Advantages

- High Power Density
- Low Gate Drive Requirement

### Applications

- High Frequency Power Inverters
- UPS
- Motor Drives
- SMPS
- PFC Circuits
- Battery Chargers
- Welding Machines
- Lamp Ballasts

Symbol	Test Conditions ( $T_J = 25^\circ C$ Unless Otherwise Specified)	Characteristic Values		
		Min.	Typ.	Max.
$BV_{CES}$	$I_C = 250\mu A$ , $V_{GE} = 0V$	600		V
$V_{GE(th)}$	$I_C = 250\mu A$ , $V_{CE} = V_{GE}$	3.0		5.5 V
$I_{CES}$	$V_{CE} = V_{CES}$ , $V_{GE} = 0V$ $T_J = 125^\circ C$			15 $\mu A$
				300 $\mu A$
$I_{GES}$	$V_{CE} = 0V$ , $V_{GE} = \pm 20V$			$\pm 100$ nA
$V_{CE(sat)}$	$I_C = 20A$ , $V_{GE} = 15V$ , Note 1 $T_J = 125^\circ C$	2.6		3.0 V
		1.8		V

Symbol	Test Conditions	Characteristic Values		
		Min.	Typ.	Max.
$g_{fs}$	$I_C = 20A, V_{CE} = 10V$ , Note 1	9	16	S
$C_{ies}$	$V_{CE} = 25V, V_{GE} = 0V, f = 1MHz$		915	pF
$C_{oes}$			78	pF
$C_{res}$			32	pF
$Q_g$	$I_C = 20A, V_{GE} = 15V, V_{CE} = 0.5 \cdot V_{CES}$		38	nC
$Q_{ge}$			8	nC
$Q_{gc}$			17	nC
$t_{d(on)}$	<b>Inductive Load, <math>T_J = 25^\circ C</math></b> $I_C = 20A, V_{GE} = 15V$ $V_{CE} = 300V, R_G = 5\Omega$ Note 2		16	ns
$t_{ri}$			26	ns
$E_{on}$			0.27	mJ
$t_{d(off)}$			42	75 ns
$t_{fi}$			47	ns
$E_{off}$			0.09	0.18 mJ
$t_{d(on)}$	<b>Inductive Load, <math>T_J = 125^\circ C</math></b> $I_C = 20A, V_{GE} = 15V$ $V_{CE} = 300V, R_G = 5\Omega$ Note 2		17	ns
$t_{ri}$			28	ns
$E_{on}$			0.44	mJ
$t_{d(off)}$			70	ns
$t_{fi}$			90	ns
$E_{off}$			0.33	mJ
$R_{thJC}$			0.56	$^\circ C/W$
$R_{thCS}$	TO-220	0.50		$^\circ C/W$
	TO-247	0.21		$^\circ C/W$

**Notes:**

1. Pulse test,  $t \leq 300\mu s$ , duty cycle,  $d \leq 2\%$ .
2. Switching times & energy losses may increase for higher  $V_{CE}$  (Clamp),  $T_J$  or  $R_G$ .

**TO-247 Outline**

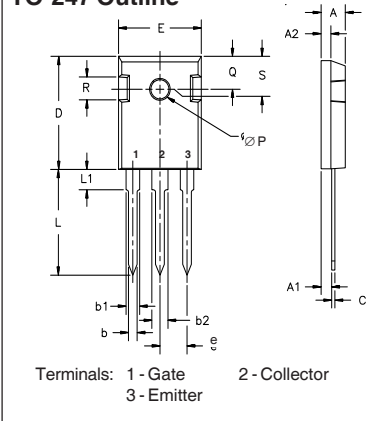

Dim.	Millimeter		Inches	
	Min.	Max.	Min.	Max.
A	4.7	5.3	.185	.209
A <sub>1</sub>	2.2	2.54	.087	.102
A <sub>2</sub>	2.2	2.6	.059	.098
b	1.0	1.4	.040	.055
b <sub>1</sub>	1.65	2.13	.065	.084
b <sub>2</sub>	2.87	3.12	.113	.123
C	.4	.8	.016	.031
D	20.80	21.46	.819	.845
E	15.75	16.26	.610	.640
e	5.20	5.72	0.205	0.225
L	19.81	20.32	.780	.800
L <sub>1</sub>		4.50		.177
∅P	3.55	3.65	.140	.144
Q	5.89	6.40	0.232	0.252
R	4.32	5.49	.170	.216
S	6.15	BSC	242	BSC

**TO-263 Outline**

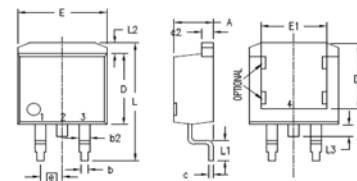

- 1 = Gate
- 2 = Collector
- 3 = Emitter
- 4 = Collector

SYM	INCHES		MILLIMETERS	
	MIN	MAX	MIN	MAX
A	.160	.190	4.06	4.83
A <sub>1</sub>	.080	.110	2.03	2.79
b	.020	.039	0.51	0.99
b <sub>2</sub>	.045	.055	1.14	1.40
c	.016	.029	0.40	0.74
c <sub>2</sub>	.045	.055	1.14	1.40
D	.340	.380	8.64	9.65
D <sub>1</sub>	.315	.350	8.00	8.89
E	.380	.410	9.65	10.41
E <sub>1</sub>	.245	.320	6.22	8.13
e	.100	BSC	2.54	BSC
L	.575	.625	14.61	15.88
L <sub>1</sub>	.090	.110	2.29	2.79
L <sub>2</sub>	.040	.055	1.02	1.40
L <sub>3</sub>	.050	.070	1.27	1.78
L <sub>4</sub>	0	.005	0	0.13

**TO-220 Outline**

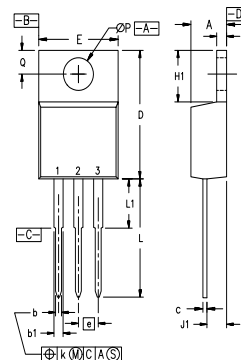

- 1 = Gate
- 2 = Collector
- 3 = Emitter

SYM	INCHES		MILLIMETERS	
	MIN	MAX	MIN	MAX
A	.170	.190	4.32	4.83
b	.025	.040	0.64	1.02
b <sub>1</sub>	.045	.065	1.15	1.65
c	.014	.022	0.35	0.56
D	.580	.630	14.73	16.00
E	.390	.420	9.91	10.66
e	.100	BSC	2.54	BSC
F	.045	.055	1.14	1.40
H <sub>1</sub>	.230	.270	5.85	6.85
J <sub>1</sub>	.090	.110	2.29	2.79
k	0	.015	0	0.38
L	.500	.550	12.70	13.97
L <sub>1</sub>	.110	.230	2.79	5.84
∅P	.139	.161	3.53	4.08
Q	.100	.125	2.54	3.18

IXYS Reserves the Right to Change Limits, Test Conditions and Dimensions.

IXYS MOSFETs and IGBTs are covered by one or more of the following U.S. patents:	4,835,592	4,931,844	5,049,961	5,237,481	6,162,665	6,404,065 B1	6,683,344	6,727,585	7,005,734 B2	7,157,338 B2
	4,850,072	5,017,508	5,063,307	5,381,025	6,259,123 B1	6,534,343	6,710,405 B2	6,759,692	7,063,975 B2	
	4,881,106	5,034,796	5,187,117	5,486,715	6,306,728 B1	6,583,505	6,710,463	6,771,478 B2	7,071,537	

Fig. 1. Output Characteristics @  $T_J = 25^\circ\text{C}$

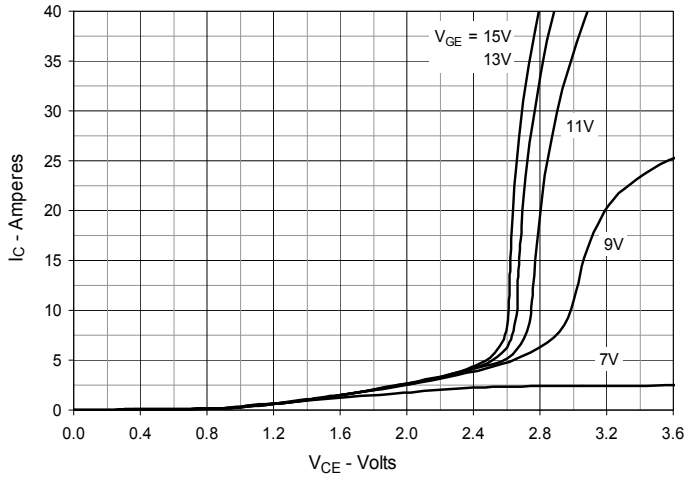

Fig. 2. Extended Output Characteristics @  $T_J = 25^\circ\text{C}$

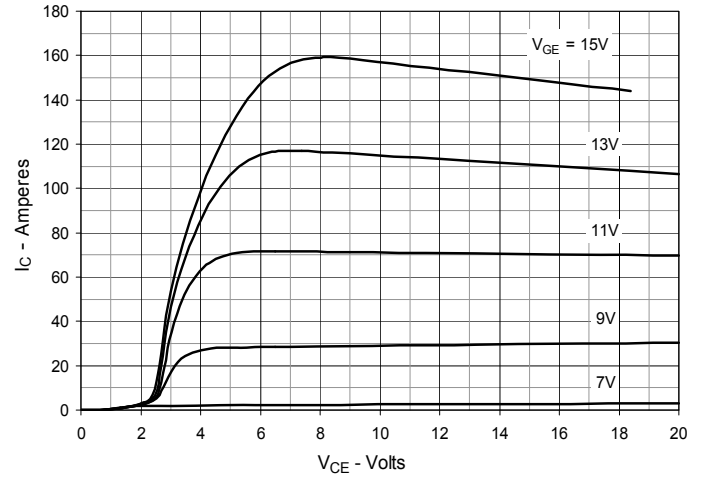

Fig. 3. Output Characteristics @  $T_J = 125^\circ\text{C}$

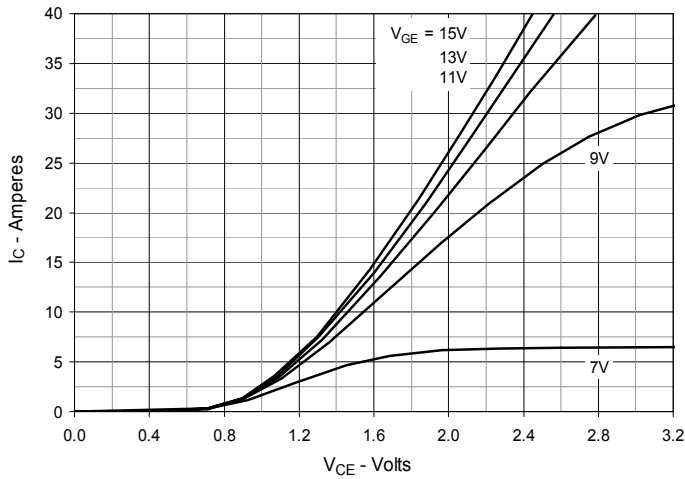

Fig. 4. Dependence of  $V_{CE(sat)}$  on Junction Temperature

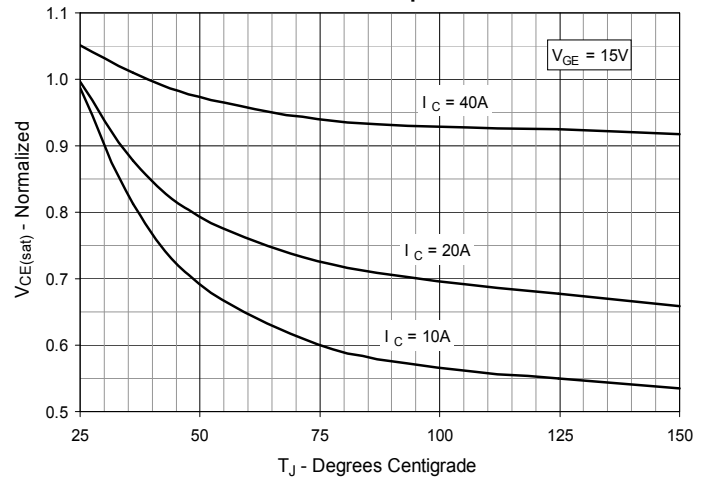

Fig. 5. Collector-to-Emitter Voltage vs. Gate-to-Emitter Voltage

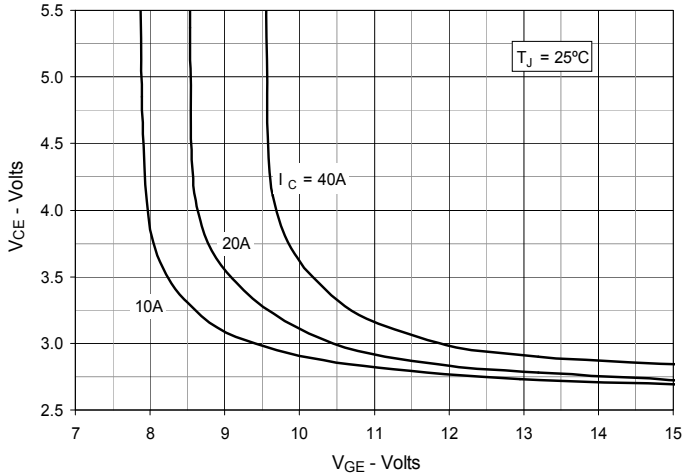

Fig. 6. Input Admittance

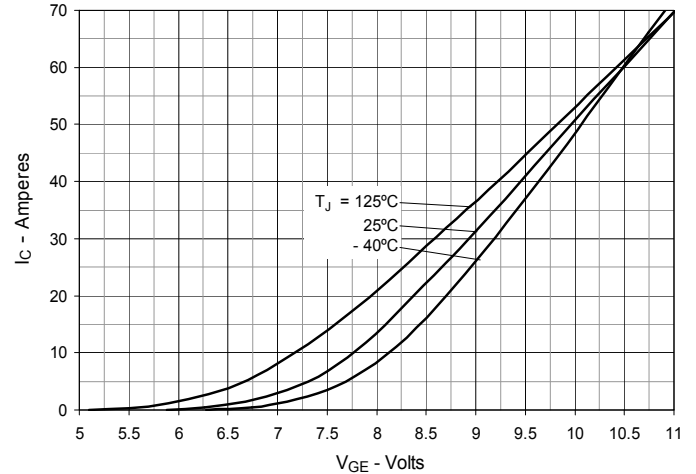

Fig. 7. Transconductance

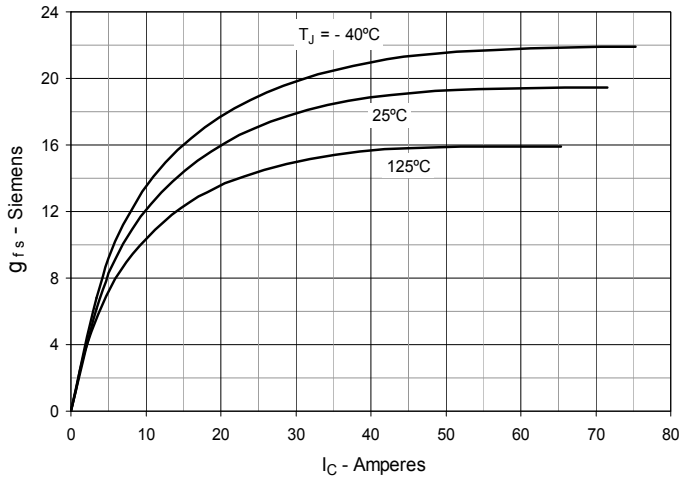

Fig. 8. Gate Charge

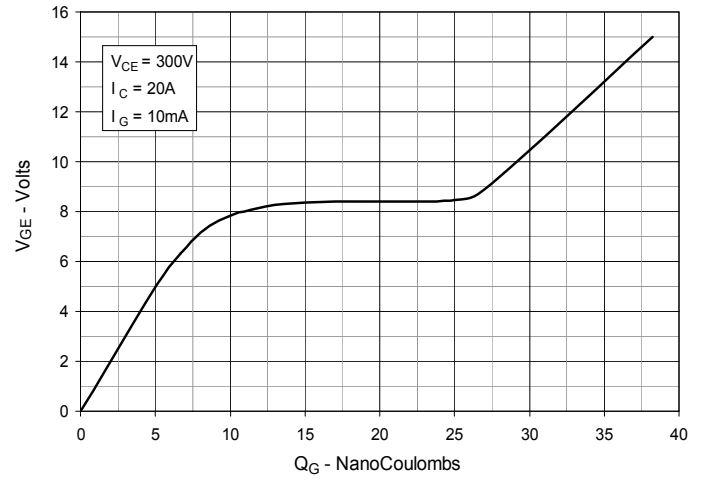

Fig. 9. Capacitance

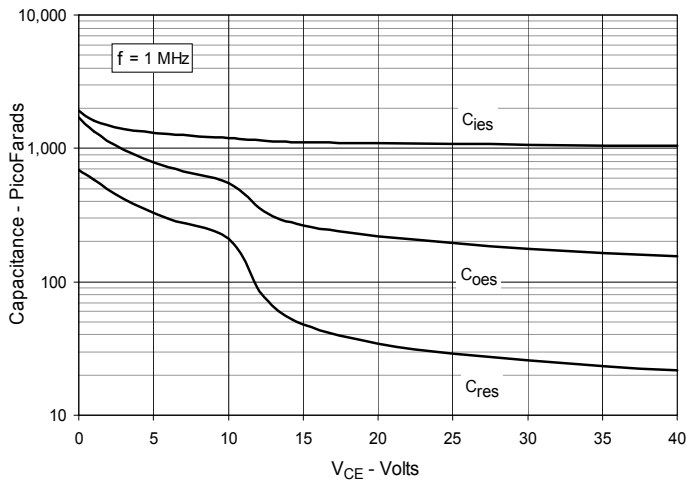

Fig. 10. Reverse-Bias Safe Operating Area

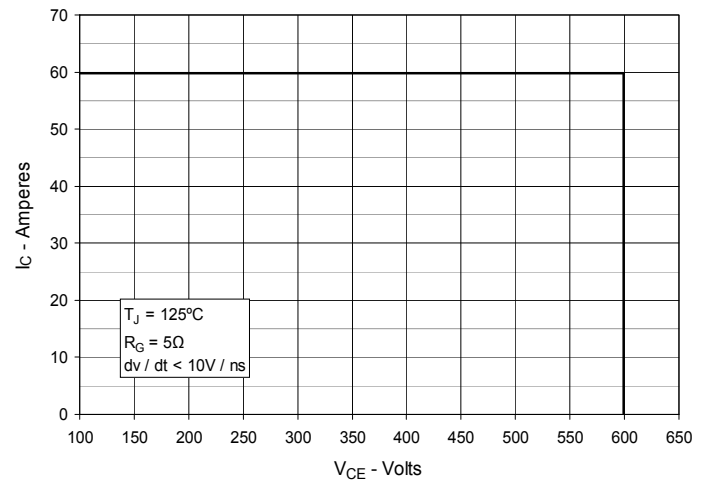
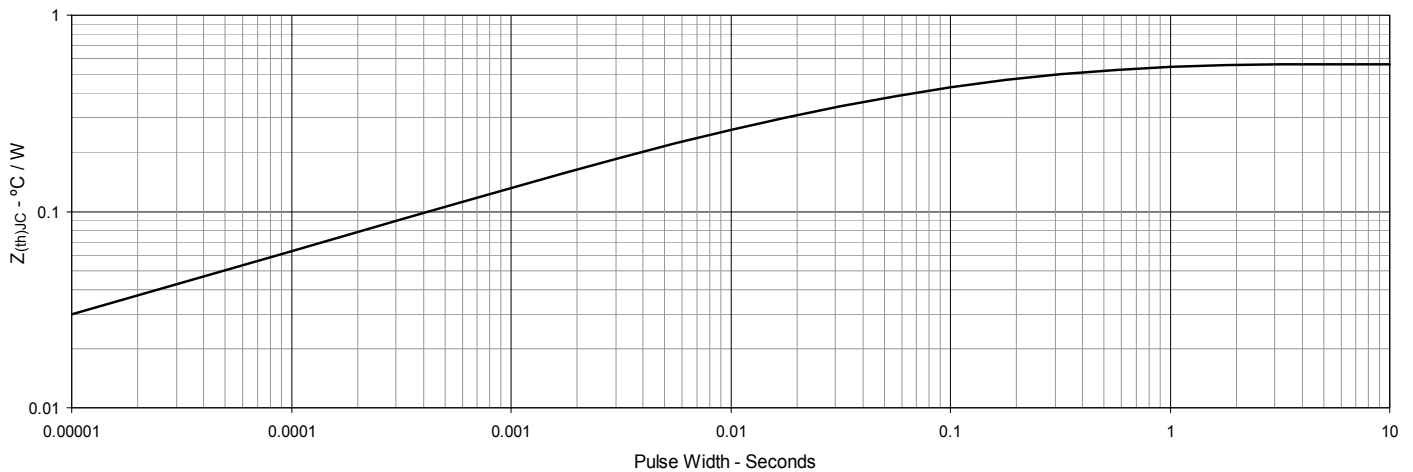
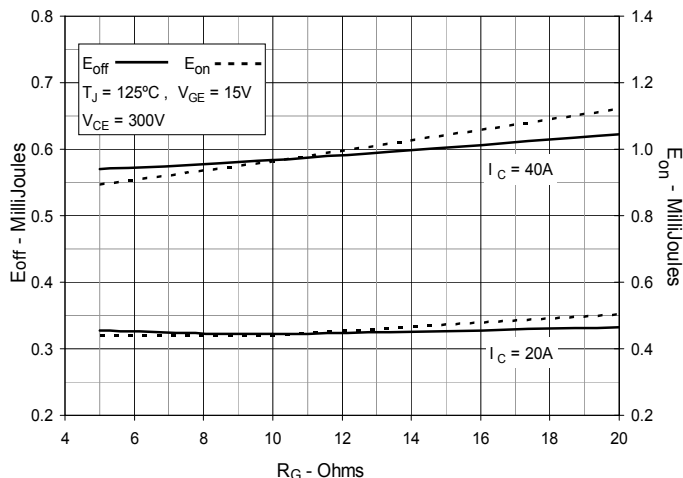

Fig. 11. Maximum Transient Thermal Impedance for IGBT



**Fig. 12. Inductive Switching Energy Loss vs. Gate Resistance**



**Fig. 13. Inductive Switching Energy Loss vs. Collector Current**

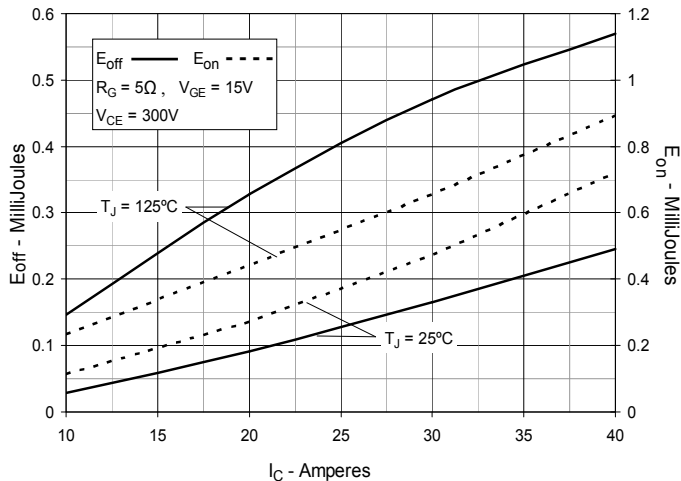

**Fig. 14. Inductive Switching Energy Loss vs. Junction Temperature**

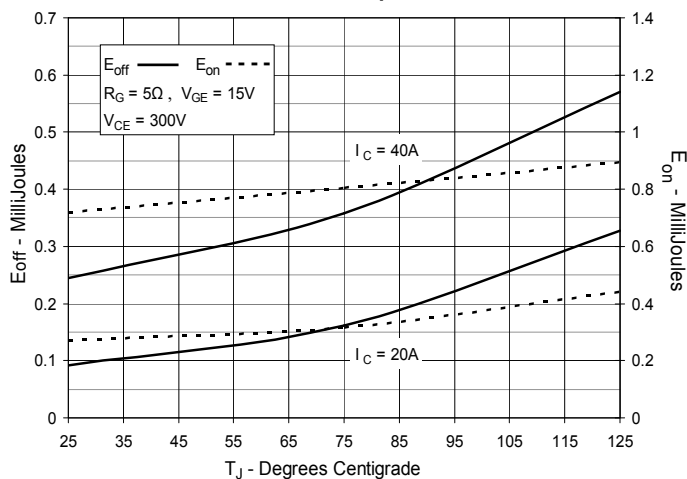

**Fig. 15. Inductive Turn-off Switching Times vs. Gate Resistance**

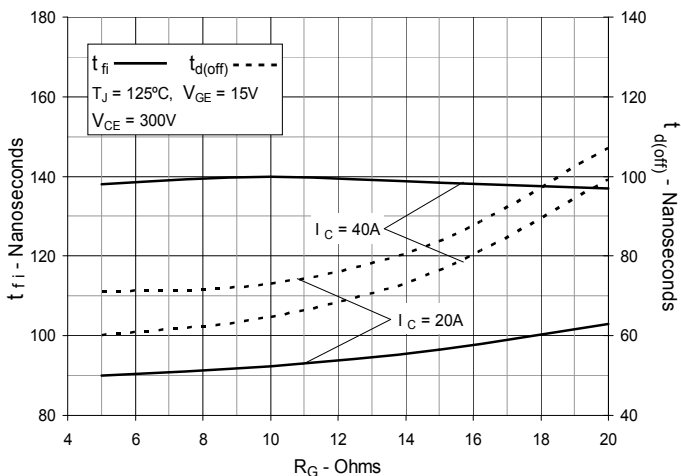

**Fig. 16. Inductive Turn-off Switching Times vs. Collector Current**

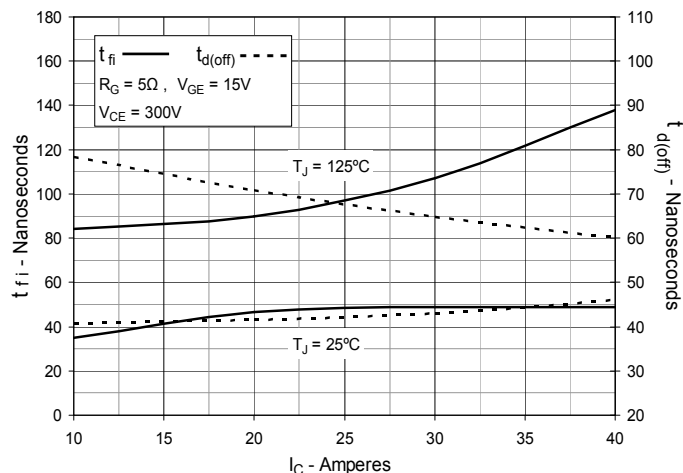

**Fig. 17. Inductive Turn-off Switching Times vs. Junction Temperature**

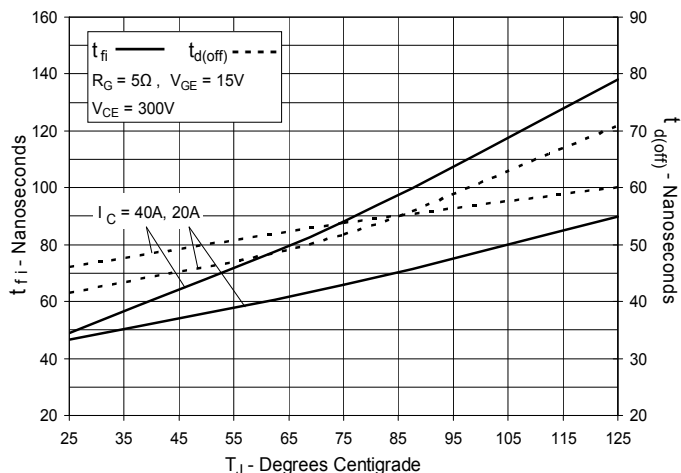

**Fig. 18. Inductive Turn-on Switching Times vs. Gate Resistance**

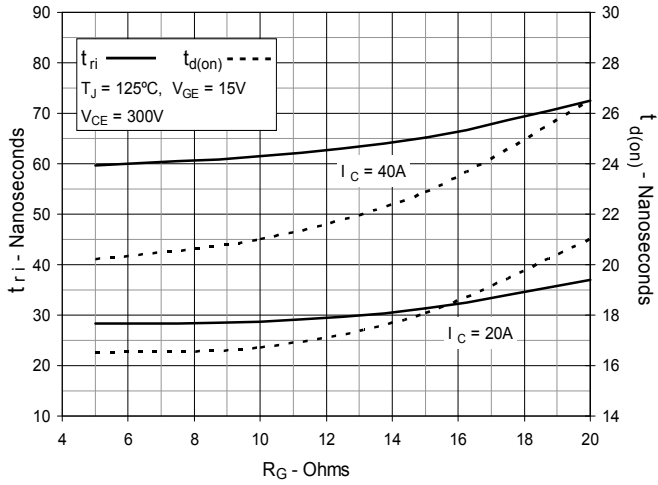

**Fig. 19. Inductive Turn-on Switching Times vs. Collector Current**

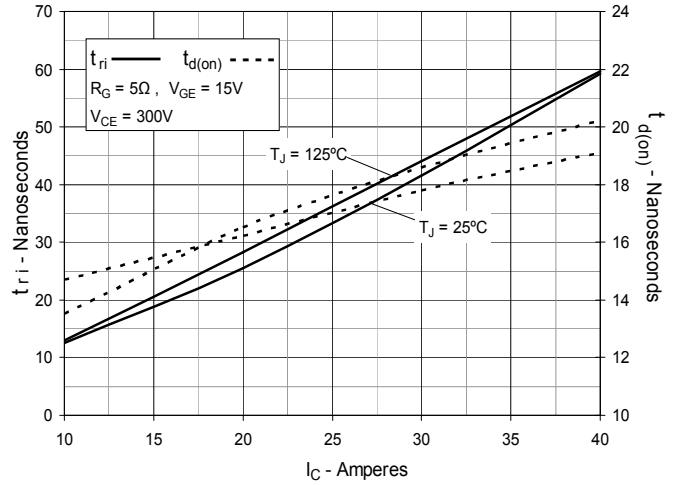

**Fig. 20. Inductive Turn-on Switching Times vs. Junction Temperature**

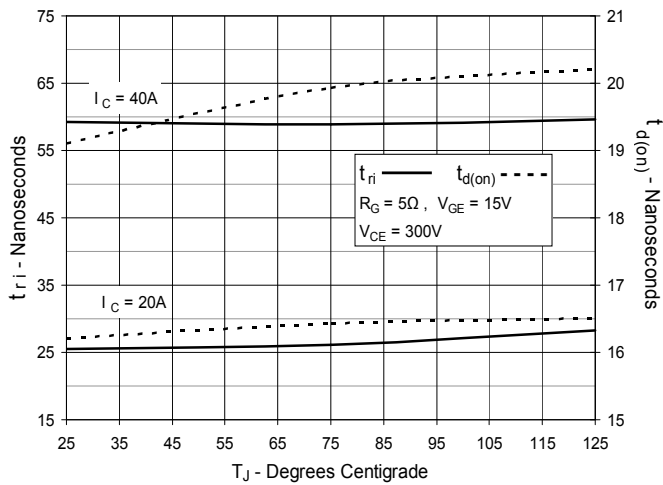



---

Disclaimer Notice - Information furnished is believed to be accurate and reliable. However, users should independently evaluate the suitability of and test each product selected for their own applications. Littelfuse products are not designed for, and may not be used in, all applications. Read complete Disclaimer Notice at [www.littelfuse.com/disclaimer-electronics](http://www.littelfuse.com/disclaimer-electronics).