

## Trench IGBT

## Copack

$V_{CES} = 1200 \text{ V}$

$I_{C25} = 72 \text{ A}$

$V_{CE(sat)} = 2.05 \text{ V}$

## Part number

ITF48IF1200HR

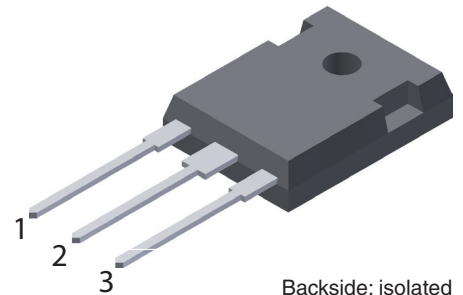

Backside: isolated

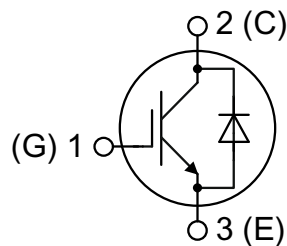

## Features / Advantages:

- Easy paralleling due to the positive temperature coefficient of the on-state voltage
- Fast Trench IGBT
  - very low  $V_{CE(sat)}$
  - short circuit rated for 10  $\mu$ sec.
  - very low gate charge
  - low EMI
  - square RBSOA @  $3x I_C$
- Sonic™ diode
  - fast and soft reverse recovery
  - low operating forward voltage

## Applications:

- Solar inverter
- Medical equipment
- Uninterruptible power supply
- Air-conditioning system
- Welding equipment
- Switched-mode and resonant-mode power supplies
- Inductive heating, cookers
- Pumps, Fans

## Package: ISO247

- Isolation Voltage: 3600 V~
- Industry standard outline
- RoHS compliant
- Epoxy meets UL 94V-0
- Soldering pins for PCB mounting
- Backside: DCB ceramic
- Reduced weight
- Advanced power cycling

## Terms &amp; Conditions of usage

The data contained in this product data sheet is exclusively intended for technically trained staff. The user will have to evaluate the suitability of the product for the intended application and the completeness of the product data with respect to his application. The specifications of our components may not be considered as an assurance of component characteristics. The information in the valid application- and assembly notes must be considered. Should you require product information in excess of the data given in this product data sheet or which concerns the specific application of your product, please contact the sales office, which is responsible for you. Due to technical requirements our product may contain dangerous substances. For information on the types in question please contact the sales office, which is responsible for you. Should you intend to use the product in aviation, in health or life endangering or life support applications, please notify. For any such application we urgently recommend

- to perform joint risk and quality assessments;
- the conclusion of quality agreements;
- to establish joint measures of an ongoing product survey, and that we may make delivery dependent on the realization of any such measures.

IGBT				Ratings		
Symbol	Definitions	Conditions	min.	typ.	max.	
$V_{CE}$	collector emitter voltage				1200	V
$V_{GES}$	max. DC gate voltage				±20	V
$I_{C25}$	collector current				72	A
$I_{C80}$					56	A
$I_{C100}$					48	A
$P_{tot}$	total power dissipation				390	W
$V_{CE(sat)}$	collector emitter saturation voltage	$I_C = 40\text{ A}; V_{GE} = 15\text{ V}$		2.05	2.40	V
				2.70		V
$V_{GE(th)}$	gate emitter threshold voltage	$I_C = 1.5\text{ mA}; V_{GE} = V_{CE}$	5.3	5.8	6.3	V
$I_{CES}$	collector emitter leakage current	$V_{CE} = V_{CES}; V_{GE} = 0\text{ V}$		1.5	0.25	mA
						mA
$I_{GES}$	gate emitter leakage current	$V_{GE} = \pm 20\text{ V}$			600	nA
$Q_{Gon}$	total gate charge	$V_{CE} = 600\text{ V}; V_{GE} = 0/15\text{ V}; I_C = 40\text{ A}$		175		nC
$t_{d(on)}$	turn-on delay time	inductive load $V_{CE} = 600\text{ V}; I_C = 40\text{ A}$ $V_{GE} = 0/15\text{ V}; R_G = 12\ \Omega$		26		ns
$t_r$	current rise time			26		ns
$t_{d(off)}$	turn-off delay time			350		ns
$t_f$	current fall time			110		ns
$E_{on}$	turn-on energy per pulse			3.0		mJ
$E_{off}$	turn-off energy per pulse			2.4		mJ
$E_{rec(off)}$	reverse recovery losses at turn-off			1.1		mJ
<b>RBSOA</b>	reverse bias safe operating area	$V_{GE} = 15\text{ V};$ $V_{CEmax} = 1200\text{ V}$			160	A
$I_{CM}$						
<b>SCSOA</b>	short circuit safe operation area	$V_{CE} = 600\text{ V}; V_{GE} = \pm 15\text{ V}$ $R_G = 12\ \Omega; \text{none repetitive}$			10	$\mu\text{s}$
$t_{SC}$	short circuit duration					
$I_{SC}$	short circuit current			140		A
$R_{thJC}$	thermal resistance junction to case				0.38	K/W
$R_{thJH}$	thermal resistance junction to heatsink	with heat transfer paste (IXYS test setup)		0.6		K/W

Diode						
$V_{RRM}$	max. repetitive reverse voltage				1200	V
$I_{F25}$	forward current				67	A
$I_{F80}$					50	A
$I_{F100}$					43	A
$V_F$	forward voltage	$I_F = 30\text{ A}$			2.20	V
					1.95	V
$Q_{rr}$	reverse recovery charge	$V_R = 600\text{ V}$ $-di_F/dt = -1800\text{ A}/\mu\text{s}$ $I_F = 40\text{ A}; V_{GE} = 0\text{ V}$		3.8		$\mu\text{C}$
$I_{RM}$	max. reverse recovery current			55		A
$t_{rr}$	reverse recovery time			250		ns
$E_{rec}$	reverse recovery losses			1.1		mJ
$R_{thJC}$	thermal resistance junction to case				0.7	K/W
$R_{thJH}$	thermal resistance junction to heatsink	with heat transfer paste (IXYS test setup)		1.1		K/W

Package ISO247				Ratings			
Symbol	Definitions	Conditions		min.	typ.	max.	
$I_{RMS}$	RMS current	per terminal				50	A
$T_{stg}$	storage temperature			-40		150	°C
$T_{op}$	operation temperature			-40		150	°C
$T_{VJ}$	virtual junction temperature			-40		175	°C
<b>Weight</b>					6		g
$M_D$	mounting torque			0.8		1.2	Nm
$F_C$	mounting force with clip			40		120	N
$d_{Spp/App}$	creepage distance on surface /	terminal to terminal		2.7			mm
$d_{Spb/Appb}$	striking distance through air	terminal to backside		4.1			mm
$V_{ISOL}$	isolation voltage	t = 1 second t = 1 minute	50/60 Hz; RMS; $I_{ISOL} < 1$ mA		3600 3000		V V

### Product Marking

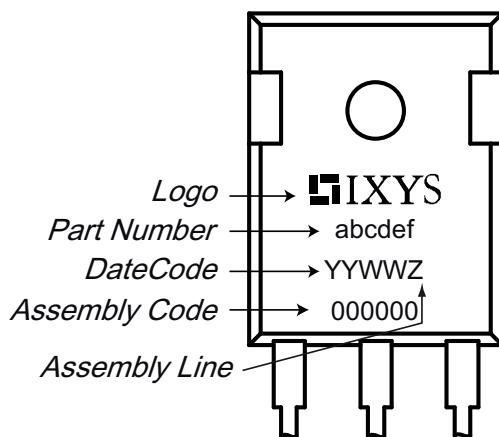

### Part number

I = IGBT  
 T = IGBT Trench  
 F = Fast  
 48 = Current Rating [A]  
 IF = Copack  
 1200 = Reverse Voltage [V]  
 HR = ISO247 (3)

Ordering	Part Name	Marking on Product	Delivering Mode	Base Qty	Ordering Code
Standard	ITF48IF1200HR	ITF48IF1200HR	Tube	30	517181

### Equivalent Circuits for Simulation \*on die level $T_{VJ} = 175^{\circ}C$

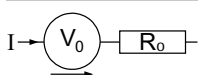

		IGBT	Diode	
$V_{0\ max}$	threshold voltage	0.88	1.2	V
$R_{0\ max}$	slope resistance *	58	30	mΩ

## Outlines ISO247

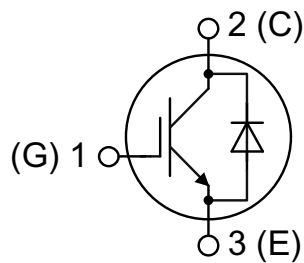
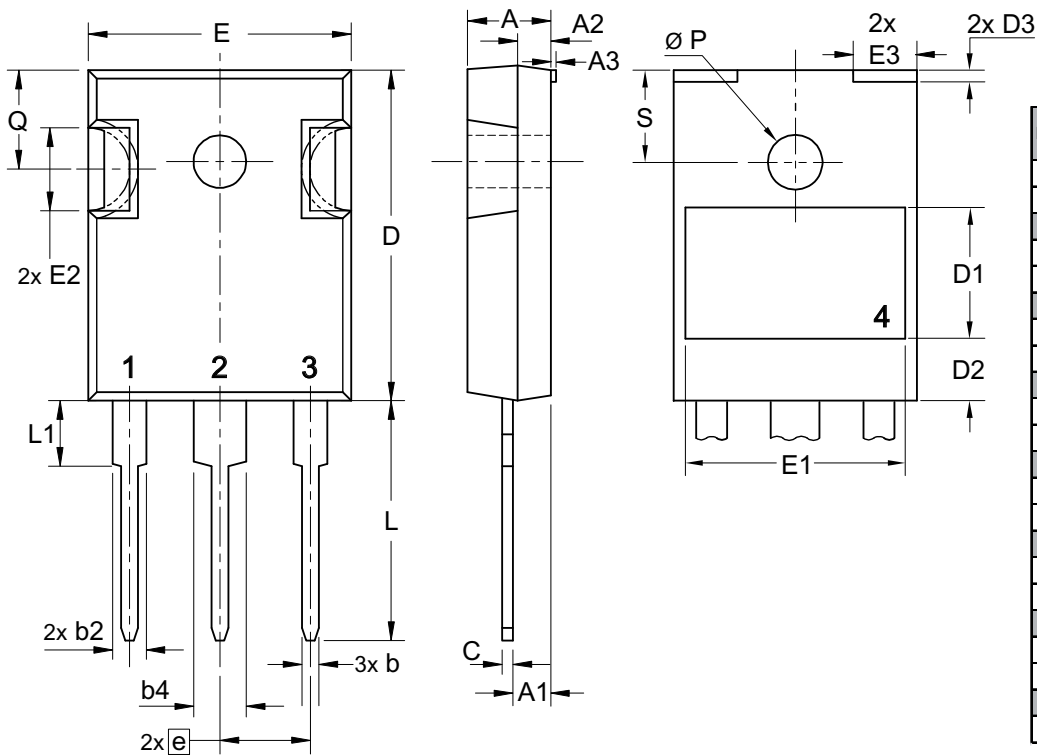

## IGBT

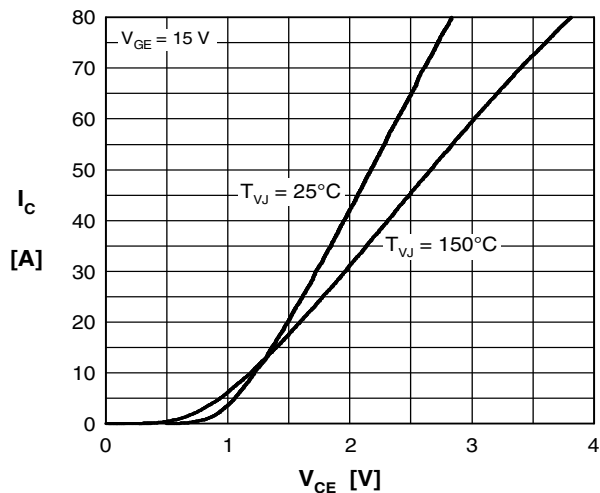

Fig. 1 Typ. output characteristics

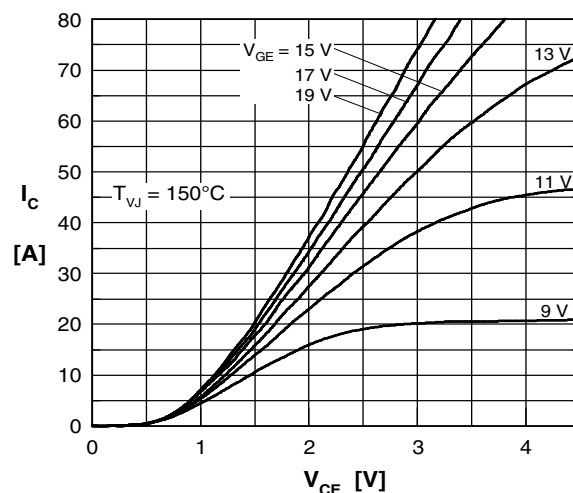

Fig. 2 Typ. output characteristics

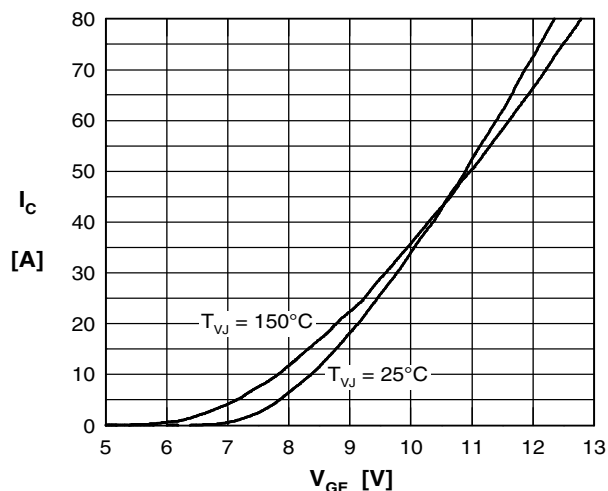

Fig. 3 Typ. transfer characteristics

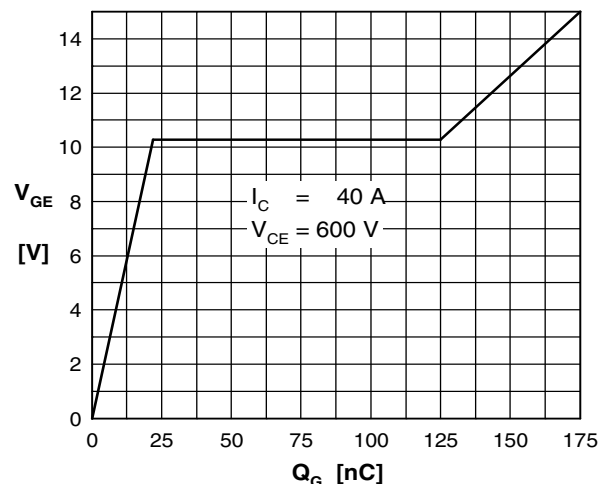

Fig. 4 Typ. turn-on gate charge

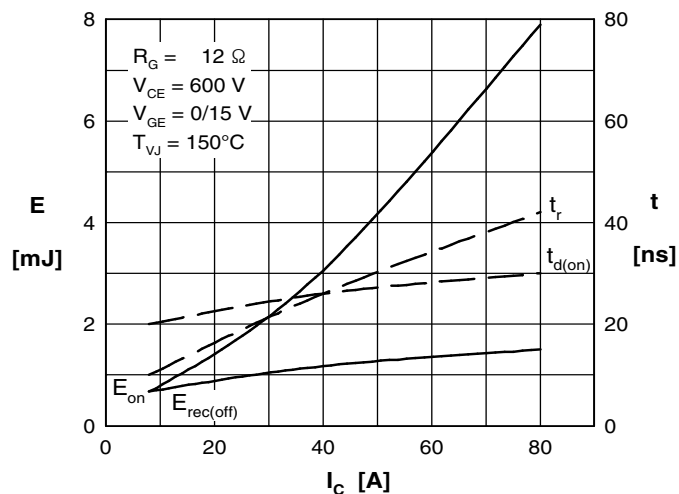

Fig. 5 Typ. turn-on energy & switching times versus collector current

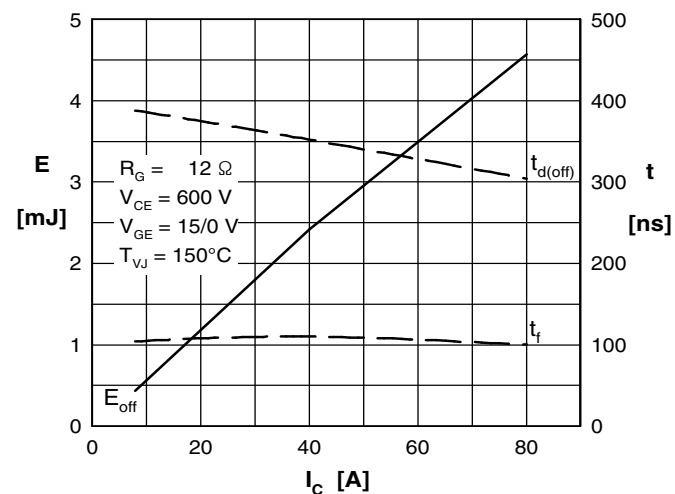

Fig. 6 Typ. turn-off energy & switching times versus collector current

**IGBT**

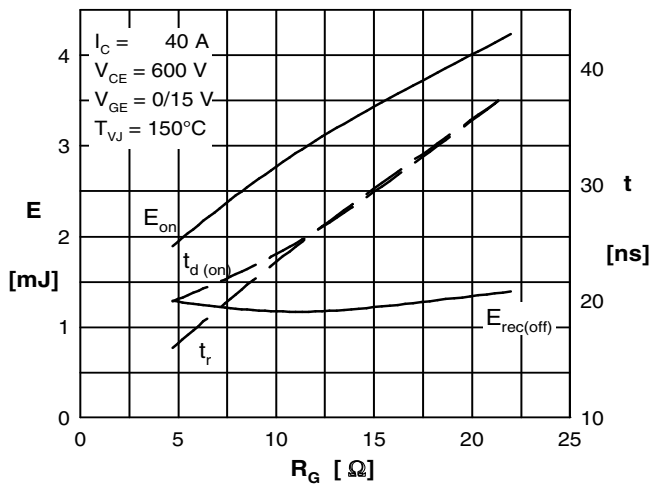

Fig. 7 Typ. turn-on energy and switching times versus gate resistor

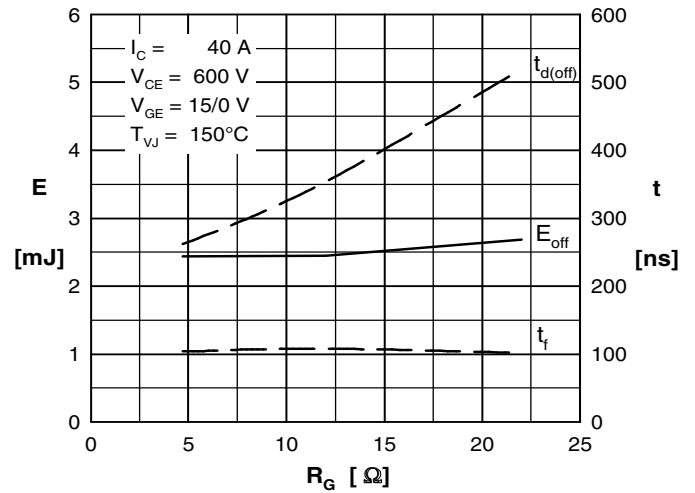

Fig. 8 Typ. turn-off energy and switching times versus gate resistor

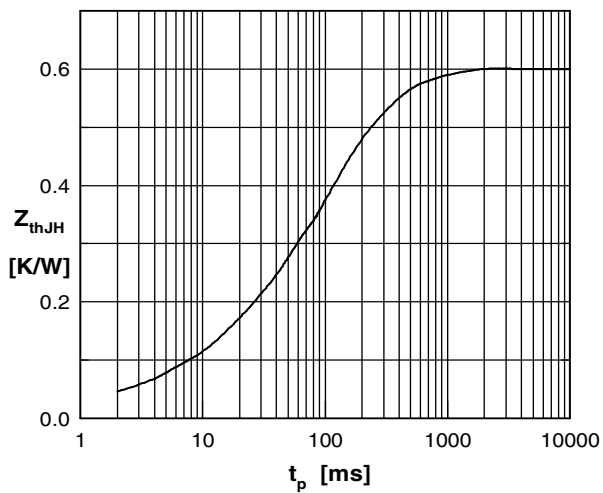

Fig. 9 Typ. transient thermal impedance

## DIODE

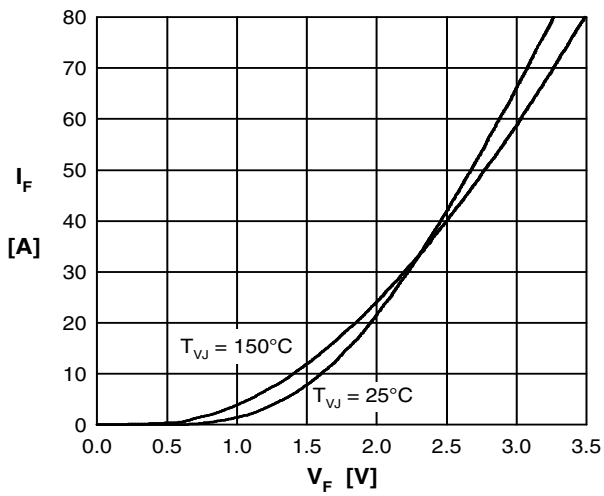

Fig. 10 Typ. forward characteristics

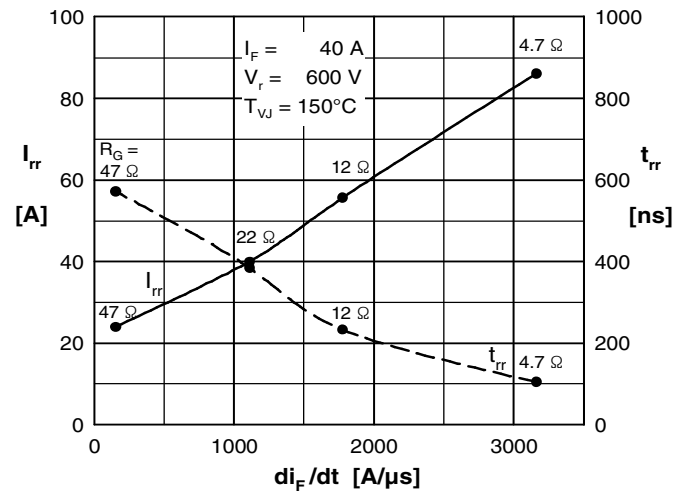

Fig. 11 Typ. reverse recovery characteristics

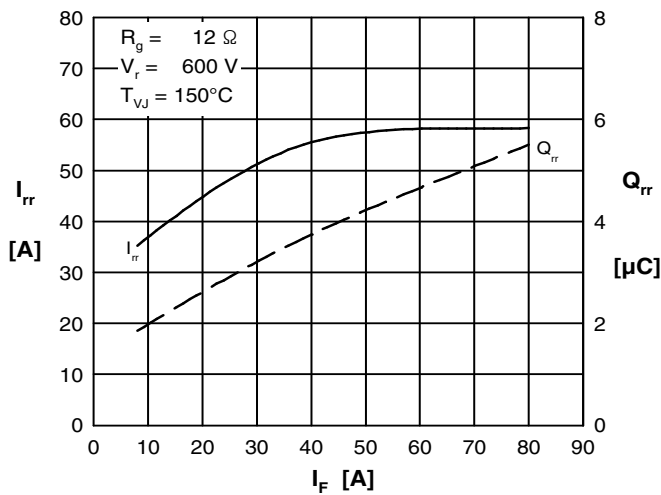

Fig. 12 Typ. reverse recovery characteristics

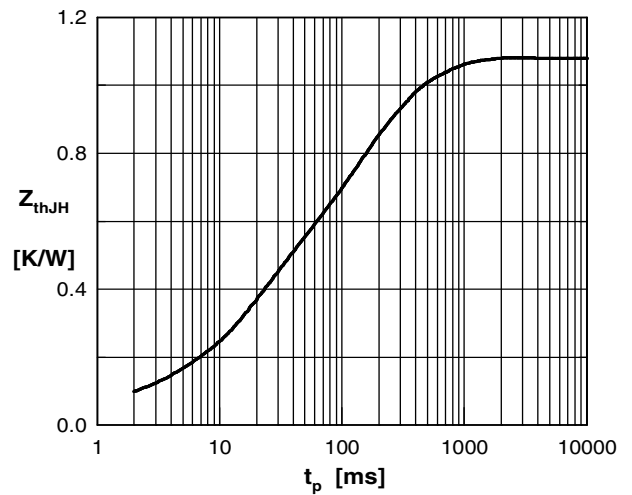

Fig. 13 Typ. transient thermal impedance