

**LinearL2™ Power  
MOSFET w/Extended  
FBSOA**
**IXTT140N075L2HV  
IXTH140N075L2**
 $V_{DSS} = 75V$   
 $I_{D25} = 140A$   
 $R_{DS(on)} \leq 11m\Omega$ 

 N-Channel Enhancement Mode  
 Avalanche Rated

Symbol	Test Conditions	Maximum Ratings	
$V_{DSS}$	$T_J = 25^\circ C$ to $150^\circ C$	75	V
$V_{DGR}$	$T_J = 25^\circ C$ to $150^\circ C$ , $R_{GS} = 1M\Omega$	75	V
$V_{GSS}$	Continuous	$\pm 20$	V
$V_{GSM}$	Transient	$\pm 30$	V
$I_{D25}$	$T_C = 25^\circ C$	140	A
$I_{DM}$	$T_C = 25^\circ C$ , Pulse Width Limited by $T_{JM}$	500	A
$I_A$	$T_C = 25^\circ C$	140	A
$E_{AS}$	$T_C = 25^\circ C$	1.5	J
$P_D$	$T_C = 25^\circ C$	540	W
$T_J$		-55...+150	$^\circ C$
$T_{JM}$		150	$^\circ C$
$T_{stg}$		-55...+150	$^\circ C$
$T_L$	Maximum Lead Temperature for Soldering	300	$^\circ C$
$T_{SOLD}$	1.6 mm (0.062in.) from Case for 10s	260	$^\circ C$
$M_d$	Mounting Torque (TO-247)	1.13/10	Nm/lb.in
<b>Weight</b>	TO-268HV	4	g
	TO-247	6	g

TO-268HV (IXTT)

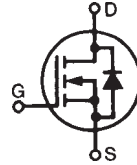
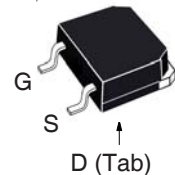

TO-247 (IXTH)

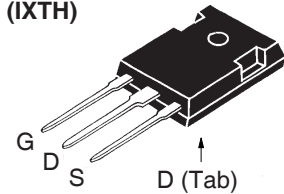
 G = Gate      D = Drain  
 S = Source    Tab = Drain

**Features**

- Designed for Linear Operation
- International Standard Packages
- Avalanche Rated
- Guaranteed FBSOA at  $75^\circ C$

**Advantages**

- Easy to Mount
- Space Savings
- High Power Density

**Applications**

- Solid State Circuit Breakers
- Soft Start Controls
- Linear Amplifiers
- Programmable Loads
- Current Regulators

Symbol	Test Conditions ( $T_J = 25^\circ C$ , Unless Otherwise Specified)	Characteristic Values		
		Min.	Typ.	Max.
$BV_{DSS}$	$V_{GS} = 0V$ , $I_D = 250\mu A$	75		V
$V_{GS(th)}$	$V_{DS} = V_{GS}$ , $I_D = 250\mu A$	2.0		4.5 V
$I_{GSS}$	$V_{GS} = \pm 20V$ , $V_{DS} = 0V$			$\pm 100$ nA
$I_{DSS}$	$V_{DS} = V_{DSS}$ , $V_{GS} = 0V$ $T_J = 125^\circ C$			5 $\mu A$
				25 $\mu A$
$R_{DS(on)}$	$V_{GS} = 10V$ , $I_D = 0.5 \cdot I_{D25}$ , Note 1			11 m $\Omega$

Symbol	Test Conditions ( $T_J = 25^\circ\text{C}$ , Unless Otherwise Specified)	Characteristic Values		
		Min.	Typ.	Max.
$g_{fs}$	$V_{DS} = 10\text{V}$ , $I_D = 60\text{A}$ , Note 1	50	65	80 S
$R_{Gi}$	Gate Input Resistance		1.24	$\Omega$
$C_{iss}$	$V_{GS} = 0\text{V}$ , $V_{DS} = 25\text{V}$ , $f = 1\text{MHz}$		9300	pF
$C_{oss}$			2190	pF
$C_{rss}$			750	pF
$t_{d(on)}$	<b>Resistive Switching Times</b> $V_{GS} = 10\text{V}$ , $V_{DS} = 0.5 \cdot V_{DSS}$ , $I_D = 0.5 \cdot I_{D25}$ $R_G = 2\Omega$ (External)		26	ns
$t_r$			83	ns
$t_{d(off)}$			100	ns
$t_f$			33	ns
$Q_{g(on)}$	$V_{GS} = 10\text{V}$ , $V_{DS} = 0.5 \cdot V_{DSS}$ , $I_D = 0.5 \cdot I_{D25}$		275	nC
$Q_{gs}$			40	nC
$Q_{gd}$			108	nC
$R_{thJC}$				0.23 $^\circ\text{C/W}$
$R_{thCS}$	TO-247	0.21		$^\circ\text{C/W}$

### Safe Operating Area Specification

Symbol	Test Conditions	Characteristic Values		
		Min.	Typ.	Max.
<b>SOA</b>	$V_{DS} = 75\text{V}$ , $I_D = 4.35\text{A}$ , $T_C = 75^\circ\text{C}$ , $T_p = 5\text{s}$	326		W

### Source-Drain Diode

Symbol	Test Conditions ( $T_J = 25^\circ\text{C}$ , Unless Otherwise Specified)	Characteristic Values		
		Min.	Typ.	Max.
$I_S$	$V_{GS} = 0\text{V}$			140 A
$I_{SM}$	Repetitive, pulse width limited by $T_{JM}$			560 A
$V_{SD}$	$I_F = 100\text{A}$ , $V_{GS} = 0\text{V}$ , Note 1			1.4 V
$t_{rr}$	$I_F = 70\text{A}$ , $-di/dt = 100\text{A}/\mu\text{s}$ , $V_R = 37.5\text{V}$ , $V_{GS} = 0\text{V}$		200	ns
$I_{RM}$			14.0	A
$Q_{RM}$			1.4	$\mu\text{C}$

Note: 1. Pulse test,  $t \leq 300\mu\text{s}$ ; duty cycle,  $d \leq 2\%$ .

### **PRELIMINARY TECHNICAL INFORMATION**

The product presented herein is under development. The Technical Specifications offered are derived from a subjective evaluation of the design, based upon prior knowledge and experience, and constitute a "considered reflection" of the anticipated result. IXYS reserves the right to change limits, test conditions, and dimensions without notice.

IXYS reserves the right to change limits, test conditions, and dimensions.

IXYS MOSFETs and IGBTs are covered by one or more of the following U.S. patents:

4,835,592	4,931,844	5,049,961	5,237,481	6,162,665	6,404,065 B1	6,683,344	6,727,585	7,005,734 B2	7,157,338B2
4,860,072	5,017,508	5,063,307	5,381,025	6,259,123 B1	6,534,343	6,710,405 B2	6,759,692	7,063,975 B2	
4,881,106	5,034,796	5,187,117	5,486,715	6,306,728 B1	6,583,505	6,710,463	6,771,478 B2	7,071,537	

**Fig. 1. Output Characteristics @  $T_J = 25^\circ\text{C}$**

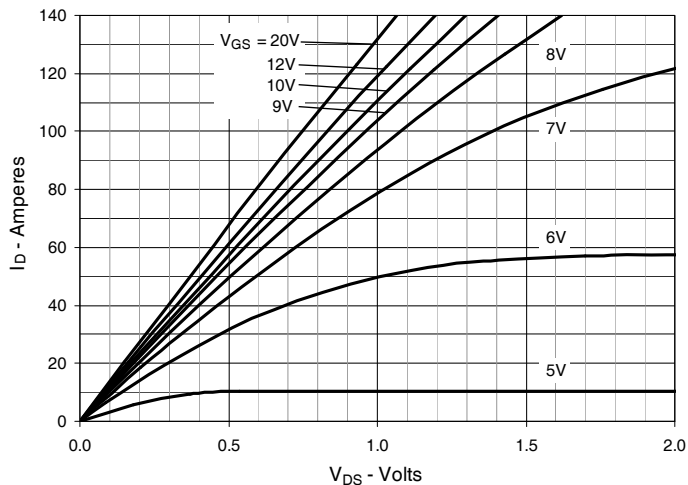

**Fig. 2. Extended Output Characteristics @  $T_J = 25^\circ\text{C}$**

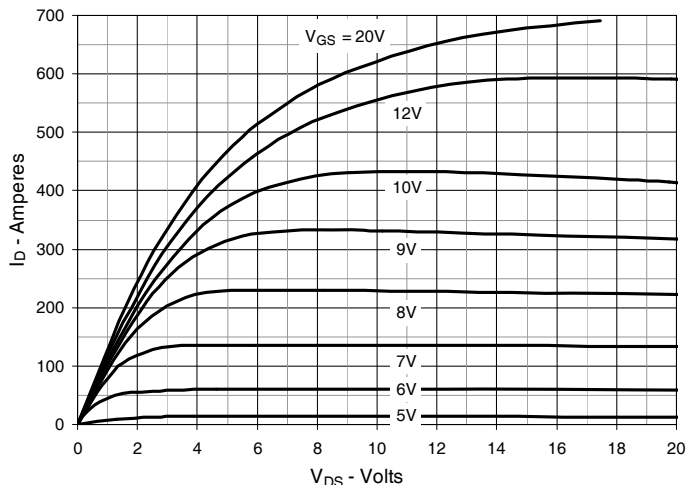

**Fig. 3. Output Characteristics @  $T_J = 125^\circ\text{C}$**

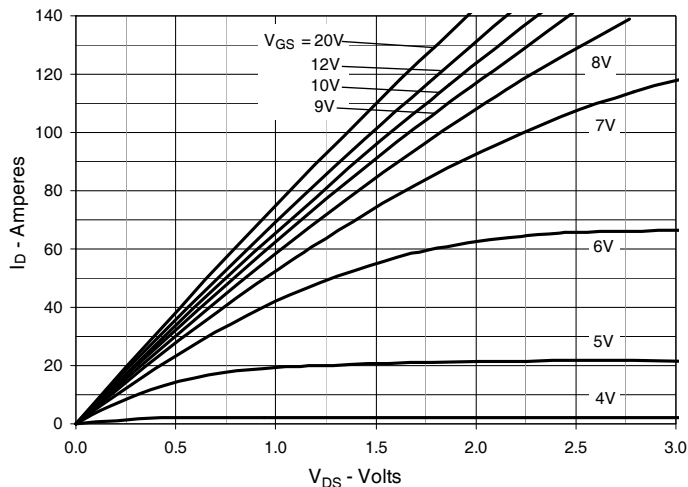

**Fig. 4.  $R_{DS(on)}$  Normalized to  $I_D = 70\text{A}$  Value vs. Junction Temperature**

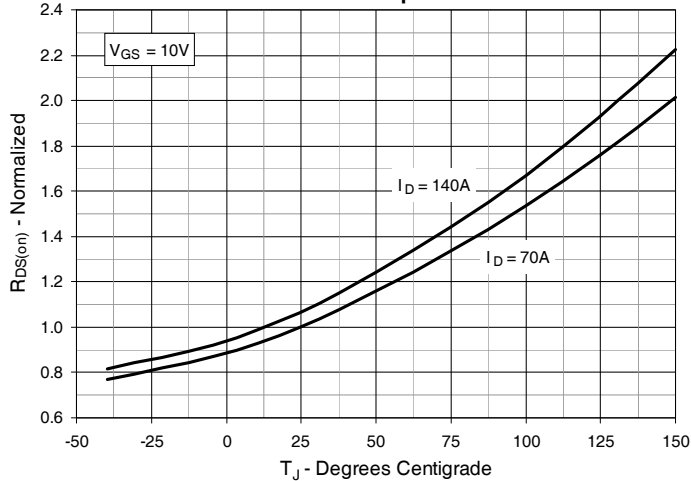

**Fig. 5.  $R_{DS(on)}$  Normalized to  $I_D = 70\text{A}$  Value vs. Drain Current**

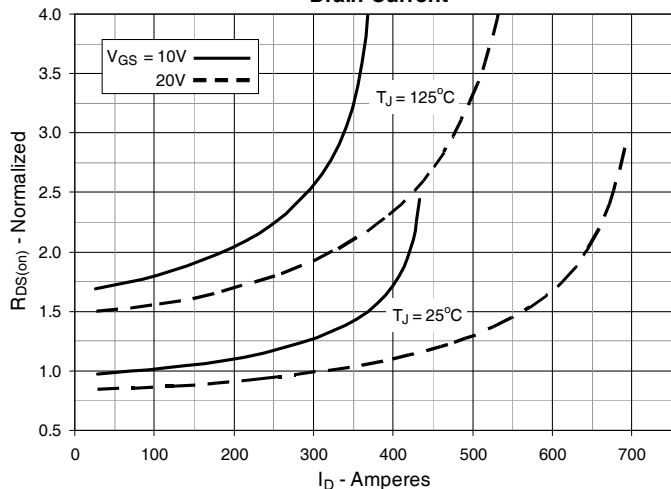

**Fig. 6. Maximum Drain Current vs. Case Temperature**

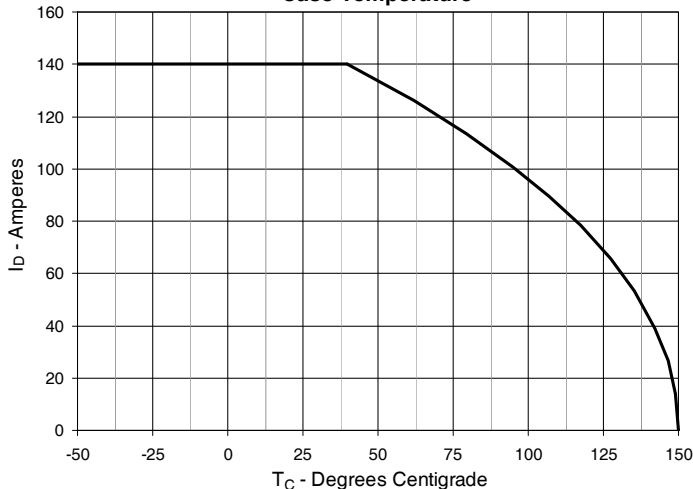

**Fig. 7. Input Admittance**

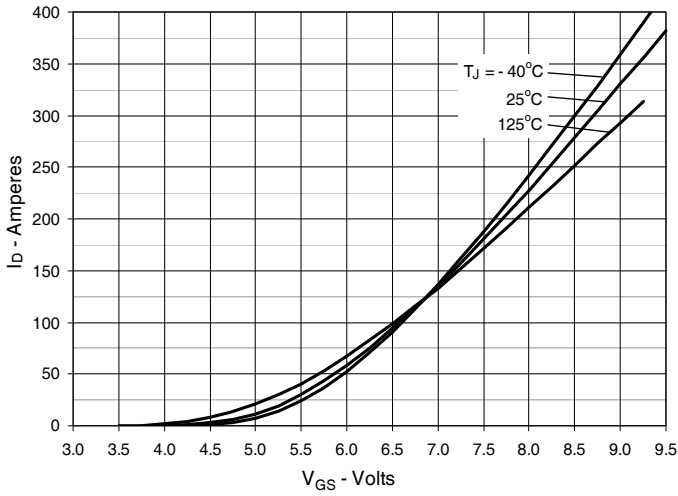

**Fig. 8. Transconductance**

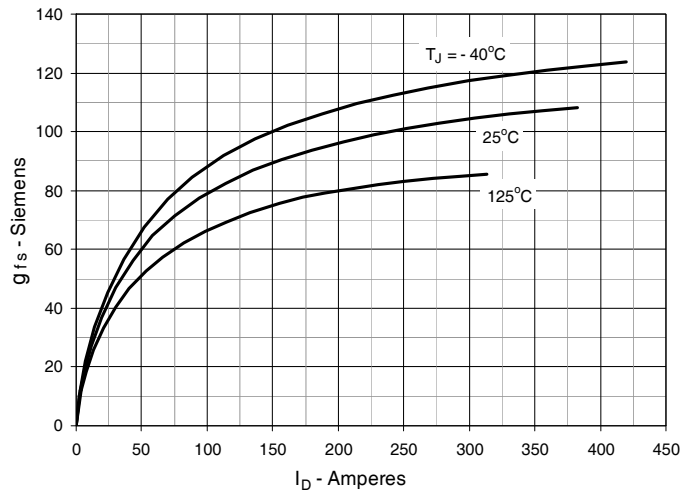

**Fig. 9. Forward Voltage Drop of Intrinsic Diode**

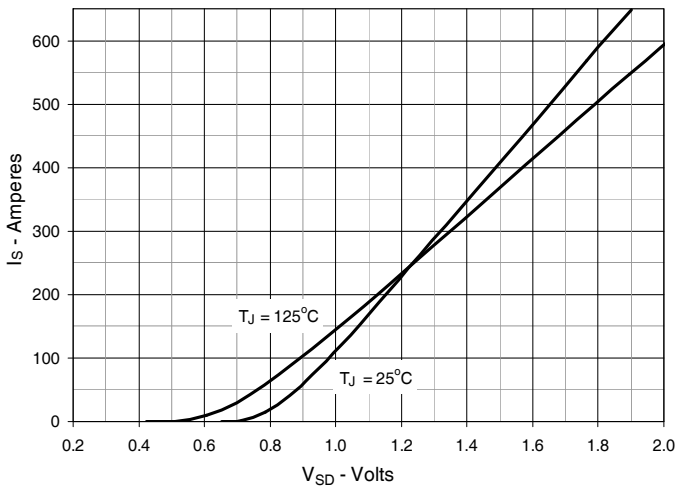

**Fig. 10. Gate Charge**

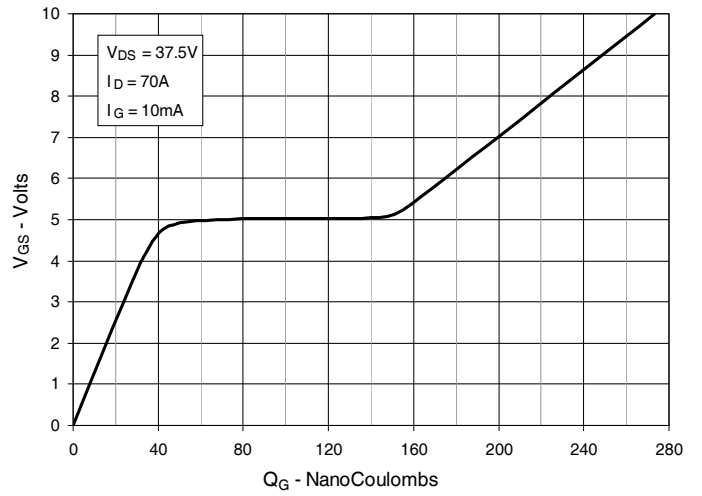

**Fig. 11. Capacitance**

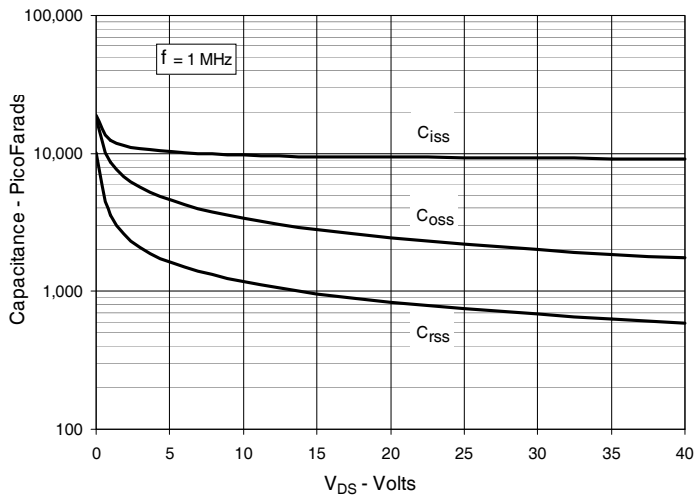

**Fig. 12. Maximum Transient Thermal Impedance**

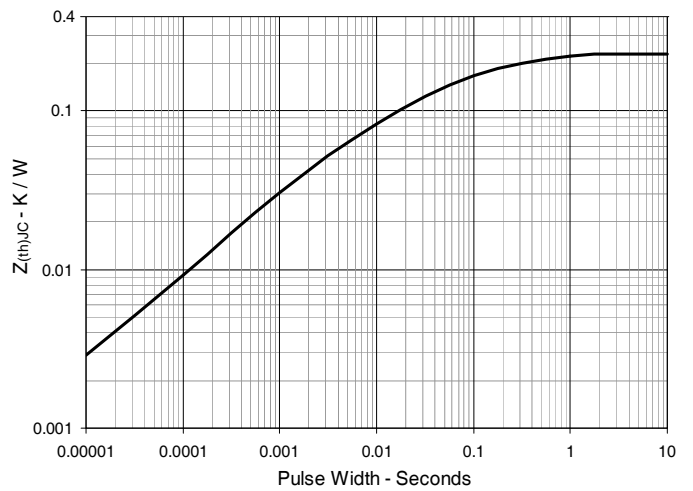

Fig. 13. Forward-Bias Safe Operating Area  
@  $T_C = 25^\circ\text{C}$

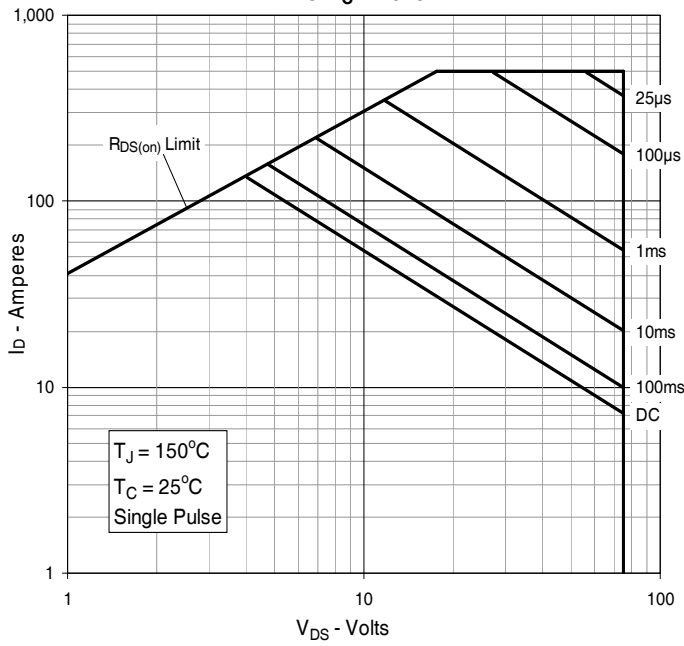
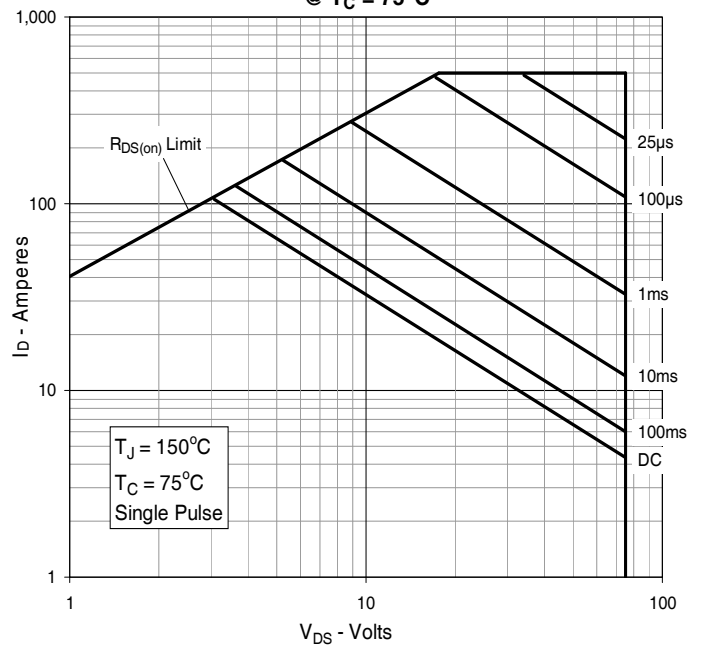
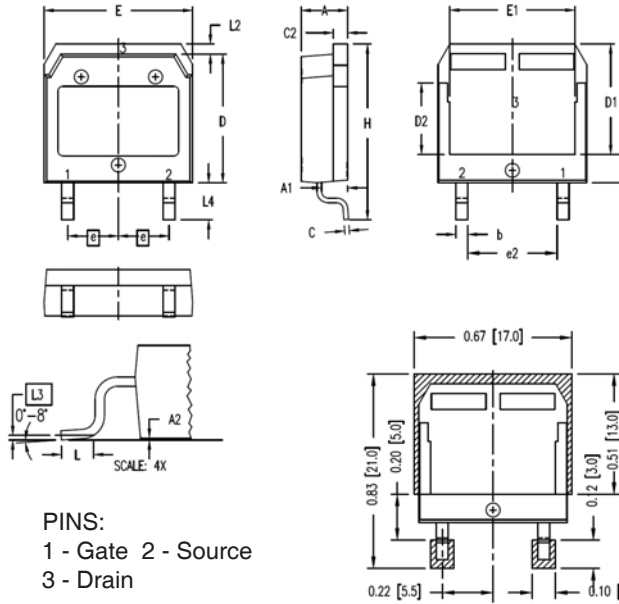
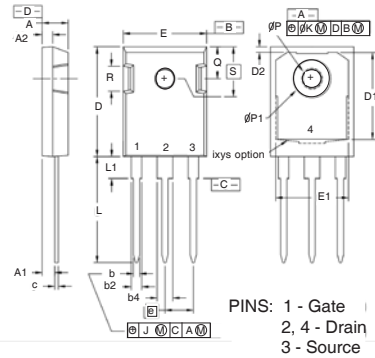

Fig. 14. Forward-Bias Safe Operating Area  
@  $T_C = 75^\circ\text{C}$



**TO-268HV Outline**

SYM	INCHES		MILLIMETER	
	MIN	MAX	MIN	MAX
A	.193	.201	4.90	5.10
A1	.106	.114	2.70	2.90
A2	.001	.010	0.02	0.25
b	.045	.057	1.15	1.45
C	.016	.026	0.40	0.65
C2	.057	.063	1.45	1.60
D	.543	.551	13.80	14.00
D1	.465	.476	11.80	12.10
D2	.295	.307	7.50	7.80
D3	.114	.126	2.90	3.20
E	.624	.632	15.85	16.05
E1	.524	.535	13.30	13.60
e	.215 BSC		5.45 BSC	
(e2)	.374	.386	9.50	9.80
H	.736	.752	18.70	19.10
L	.067	.079	1.70	2.00
L2	.039	.045	1.00	1.15
L3	.010 BSC		0.25 BSC	
L4	.150	.161	3.80	4.10

**TO-247 Outline**

SYM	INCHES		MILLIMETERS	
	MIN	MAX	MIN	MAX
A	.190	.205	4.83	5.21
A1	.090	.100	2.29	2.54
A2	.075	.085	1.91	2.16
b	.045	.055	1.14	1.40
b2	.075	.087	1.91	2.20
b4	.115	.126	2.92	3.20
C	.024	.031	0.61	0.80
D	.819	.840	20.80	21.34
D1	.650	.690	16.51	17.53
D2	.035	.050	0.89	1.27
E	.620	.635	15.75	16.13
E1	.545	.565	13.84	14.35
e	.215 BSC		5.45 BSC	
J	-.010	.010	-.25	0.25
K	-.025	.025	-.64	0.64
L	.780	.810	19.81	20.57
L1	.150	.170	3.81	4.32
øP	.140	.144	3.55	3.65
øP1	.275	.290	6.99	7.37
Q	.220	.244	5.59	6.20
R	.170	.190	4.32	4.83
S	.242 BSC		6.15 BSC	



---

Disclaimer Notice - Information furnished is believed to be accurate and reliable. However, users should independently evaluate the suitability of and test each product selected for their own applications. Littelfuse products are not designed for, and may not be used in, all applications. Read complete Disclaimer Notice at [www.littelfuse.com/disclaimer-electronics](http://www.littelfuse.com/disclaimer-electronics).