





322/332 Series Lead-free 3AB, Very Fast-acting Fuse



Agency Approvals

Agency	Agency File Number	Ampere Range	Series
	E10480	12A - 30A	322
	E10480	1A - 10A	332
	NBK080306-JP1021A NBK080306-JP1021B	1-5A 6-10A	332
	N/A	1A - 30A	322/332

Description

The 322 and 332 Series are 3AB Very Fast-Acting fuses for protection of Silicon Controlled Rectifiers and similar solid-state devices.

Features

- In accordance with UL Standard 248-14
- Available in cartridge format only
- RoHS compliant and Lead-free





Applications

Used as supplementary protection in appliance or utilization equipment to provide individual protection for components or internal circuits.

Electrical Characteristics for Series

% of Ampere Rating	Ampere Rating	Opening Time
100%	1 – 30	4 hours, Minimum
250%	1 – 10	.2 second, Maximum
	12 – 30	1 second, Maximum.

Electrical Characteristic Specifications by Item

Amp Code	Ampere Rating (A)	Voltage Rating (V)	Interrupting Rating	Nominal Cold Resistance (Ohms)	Nominal Melting I ² t (A ² sec)	Agency Approvals			
									
001.	1	250	100A@250Vac 100A@125Vdc 200A@72Vdc	0.0927	0.146	x		x	x
1.25	1.25	250		0.0804	0.204	x		x	x
002.	2	250		0.0416	0.790	x		x	x
003.	3	250		0.0245	2.760	x		x	x
004.	4	250		0.0179	3.360	x		x	x
005.	5	250		0.0128	6.250	x		x	x
006.	6	250		0.0117	8.208	x		x	x
007.	7	250		0.0108	10.58	x		x	x
008.	8	250		0.0088	16.45	x		x	x
009.	9	250		0.0077	20.66	x		x	x
010.	10	250	0.0073	24.0	x		x	x	
012.	12	65	200A@65Vac 1000A@65Vdc	0.0057	38.0		x		x
015.	15	65		0.0043	59.0		x		x
020.	20	65		0.0034	192.0		x		x
025.*	25	65		0.0029	325.0		x		x
030.*	30	65		0.0023	540.0		x		x

* Ratings from 1A to 10A are available for 332 series

* Ratings from 12A to 30A are available for 322 series, these ratings are RoHS compliant version.

Temperature Re-rating Curve

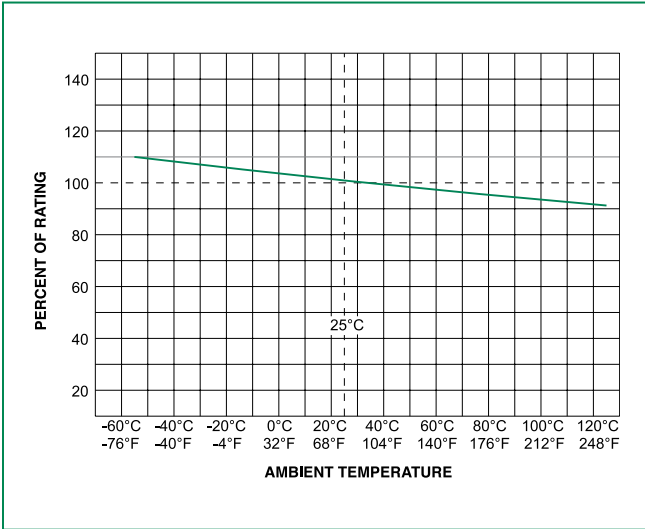

Note:
Re-rating depicted in this curve is in addition to the industry practice derating of 25% for continuous operation.

Average Time Current Curves

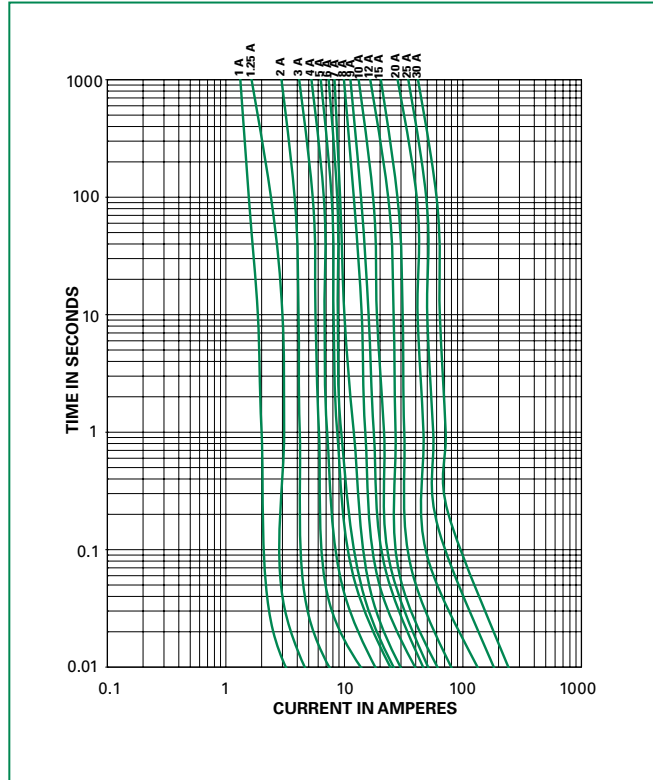

Product Characteristics

Materials	Body: Ceramic Cap: Nickel-plated brass
Terminal Strength	MIL-STD-202, Method 211, Test Condition A
Solderability	MIL-STD-202 Method 208
Product Marking	Cap1: Brand logo, current and voltage ratings Cap2: Series and agency approval marks

Operating Temperature	-55°C to +125°C
Thermal Shock	MIL-STD-202, Method 107, Test Condition B: (5 cycles -65°C to +125°C)
Vibration	MIL-STD-202, Method 201
Humidity	MIL-STD-202, Method 103, Test Condition A: High RH (95%) and Elevated temperature (40°C) for 240 hours
Salt Spray	MIL-STD-202, Method 101, Test Condition B

Dimensions

Measurements displayed in millimeters (inches)

322 000P / 332 000P Series (cartridge)

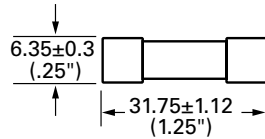

Part Numbering System

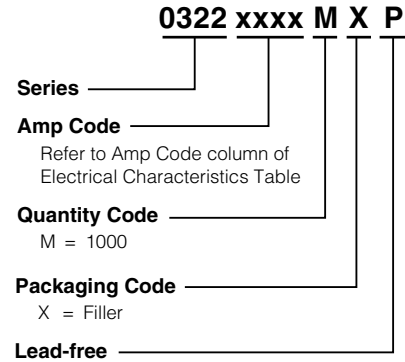

Packaging

Packaging Option	Packaging Specification	Quantity	Quantity & Packaging Code	Reel Size
322 Series				
Bulk	N/A	1000	MX	N/A
Bulk	N/A	100	HX	N/A
332 Series				
Bulk	N/A	100	HX	N/A
Bulk	N/A	1000	MX	N/A

Additional Information



Datasheet
322 Series



Resources
322 Series



Samples
322 Series



Datasheet
332 Series



Resources
332 Series



Samples
332 Series



Accessories
322 & 332 Series

For recommended fuse accessories for this product series, see '[Recommended Accessories](#)' section.

Recommended Accessories

Accessory Type	Series	Description	Max Application Voltage	Max Application Amperage
Holder	155100	Twist-Lock In-Line Fuseholder	32	20
	342	Traditional Panel Mount Fuseholder	250	20
	346	Panel Mount Flip-Top Shock-Safe Fuseholder	250	15
	345	Shock-Safe Fuseholder with PC Mount, Solder Mount and Panel Mount options	250	20
Block	354	Low Profile OMNI-BLOK [®] Fuse Block	600	30
	359	High Current Screw Terminal Fuse Block		30
Clip	122	High Current Traditional PC Board Fuse Clip	1000	30
	101	Rivet/Eyelet Type Fuse Clip	1000	15

Notes:

- Do not use in applications above rating.
- Please refer to fuseholder data sheet for specific re-rating information.
- Please contact factory for applications greater than the max voltage and amperage shown.

Disclaimer Notice - Information furnished is believed to be accurate and reliable. However, users should independently evaluate the suitability of and test each product selected for their own applications. Littelfuse products are not designed for, and may not be used in, all applications. Read complete Disclaimer Notice at: www.littelfuse.com/disclaimer-electronics.