

SL1002A Series



**Agency Approvals**

| AGENCY | AGENCY FILE NUMBER |
|--------|--------------------|
|        | E128662            |

**2 Electrode GDT Graphical Symbol**



**Additional Information**



Datasheet



Resources



Samples

**Description**

The Broadband Optimized™ SL1002A series has been especially developed for use in broadband equipment. Special design features provide high levels of protection against fast rising transients in the 100V/μs to 1kV/μs range usually caused by lightning disturbances. These devices have ultra low capacitance (typically 1.2pF or less) and present insignificant signal losses up to 1.5GHz. These devices are extremely robust and are able to divert a 5000A pulse without destruction. For AC Power Cross of long duration, overcurrent protection is recommended.

**Features**

- RoHS compliant/Lead-free
- Ultra low insertion loss
- Surface mountable
- 5kA surge capability tested with 8/20μS–Pulse as defined by IEC 61000-4-5
- Excellent response to fast rising transients
- Can be used to meet Telcordia GR1089 without series resistance
- 10/700 6kV capability, as per ITU-T Rec. K.21, enhanced test level
- 2000 A 2/10μs surge rating
- Meet FCC part 68 10/160μs waveform, 200A test and 10/560μs waveform 100A test
- Halogen-free

**Applications**

- Broadband equipment
- ADSL equipment
- XDSL equipment
- Satellite and CATV equipment
- General telecom equipment

### Electrical Characteristics

| Part Number  | Device Specifications (at 25°C)                   |     |     |   |  |                                |                                   |   | Life Ratings                       |  |   |                                  |  |             |
|--------------|---|-----|-----|---|--|--------------------------------|-----------------------------------|---|------------------------------------|--|---|----------------------------------|--|-------------|
|              | DC Breakdown in Volts <sup>1,2</sup><br>(@100V/s) |     |     | Impulse Breakdown in Volts <sup>3,4</sup><br>(@100V/μs) | Impulse Breakdown in Volts <sup>3,4</sup><br>(@1kV/μs) | Insulation Resistance          | Capacitance<br>(@1MHz<br>0V Bias) | Arc Voltage<br>(on state<br>voltage)<br>@1Amp Min | Surge Life<br>(@100A<br>10/1000μs) | Nominal Impulse Discharge Current<br>(@20μs) | Nominal AC Discharge Current<br>(10x1s<br>@50-60Hz) | DC Holdover Voltage <sup>5</sup> | Max Impulse Discharge Current<br>(1 Application) |             |
|              | MIN   | TYP | MAX | MAX   |  | MIN                            | MAX                               | TYP   |                                    |  |   | TYP                              | @ 2/10 μs  | @ 10/350 μs |
| SL1002A075   | 60  | 75  | 90  | 400   | 650  | 10 <sup>9</sup> Ω<br>(at 50V)  | 1.2 pF                            | ~15 V   | 300 shots <sup>6</sup>             | 10 shots <sup>7</sup><br>(@ 5kA)             | 5 A   | 50 V                             | 2 kA   | 1.5 kA      |
| SL1002A090   | 72  | 90  | 108 |   |  |                                |                                   |   |                                    |  |   | 135 V                            |  |             |
| SL1002A230   | 184   | 230 | 276 | 600   | 700  | 10 <sup>9</sup> Ω<br>(at 100V) | 1.2 pF                            | ~15 V   | 300 shots <sup>6</sup>             | 10 shots <sup>7</sup><br>(@ 5kA)             | 5 A   | 135 V                            | 2 kA   | 1.5 kA      |
| SL1002A250   | 200   | 250 | 300 |   |  |                                |                                   |   |                                    |  |   |                                  |  |             |
| SL1002A260   | 210   | 260 | 310 |   |  |                                |                                   |   |                                    |  |   |                                  |  |             |
| SL1002A350   | 280   | 350 | 420 |   |  |                                |                                   |   |                                    |  |   |                                  |  |             |
| SL1002A470   | 376   | 470 | 564 | 900   | 1000   | 10 <sup>9</sup> Ω<br>(at 500V) | 1.2 pF                            | ~15 V   | 300 shots <sup>6</sup>             | 10 shots <sup>7</sup><br>(@ 5kA)             | 5 A   | 135 V                            | 2 kA   | 1.5 kA      |
| SL1002A600   | 480   | 600 | 720 |   |  |                                |                                   |   |                                    |  |   |                                  |  |             |
| SL1002A600SP | 570   | 600 | 780 | 1200  | 1300   | 10 <sup>9</sup> Ω<br>(at 500V) | 1.2 pF                            | ~15 V   | 300 shots <sup>6</sup>             | 10 shots <sup>7</sup><br>(@ 5kA)             | 5 A   | 135 V                            | 2 kA   | 1.5 kA      |

Notes:

- At delivery AQL 0.65 level II, DIN ISO 2859
- In ionized mode
- In ionized mode, tested according to ITU-T Rec. K.12
- Comparable to the silicon measurement Switching Voltage (Vs)
- Reference REA PE-80, 0.2A. Tested to ITU-T Rec. K.12 and REA PE-80 < 150 msecs.
- 300 Applications [150(+) & 150(-)]
- 10x[5x (+) & 5x (-)] Applications

### Product Characteristics

|                        |  |
|------------------------|--|
| <b>Materials</b>       | <b>Construction</b> = Ceramic Insulator<br><b>Device Finish</b> = Dull Tin-plated 17.5 +/-12.5 microns |
| <b>Product Marking</b> | Littelfuse 'LF' Mark, voltage and date code  |

|  |                 |
|--|-----------------|
| <b>Glow to Arc Transition Current</b>      | < 0.5 Amps      |
| <b>Glow Voltage</b>                        | ~60 - 140 Volts |
| <b>Storage and Operational Temperature</b> | -40 to +90°C    |

### Voltage vs. Time Characteristics

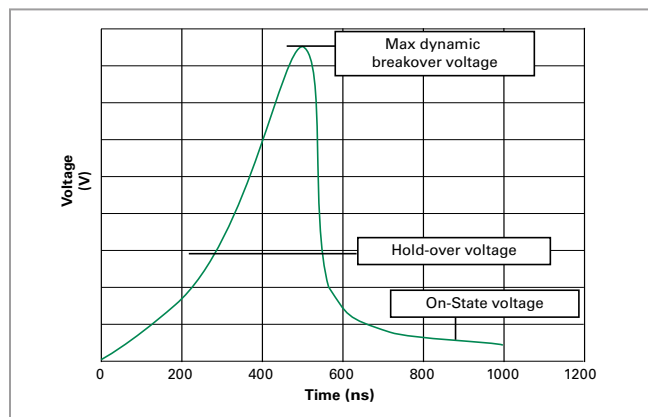

**Insertion Loss Characteristics**

**Typical Insertion Loss Characteristics (90V)**

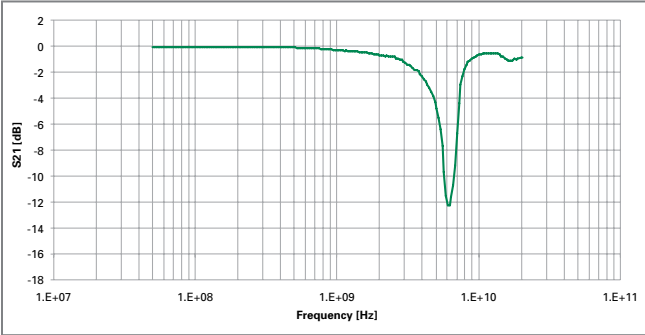

**Typical Insertion Loss Characteristics (600V)**

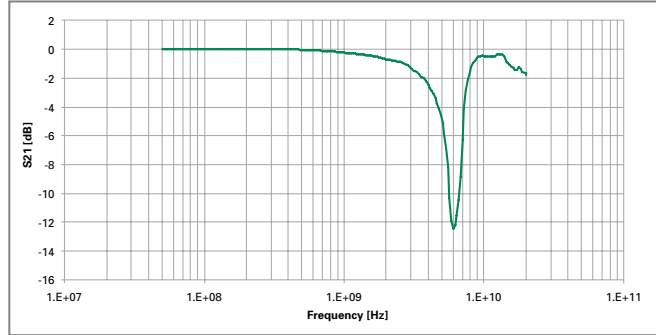

**Device Dimensions**

**'C' Type Core Devices**

Dimensions are in millimeters [and inches]

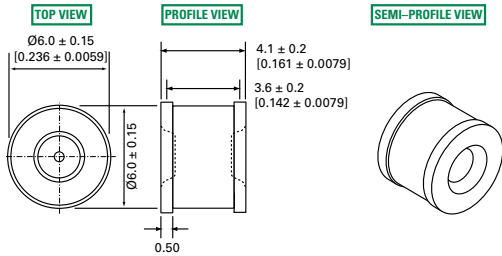

**'SM' Type Surface Mount Devices**

Dimensions are in millimeters [and inches]

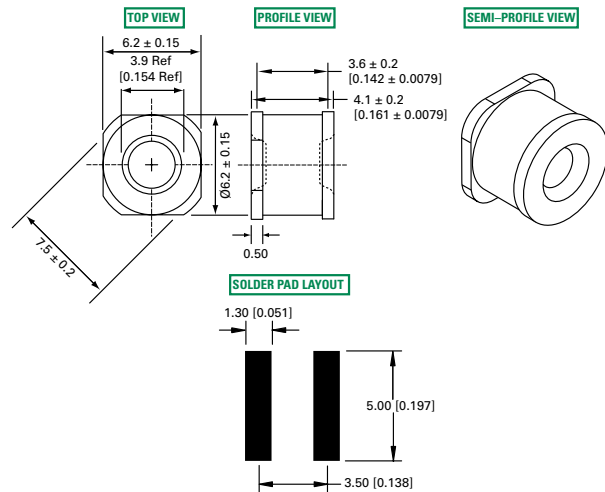

### Soldering Parameters - Reflow Soldering (Surface Mount Devices)

|  |                                    |                         |
|--|------------------------------------|-------------------------|
| Reflow Condition                                       |                                    | Pb-free assembly        |
| Pre Heat   | - Temperature Min ( $T_{s(min)}$ ) | 150°C                   |
|  | - Temperature Max ( $T_{s(max)}$ ) | 200°C                   |
|  | - Time (Min to Max) ( $t_s$ )      | 60 – 180 seconds        |
| Average Ramp-up Rate (Liquidus Temp ( $T_L$ ) to peak) |                                    | 3°C/second max.         |
| $T_{s(max)}$ to $T_L$ - Ramp-up Rate                   |                                    | 5°C/second max.         |
| Reflow   | - Temperature ( $T_L$ ) (Liquidus) | 217°C                   |
|  | - Temperature ( $t_L$ )            | 60 – 150 seconds        |
| Peak Temperature ( $T_p$ )                             |                                    | 260 <sup>+0/-5</sup> °C |
| Time within 5°C of Actual Peak Temperature ( $t_p$ )   |                                    | 10 – 30 seconds         |
| Ramp-down Rate   |                                    | 6°C/second max.         |
| Time 25°C to Peak Temperature ( $T_p$ )                |                                    | 8 minutes max.          |
| Do not exceed  |                                    | 260°C                   |

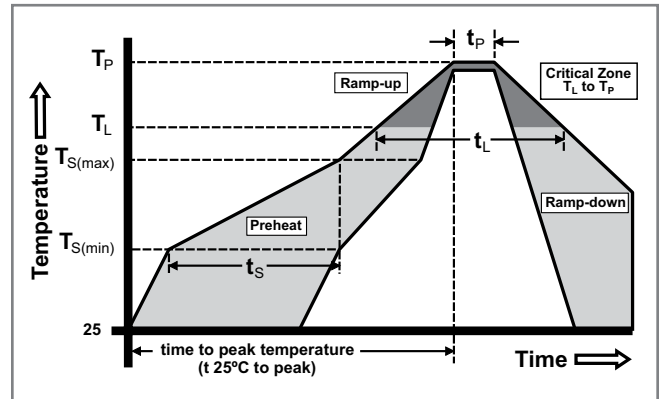

### Soldering Parameters - Wave Soldering (Thru-Hole Devices)

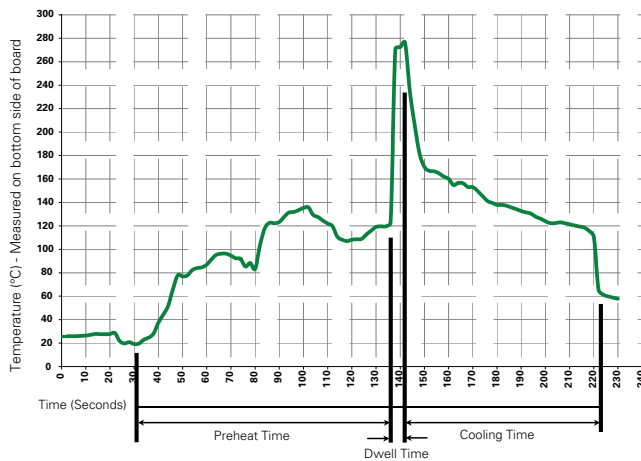

### Recommended Process Parameters:

| Wave Parameter                           | Lead-Free Recommendation          |
|--|-----------------------------------|
| <b>Preheat:</b>                          |                                   |
| (Depends on Flux Activation Temperature) | (Typical Industry Recommendation) |
| Temperature Minimum:                     | 100° C                            |
| Temperature Maximum:                     | 150° C                            |
| Preheat Time:                            | 60-180 seconds                    |
| <b>Solder Pot Temperature:</b>           | 280° C Maximum                    |
| <b>Solder Dwell Time:</b>                | 2-5 seconds                       |

### Soldering Parameters - Hand Soldering

Solder Iron Temperature: 350° C +/- 5°C  
 Heating Time: 5 seconds max.

**Packaging**

**'C' Type Core Items:** Package bulk pack in polybag, 1000 pcs/bag

**'SM' Type Surface Mount Items:** Packaged tape and reel carrier, 1000 pcs/reel (specifications below)

Dimensions are in millimeters [and inches]

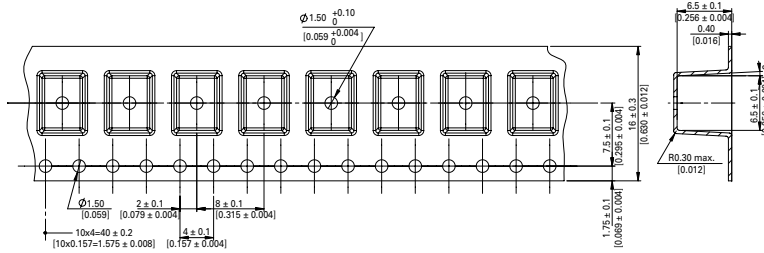

Dimensions are in millimeters [and inches]

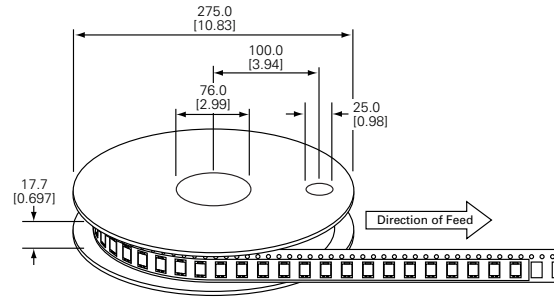

**Part Numbering System and Ordering Information**

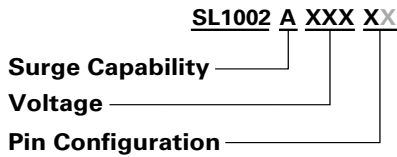

- C** = Core (Packed in polybag, 1000pcs/bag)
- SM** = Surface Mount (Packed in carrier and tape, 1000pcs/reel)

**Disclaimer Notice** - Information furnished is believed to be accurate and reliable. However, users should independently evaluate the suitability of and test each product selected for their own applications. Littelfuse products are not designed for, and may not be used in, all applications. Read complete Disclaimer Notice at: [www.littelfuse.com/disclaimer-electronics](http://www.littelfuse.com/disclaimer-electronics).