

Automotive PLED Series (PLEDxS-A)

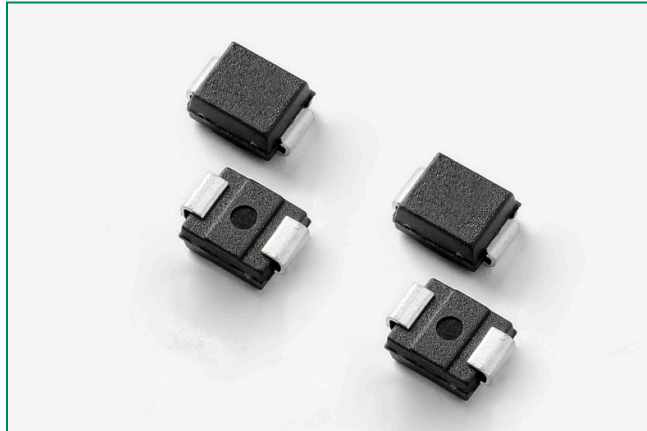

Description

Automotive PLED Series (PLEDxS-A) open LED protectors provide a switching electronic shunt path when an LED in an LED string fails as an open circuit. This ensures that the remaining string of LEDs will continue to function if a single LED does not.

This series is designed for automotive applications such as automotive car head lamp, tail lamp, LED indicator protection, aircraft runway lighting and other applications need high reliability requirements.

Compatible with one, two and three watt LEDs that have a nominal 3V forward characteristic.

Agency Approvals

Agency	Agency File Number
	E133083

Schematic Symbol

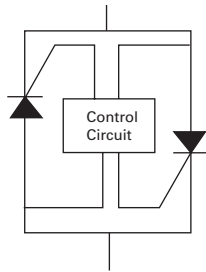

Features

- Recognized to UL 497B as an Isolated Loop Circuit Protector
- AEC-Q101 Qualified and PPAP Capable
- Fast switching
- Automatically resets after power cycle
- Available in standard DO-214AA package
- Compatible with industrial lighting environments
- IEC-61000-4-2 ESD 30kV (Air), 30kV (Contact)
- ESD protection of data lines in accordance with IEC 61000-4-2 (IEC801-2)
- Compatible with PWM frequencies up to 30 kHz
- RoHS compliant and halogen-free

Electrical Characteristics (All parameters are measured at $T_A=25^\circ\text{C}$ unless otherwise noted)

Part Number	Marking	V_{DRM}	V_s	I_H	I_s	$I_T @ V_T$	$V_T @ I_T = 1$	Critical rate of rise dV/dt
		@ $I_{\text{DRM}} = 5\mu\text{A}$	@ $100\text{V}/\mu\text{s}$	mAmps	mAmps	Amps	Volts	
		Volts	Volts	Min	Max	Max	Max	
PLED6S-A	AL6	6	27	5	100	1.0	1.2	250V/ μs
PLED9S-A	AL9	9	30	5	100	1.0	1.2	250V/ μs
PLED13S-A	AL13	13	44	5	100	1.0	1.2	250V/ μs
PLED18S-A	AL18	18	55	5	100	1.0	1.2	250V/ μs

Thermal Considerations

Symbol	Parameter	Value	Unit
T_J	Operating Junction Temperature Range	-55 to +150	°C
T_S	Storage Temperature Range	-65 to +150	°C
$R_{\theta JA}$	Thermal Resistance: Junction to Ambient	DO-214AA: 125 ¹ DO-214AA: 40 ²	°C/W

Notes:

1) Standard FR-4 PCB with Copper Pads (Recommended Size)

2) Aluminium PCB

Thickness: 1.6mm

Grade: 1-2 W/mK Thermal Conductivity

Trace thickness: 2 oz

Insulation layer thickness: 215 μ m

Solder Pad Dimensions: 2.0mm x 2.8mm (Recommended Size)

V-I Characteristics

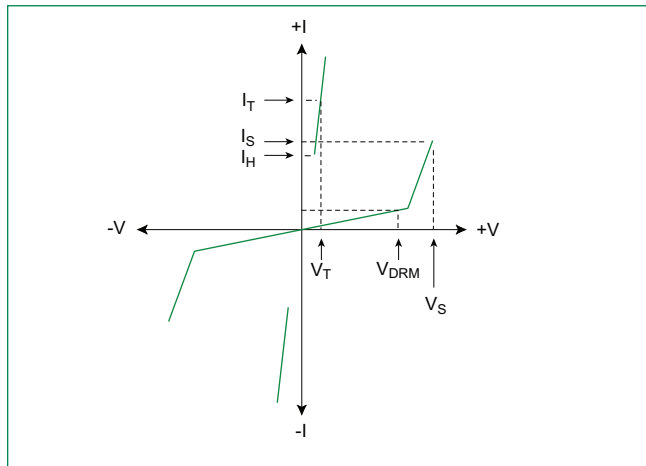

Normalized DC Holding Current vs. Case Temperature

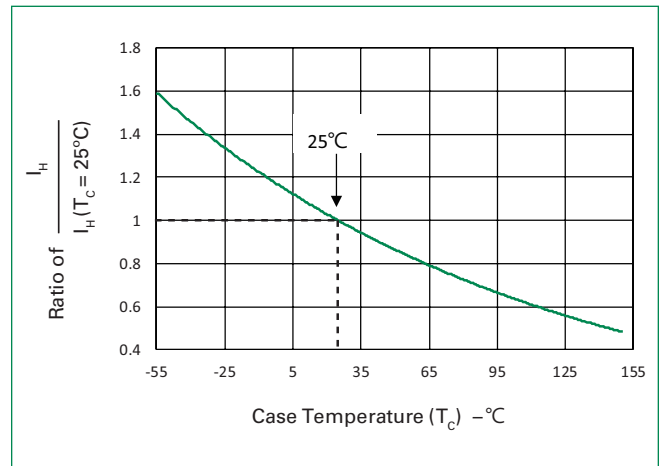

Normalized V_S Change vs. Junction Temperature

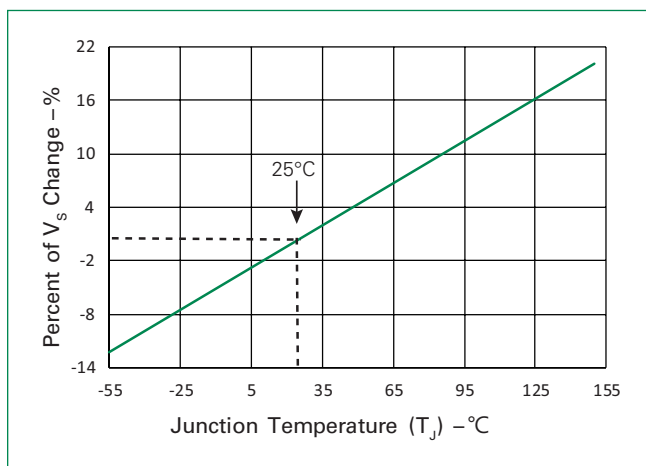

LED Interference Test Circuit

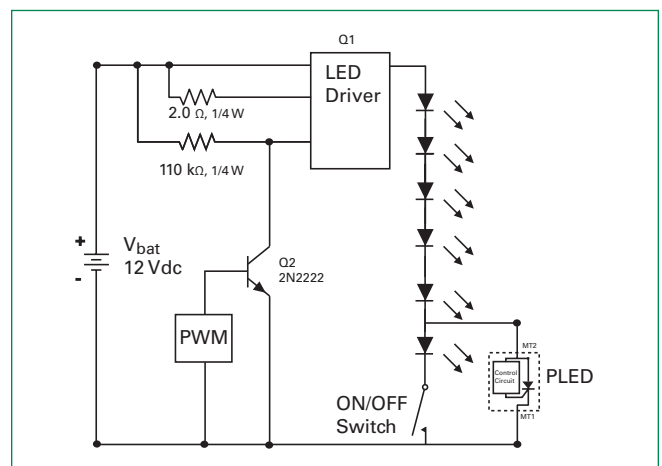

6 LEDs in Series 50% Duty Cycle 10kHz

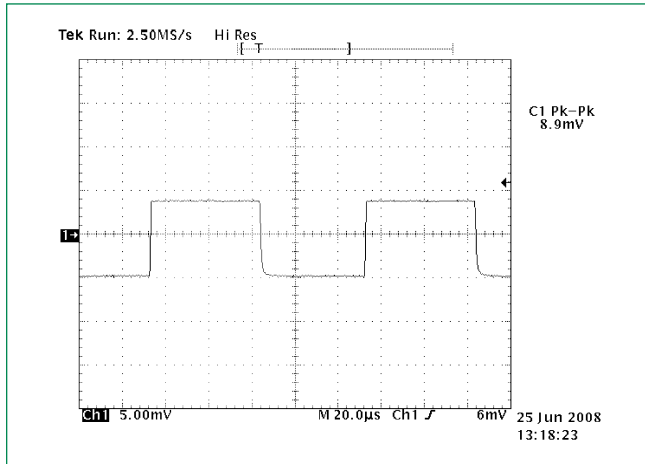

5 LEDs and 1 PLED in Series 50% Duty Cycle 10kHz

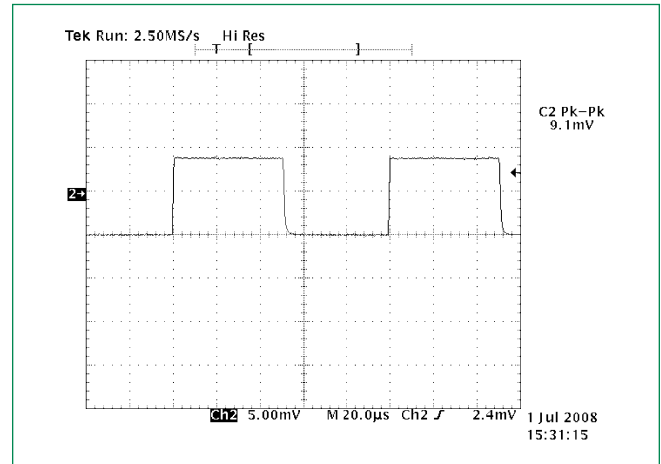

Note: These two graphs show the current magnitude through the LED string with and without the PLED included. There is no noticeable effect on the LED current magnitude when the PLED is included in the circuit as compared to the LED current magnitude when the PLED is not in the circuit. (The conversion factor for the test measurement in the graphs above is 10mA/mV for the Pearson coil measurement, therefore, the current magnitude in the first figure is 10mA*8.9 = 89mA, while the second figure is 91mA.)

PLED in the Off-State 10kHz

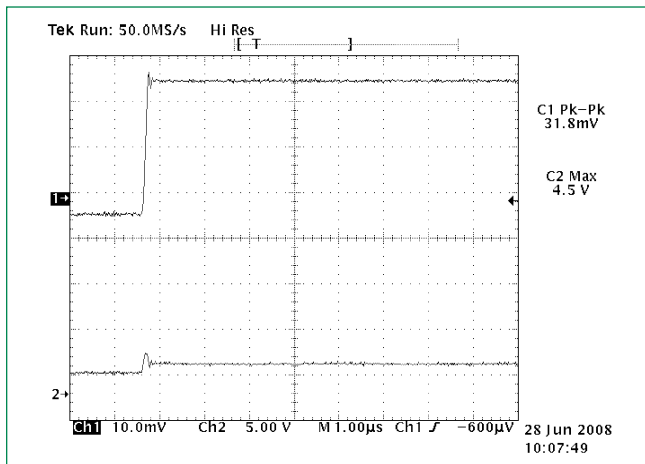

Channel 1: current through LEDs (318 mA)
 Channel 2: voltage across PLED component (4.5 V)

PLED component zeners and then turns fully on 10kHz

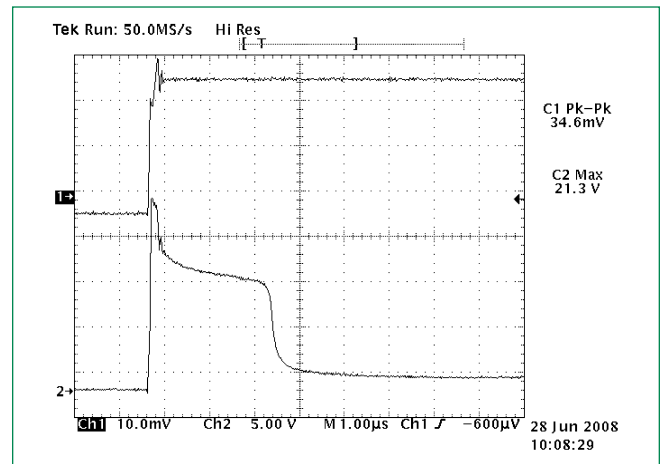

Channel 1: current through LEDs (346 mA) and PLED component once it is fully turned on 2.5 µsec later
 Channel 2: voltage across PLED component (21.3 V before PLED crowbars with 2 V drop)

Soldering Parameters

Reflow Condition		Pb – Free assembly
Pre Heat	- Temperature Min ($T_{s(min)}$)	150°C
	- Temperature Max ($T_{s(max)}$)	200°C
	- Time (min to max) (t_s)	60 – 180 secs
Average ramp up rate (LiquidusTemp (T_L) to peak)		3°C/second max
$T_{s(max)}$ to T_L - Ramp-up Rate		3°C/second max
Reflow	- Temperature (T_L) (Liquidus)	217°C
	- Temperature (t_L)	60 – 150 seconds
Peak Temperature (T_p)		260 ^{+0/-5} °C
Time within 5°C of actual peak Temperature (t_p)		30 seconds
Ramp-down Rate		6°C/second max
Time 25°C to peak Temperature (T_p)		8 minutes max
Do not exceed		260°C

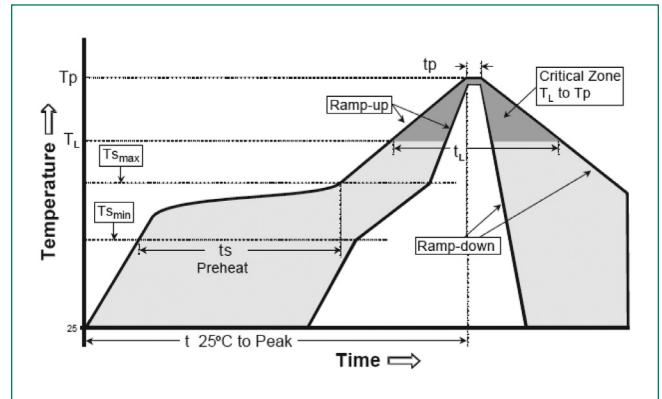

Physical Specifications

Terminal Material	Copper Alloy
Terminal Finish	100% Matte Tin Plated
Body Material	UL recognized compound meeting flammability classification V-0

Environmental Specifications

High Temp Voltage Blocking	80% Rated V_{DRM} (V_{DC} Peak) +150°C, 1008 hrs. MIL-STD-750 (Method 1040) JEDEC, JESD22-A-101
Temp Cycling	-55°C to +150°C, 15 min. dwell, 1000 cycles. MIL-STD-750 (Method 1051) EIA/JEDEC, JESD22-A104
Biased Temp & Humidity	80% Rated V_{DRM} (+85°C) 85%RH, 504 up to 1008 hrs. EIA/JEDEC, JESD22-A-101
Unbiased Highly Accelerated Stress Test	+130°C, 85%RH, 2atm, 96hrs. JESD22A-118
Resistance to Solder Heat	+260°C, 10 secs. MIL-STD-750 (Method 2031)
Moisture Sensitivity Level	85%RH, +85°C, 168 hrs., 3 reflow cycles (+260°C Peak). JEDEC-J-STD-020, Level 1

Part Numbering System

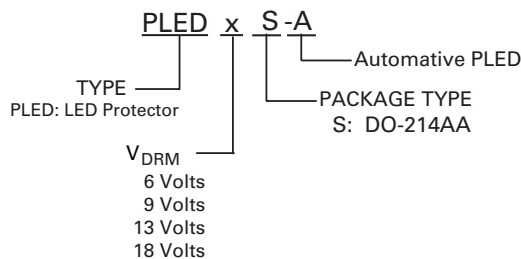

Part Marking System

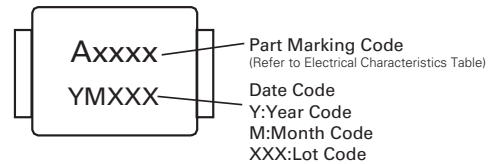

Packaging

Package	Description	Packaging Quantity	Industry Standard
S	DO-214AA	2500	EIA-481-1

Dimensions - DO-214 AA Package

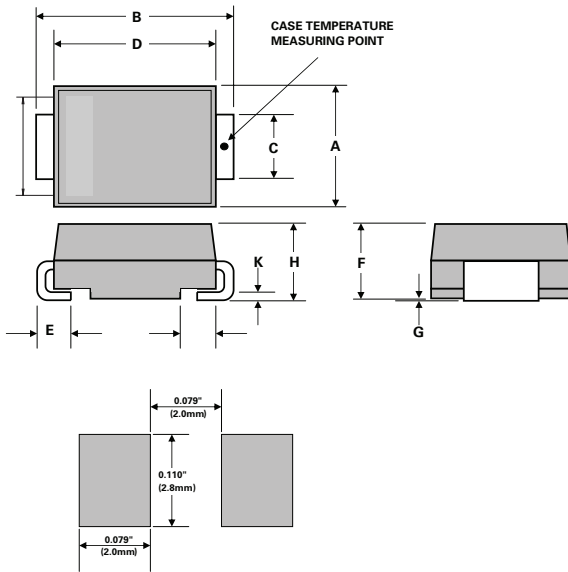

Dimensions	Inches		Millimeters	
	Min	Max	Min	Max
A	0.130	0.156	3.30	3.95
B	0.201	0.220	5.10	5.60
C	0.077	0.087	1.95	2.20
D	0.159	0.181	4.05	4.60
E	0.030	0.063	0.75	1.60
F	0.075	0.096	1.90	2.45
G	0.002	0.008	0.05	0.20
H	0.077	0.104	1.95	2.65
K	0.006	0.016	0.15	0.41

Recommended solder pad layout
(Reference Only)

DO-214AA Embossed Carrier Reel Pack (RP)

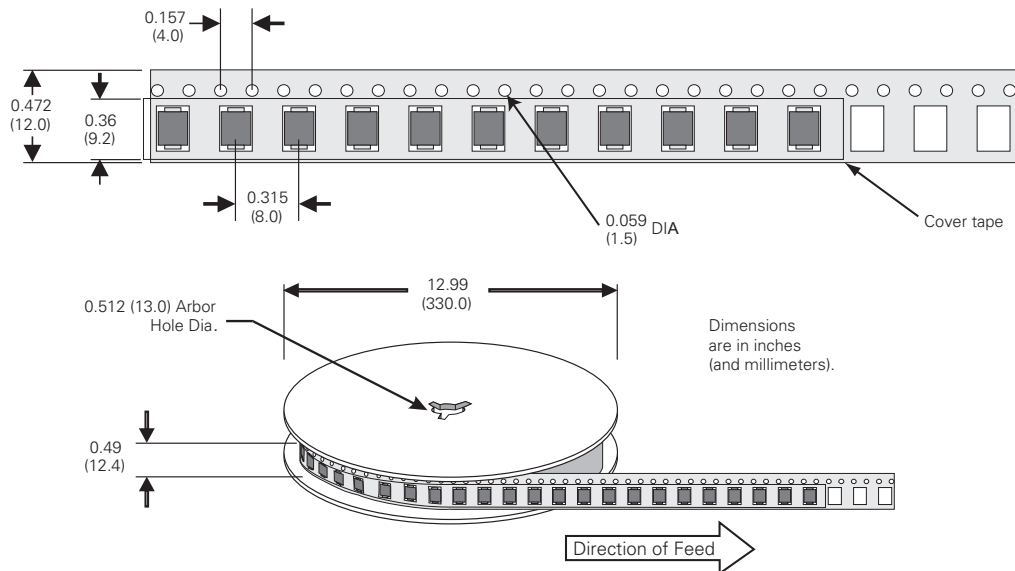

Dimensions are in inches (and millimeters).

Disclaimer Notice - Information furnished is believed to be accurate and reliable. However, users should independently evaluate the suitability of and test each product selected for their own applications. Littelfuse products are not designed for, and may not be used in, all applications. Read complete Disclaimer Notice at <http://www.littelfuse.com/disclaimer-electronics>.