

**PLEDxN Series**



**Description**

The open LED protector provides a switching electronic shunt path when a single LED in an LED string fails as an open circuit. This ensures the entire LED string will continue to function even if a single LED in the string does not. This provides higher reliable lighting functions in applications such as headlights, aircraft lights, airport runway lighting, roadside warning lights, etc. This component is compatible with one watt rated LEDs with a nominal 350 mA current at 3V. The SOD-123FL package is one of the lowest height profiles (1.1 mm) packages offered in the industry.

**Pinout Diagram**

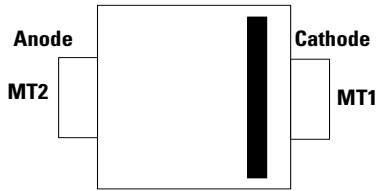

**Features & Benefits**

- Fast switching
- Automatically resets after power cycle
- Compatible with industrial standard package SOD-123FL
- Compatible with industrial lighting environments
- IEC 61000-4-2 ESD 30kV (Air), 30kV (Contact)
- ESD protection of data lines in accordance with IEC 61000-4-2
- Low profile: maximum height of 1.1mm
- RoHS compliant and halogen-free
- MSL: Level 1 - unlimited

**Schematic Symbol**

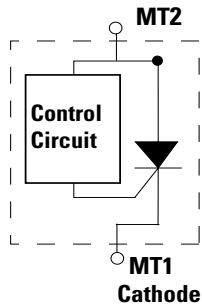

**Electrical Characteristics (All parameters are measured at  $T_A = 25^\circ\text{C}$  unless otherwise noted)**

Part Number	Marking	$V_{BR}$ @ $I_{BR} = 1 \text{ mAmps}$		$I_{LEAK}$ $V_{MT2} = 5V$	$I_H$	$I_S$	$I_T @ V_T$	$V_T$ @ $I_T = 350\text{mA}$	Critical rate of rise $dV/dt$	Capacitance @ 1MHz, 2V bias
		Volts		$\mu\text{A}$	$\text{mA}$	$\text{mA}$	$\text{A}$	$\text{V}$		
		Min	Max	Max	Max	Max	Max	Max		
PLED6N	P6N	5.5	7.5	250	12	70	1.0 <sup>1,2</sup>	1.2	250	24

**Notes:**

- 1) Standard FR-4 PCB with Copper Pads (2mm x 2mm/pad)
- 2) Aluminum PCB Pads (2mm x 3mm/pad)

### Thermal Considerations

Symbol	Parameter	Value	Unit
$I_T$	Average On-State Current, ( $T_A = 25^\circ\text{C}$ )	1.0 <sup>1,2</sup>	A
$V_T$	On-state Voltage ( $T_A = 125^\circ\text{C}$ )	1.0	V
$P_D$	Power Dissipation ( $T_A = 25^\circ\text{C}$ )	1.45 <sup>1</sup>	W
		1.50 <sup>2</sup>	
$T_J$	Operating Junction Temperature Range	-65 to +150	$^\circ\text{C}$
$T_S$	Storage Temperature Range		$^\circ\text{C}$
$R_{\theta JL}$	Thermal Resistance: Junction to Lead	25 <sup>1</sup>	$^\circ\text{C/W}$
		20 <sup>2</sup>	
$R_{\theta JA}$	Thermal Resistance: Junction to Ambient	80 <sup>1</sup>	$^\circ\text{C/W}$
		50 <sup>2</sup>	

**Notes:**

- 1) Standard FR-4 PCB with Copper Pads (2mm x 2mm/pad)
- 2) Aluminum PCB Pads (2mm x 3mm/pad)

### V-I Characteristics

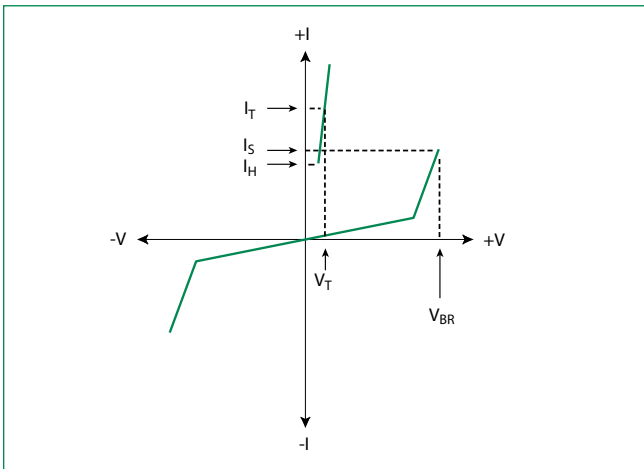

### $V_{BR}$ vs. Junction Temperature

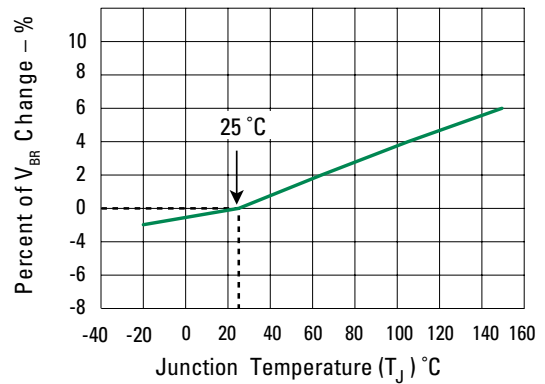

### Normalized DC Holding Current vs. Ambient Temperature

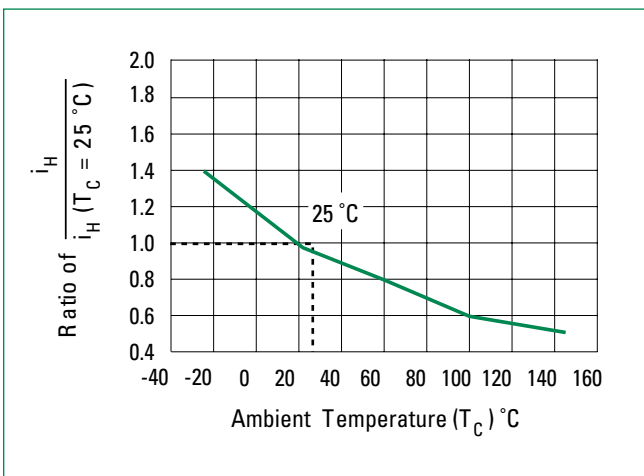

### Capacitance vs Voltage

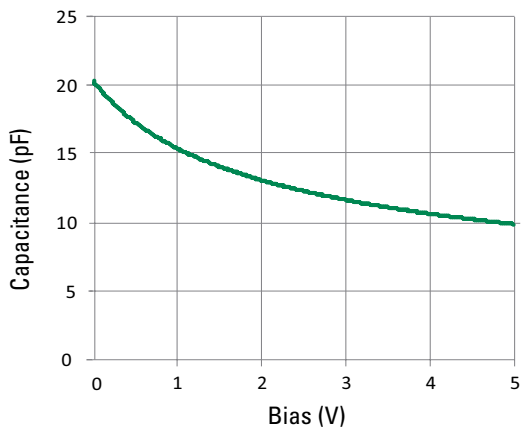

**Leakage Current vs Temperature**

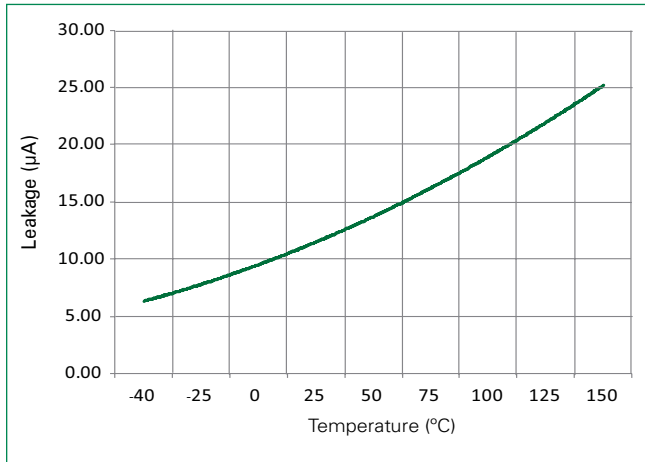

**$V_T$  vs  $I_T$**

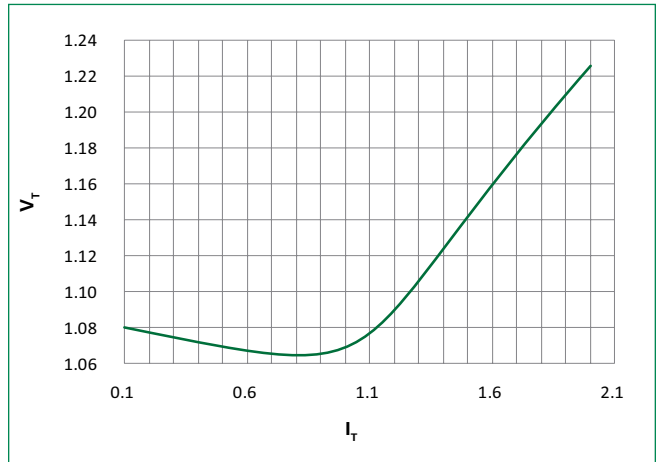

**Operating Current vs. Ambient Temperature**

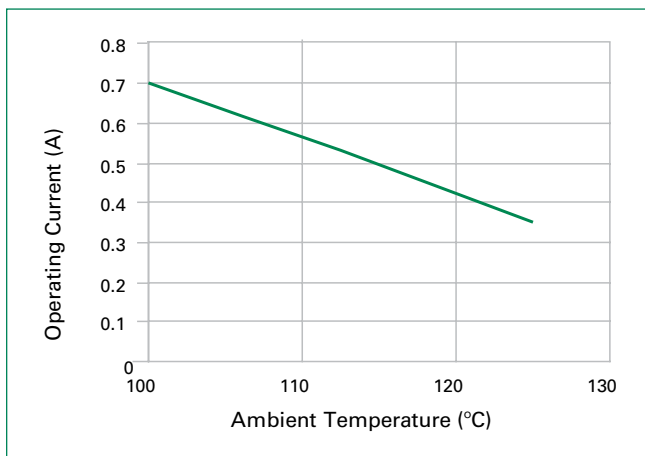

**LED Interference Test Circuit**

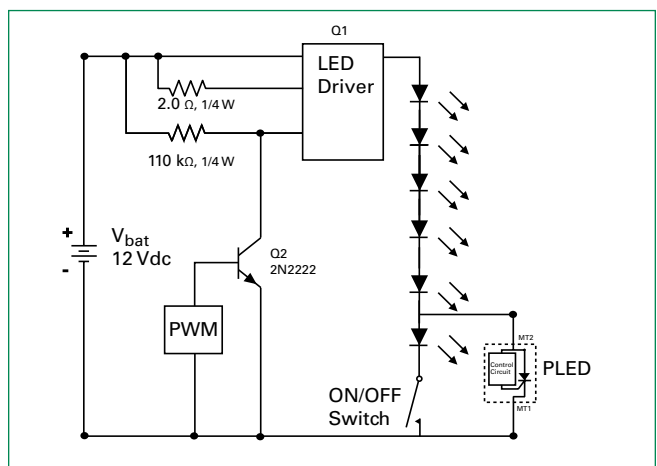

**Typical Operation Waveforms**

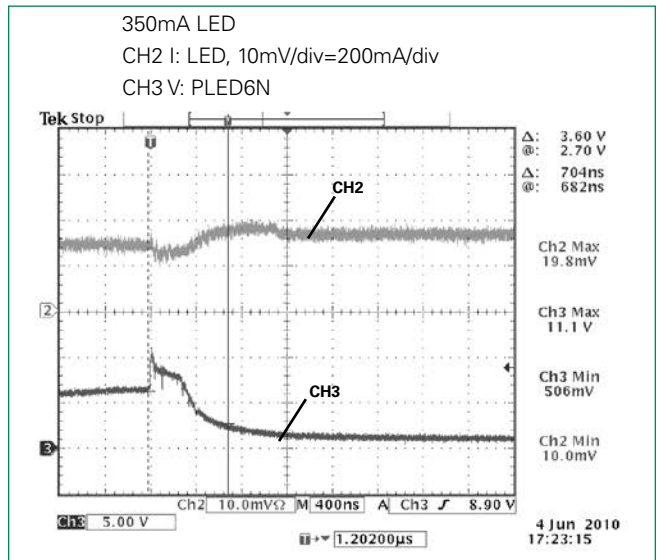
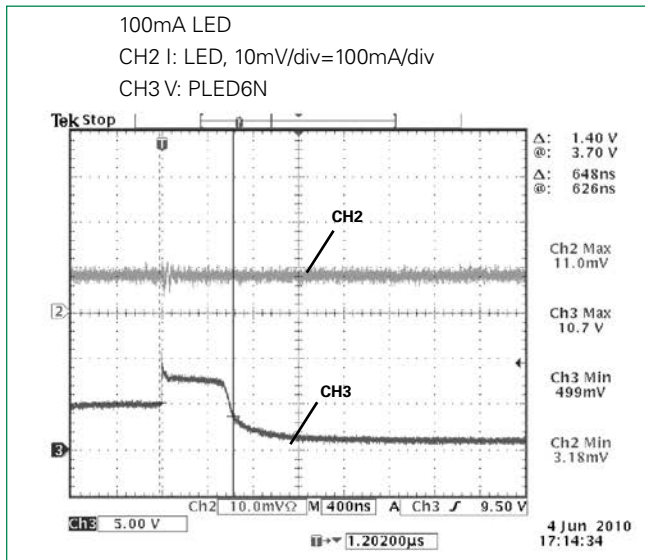

### Soldering Parameters

<b>Reflow Condition</b>		Pb – Free assembly
<b>Pre Heat</b>	- Temperature Min ( $T_{s(min)}$ )	150°C
	- Temperature Max ( $T_{s(max)}$ )	200°C
	- Time (min to max) ( $t_s$ )	60 – 180 secs
<b>Average ramp up rate (Liquidus Temp (<math>T_L</math>) to peak)</b>		3°C/second max
<b><math>T_{s(max)}</math> to <math>T_L</math> - Ramp-up Rate</b>		3°C/second max
<b>Reflow</b>	- Temperature ( $T_L$ ) (Liquidus)	217°C
	- Temperature ( $t_L$ )	60 – 150 seconds
<b>Peak Temperature (<math>T_p</math>)</b>		260 <sup>+0/-5</sup> °C
<b>Time within 5°C of actual peak Temperature (<math>t_p</math>)</b>		30 seconds
<b>Ramp-down Rate</b>		6°C/second max
<b>Time 25°C to peak Temperature (<math>T_p</math>)</b>		8 minutes max
<b>Do not exceed</b>		260°C

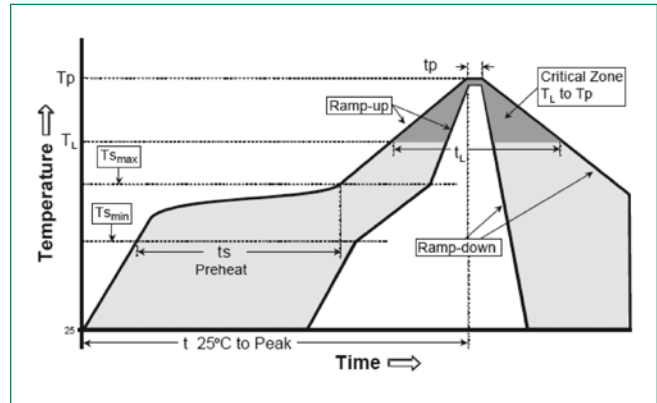

### Physical Specifications

<b>Terminal Material</b>	Copper Alloy
<b>Terminal Finish</b>	100% Matte Tin Plated
<b>Body Material</b>	UL recognized epoxy meeting flammability classification V-0

### Packaging

Package Code	Description	Packaging Quantity	Industry Standard
N	SOD-123FL	3000	EIA-481 Tape and Reel

### Part Numbering System

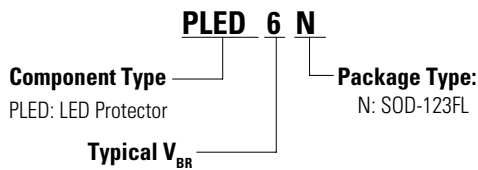

### Environmental Specifications

<b>High Temperature Voltage Blocking</b>	MIL-STD-750: Method 1040, Condition A, 80% min $V_{BR}$ DC, 150°C, 504 hours
<b>Temperature Cycling</b>	MIL-STD-750: Method 1051, -65°C to 150°C, 15-minute dwell, 100 cycles
<b>Biased Temperature &amp; Humidity</b>	EIA/JEDEC: JESD22-A101, 80% min $V_{BR}$ , 85°C, 85%RH, 1008 hours
<b>Resistance to Solder Heat</b>	MIL-STD-750: Method 2031, 260°C, 10 seconds
<b>Moisture Sensitivity Level</b>	JEDEC-J-STD-020, Level 1
<b>Burn-In Test</b>	$I_T = 0.350$ Adc, 1008 hours

### Part Marking System

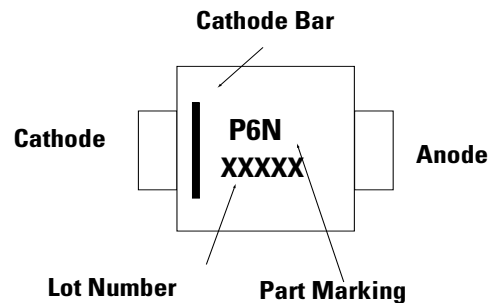

**Dimensions - SOD-123FL Package**

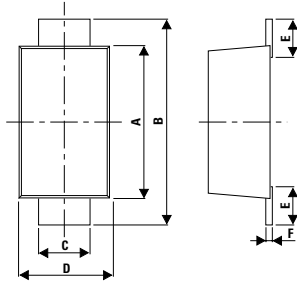

Dimensions	Millimeters		Inches	
	Min	Max	Min	Max
A	2.50	2.90	0.0984	0.1142
B	3.40	3.90	0.1339	0.1535
C	0.70	1.20	0.0275	0.0472
D	1.50	2.00	0.0591	0.0787
E	0.35	0.90	0.0138	0.0354
F	0.05	0.26	0.0020	0.0102
G	0.00	0.10	0.0000	0.0039
H	0.95	1.10	0.0374	0.0433

**Mounting Pad Layout**

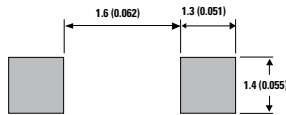

**Tape and Reel Specification**

