

MG12450WB-BN2MM

RoHS

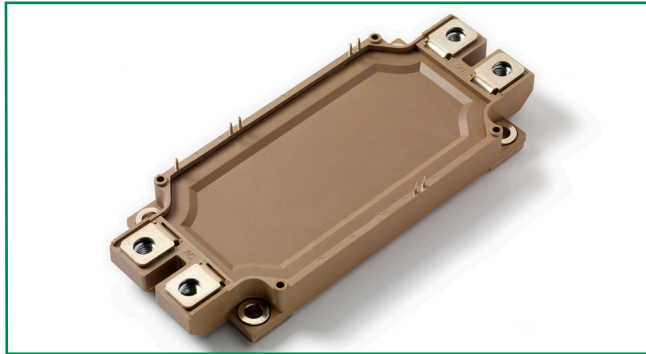

Features

- IGBT³ CHIP(Trench+Field Stop technology)
- Low saturation voltage and positive temperature coefficient
- Fast switching and short tail current
- Free wheeling diodes with fast and soft reverse recovery
- Temperature sense included

Applications

- AC motor control
- Motion/servo control
- Photovoltaic/Fuel cell
- Inverter and power supplies

Module Characteristics ($T_J = 25^\circ\text{C}$, unless otherwise specified)

| Symbol | Parameters | Test Conditions | Min | Typ | Max | Unit |
|-------------------|----------------------------|------------------|-----|------|-----|------------------|
| $T_{J\max}$ | Max. Junction Temperature | | | | 150 | $^\circ\text{C}$ |
| $T_{J\text{op}}$ | Operating Temperature | | -40 | | 125 | $^\circ\text{C}$ |
| T_{stg} | Storage Temperature | | -40 | | 125 | $^\circ\text{C}$ |
| V_{isol} | Insulation Test Voltage | AC, t=1min | | 3000 | | V |
| CTI | Comparative Tracking Index | | 210 | | | |
| Torque | Module-to-Sink | Recommended (M5) | 2.5 | | 5 | N·m |
| Torque | Module Electrodes | Recommended (M6) | 3 | | 5 | N·m |
| Weight | | | | 350 | | g |

Absolute Maximum Ratings ($T_J = 25^\circ\text{C}$, unless otherwise specified)

| Symbol | Parameters | Test Conditions | Values | Unit |
|--------------------|-----------------------------------|---|----------|----------------------|
| IGBT | | | | |
| V_{CES} | Collector - Emitter Voltage | $T_J = 25^\circ\text{C}$ | 1200 | V |
| V_{GES} | Gate - Emitter Voltage | | ± 20 | V |
| I_C | DC Collector Current | $T_C = 25^\circ\text{C}$ | 600 | A |
| | | $T_C = 80^\circ\text{C}$ | 450 | A |
| I_{CM} | Repetitive Peak Collector Current | $t_p = 1\text{ms}$ | 900 | A |
| P_{tot} | Power Dissipation Per IGBT | | 1950 | W |
| Diode | | | | |
| V_{RRM} | Repetitive Reverse Voltage | $T_J = 25^\circ\text{C}$ | 1200 | V |
| $I_{\text{F(AV)}}$ | Average Forward Current | $T_C = 25^\circ\text{C}$ | 450 | A |
| | | $T_C = 80^\circ\text{C}$ | 350 | A |
| I_{FRM} | Repetitive Peak Forward Current | $t_p = 1\text{ms}$ | 900 | A |
| I^2t | | $T_J = 125^\circ\text{C}$, $t = 10\text{ms}$, $V_R = 0\text{V}$ | 34000 | A^2s |

Electrical and Thermal Specifications ($T_J = 25^\circ\text{C}$, unless otherwise specified)

| Symbol | Parameters | Test Conditions | Min | Typ | Max | Unit |
|---------------|---|---|-------------------------|------|-------|---------------|
| IGBT | | | | | | |
| $V_{GE(th)}$ | Gate - Emitter Threshold Voltage | $V_{CE}=V_{GE}, I_C=18\text{mA}$ | 5.0 | 5.8 | 6.5 | V |
| $V_{CE(sat)}$ | Collector - Emitter | $I_C=450\text{A}, V_{GE}=15\text{V}, T_J=25^\circ\text{C}$ | | 1.7 | | V |
| | Saturation Voltage | $I_C=450\text{A}, V_{GE}=15\text{V}, T_J=125^\circ\text{C}$ | | 2.0 | | V |
| I_{ICES} | Collector Leakage Current | $V_{CE}=1200\text{V}, V_{GE}=0\text{V}, T_J=25^\circ\text{C}$ | | | 1 | mA |
| | | $V_{CE}=1200\text{V}, V_{GE}=0\text{V}, T_J=125^\circ\text{C}$ | | | 5 | mA |
| I_{GES} | Gate Leakage Current | $V_{CE}=0\text{V}, V_{GE}=\pm 15\text{V}, T_J=125^\circ\text{C}$ | -400 | | 400 | nA |
| R_{Gint} | Integrated Gate Resistor | | | 1.7 | | Ω |
| Q_{ge} | Gate Charge | $V_{CE}=600\text{V}, I_C=450\text{A}, V_{GE}=\pm 15\text{V}$ | | 4.3 | | μC |
| C_{ies} | Input Capacitance | $V_{CE}=25\text{V}, V_{GE}=0\text{V}, f=1\text{MHz}$ | | 32 | | nF |
| C_{res} | Reverse Transfer Capacitance | | | | 1.5 | |
| $t_{d(on)}$ | Turn - on Delay Time | $V_{CC}=600\text{V}$ $I_C=450\text{A}$ $R_G=1.6\Omega$ $V_{GE}=\pm 15\text{V}$ Inductive Load | $T_J=25^\circ\text{C}$ | | 160 | ns |
| | | | $T_J=125^\circ\text{C}$ | | 170 | ns |
| t_r | Rise Time | | $T_J=25^\circ\text{C}$ | | 45 | ns |
| | | | $T_J=125^\circ\text{C}$ | | 50 | ns |
| $t_{d(off)}$ | Turn - off Delay Time | | $T_J=25^\circ\text{C}$ | | 460 | ns |
| | | | $T_J=125^\circ\text{C}$ | | 530 | ns |
| t_f | Fall Time | | $T_J=25^\circ\text{C}$ | | 100 | ns |
| | | | $T_J=125^\circ\text{C}$ | | 150 | ns |
| E_{on} | Turn - on Energy | | $T_J=25^\circ\text{C}$ | | 20 | mJ |
| | | | $T_J=125^\circ\text{C}$ | | 31 | mJ |
| E_{off} | Turn - off Energy | $T_J=25^\circ\text{C}$ | | 33 | mJ | |
| | | $T_J=125^\circ\text{C}$ | | 55 | mJ | |
| I_{SC} | Short Circuit Current | $t_{psc} \leq 10\mu\text{s}, V_{GE}=15\text{V}, T_J=125^\circ\text{C}, V_{CC}=900\text{V}$ | | 1800 | | A |
| R_{thJC} | Junction-to-Case Thermal Resistance (Per IGBT) | | | | 0.064 | K/W |
| Diode | | | | | | |
| V_F | Forward Voltage | $I_F=450\text{A}, V_{GE}=0\text{V}, T_J=25^\circ\text{C}$ | | 1.65 | | V |
| | | $I_F=450\text{A}, V_{GE}=0\text{V}, T_J=125^\circ\text{C}$ | | 1.6 | | V |
| t_{RR} | Reverse Recovery Time | $I_F=450\text{A}, V_R=600\text{V}$ $di_F/dt=-7200\text{A}/\mu\text{s}$ $T_J=125^\circ\text{C}$ | | 255 | | ns |
| I_{RRM} | Max. Reverse Recovery Current | | | 385 | | A |
| E_{rec} | Reverse Recovery Energy | | | 38 | | mJ |
| R_{thJCD} | Junction-to-Case Thermal Resistance (Per Diode) | | | | 0.12 | K/W |

NTC Characteristics ($T_J = 25^\circ\text{C}$, unless otherwise specified)

| Symbol | Parameters | Test Conditions | Min | Typ | Max | Unit |
|-------------|------------|------------------------|-----|------|-----|------------|
| R_{25} | Resistance | $T_c=25^\circ\text{C}$ | | 5 | | K Ω |
| $B_{25/50}$ | | | | 3375 | | K |

Figure 1: Typical Output Characteristics for IGBT Inverter

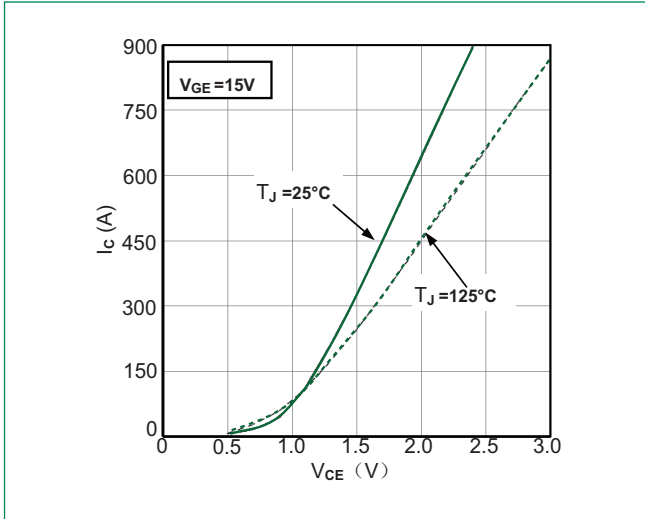

Figure 2: Typical Output Characteristics for IGBT Inverter

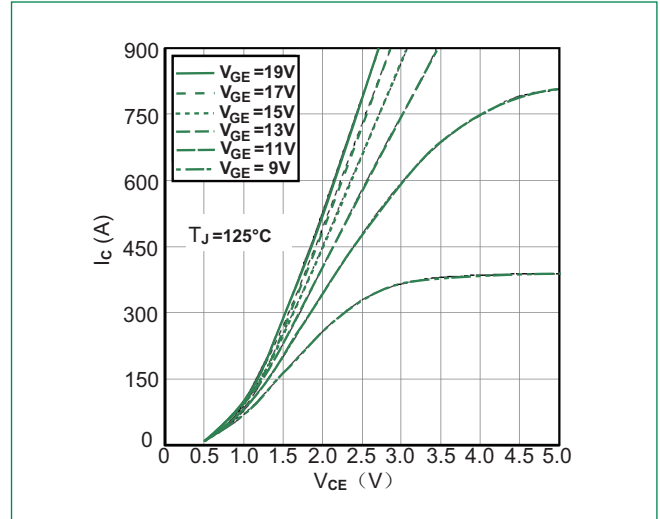

Figure 3: Typical Transfer Characteristics for IGBT Inverter

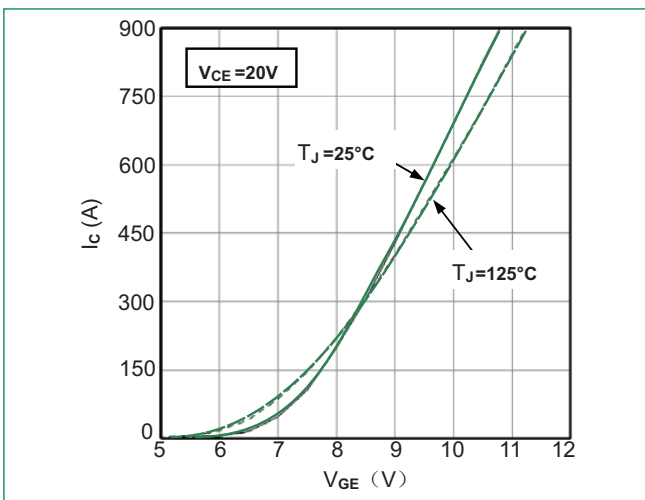

Figure 4: Switching Energy vs. Gate Resistor for IGBT Inverter

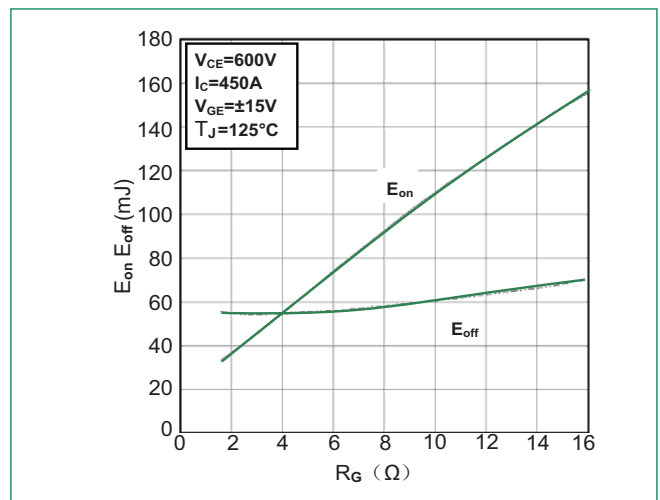

Figure 5: Switching Energy vs. Collector Current for IGBT Inverter

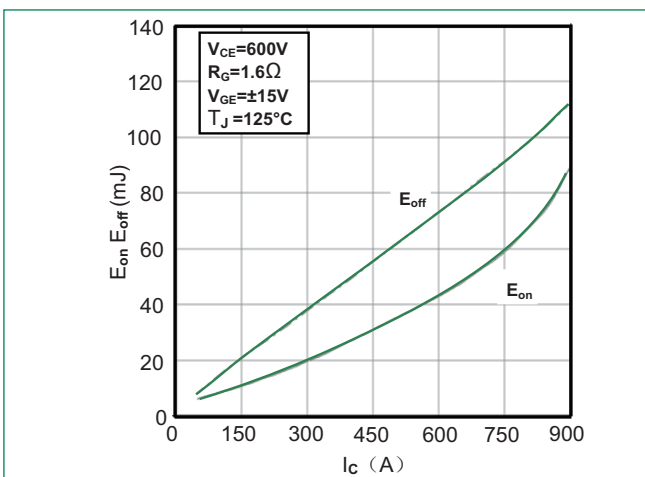

Figure 6: Reverse Biased Safe Operating Area for IGBT Inverter

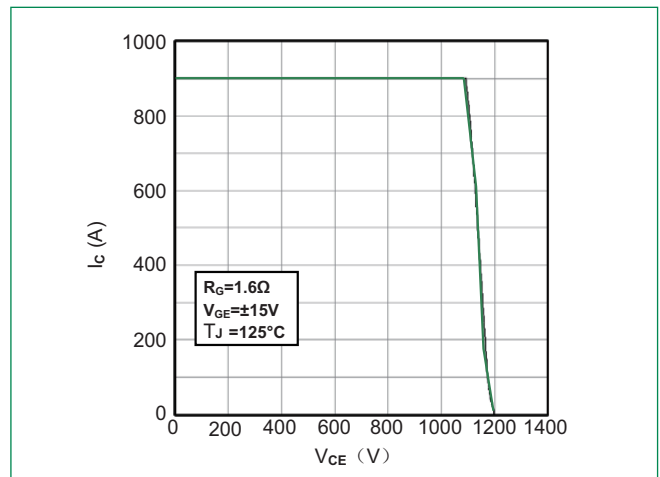

Figure 7: Diode Forward Characteristics for Diode Inverter

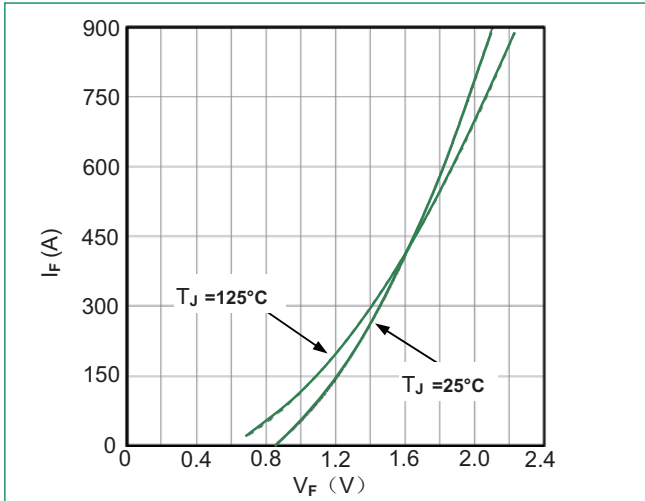

Figure 8: Switching Energy vs. Gate Resistort for Diode Inverter

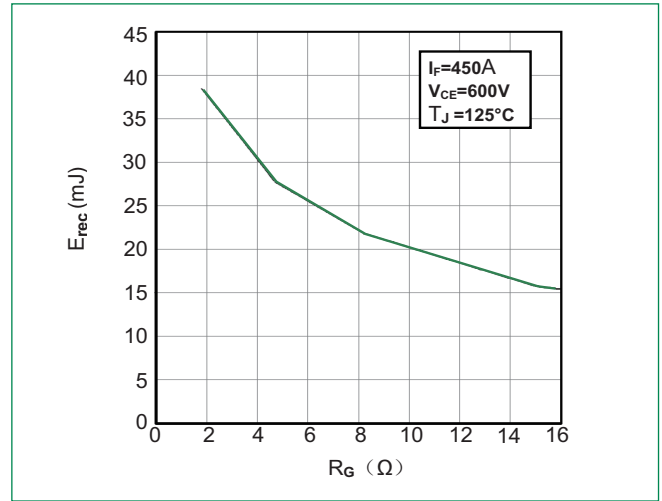

Figure 9: Transient Thermal Impedance of Diode and IGBT Inverter

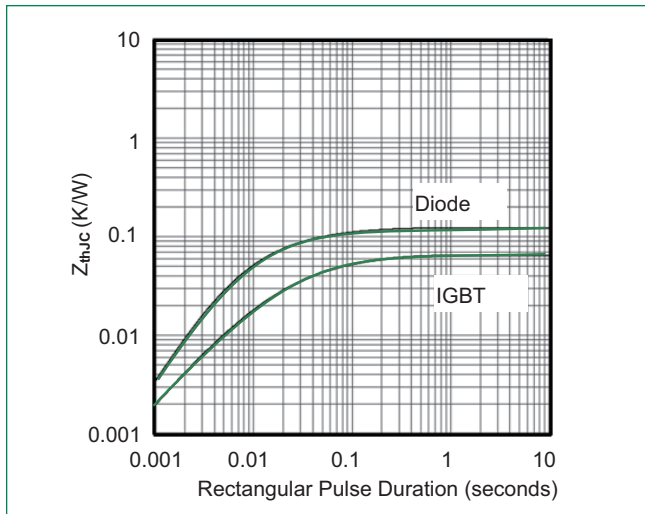
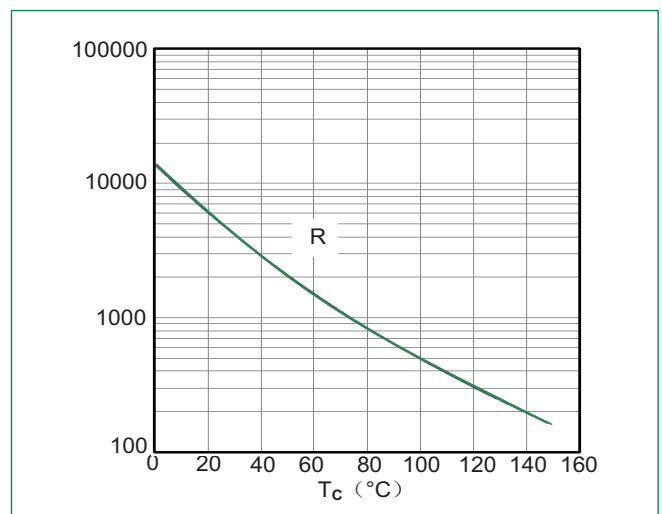

Figure 10: NTC Characteristics



Circuit Diagram



Dimensions-Package WB

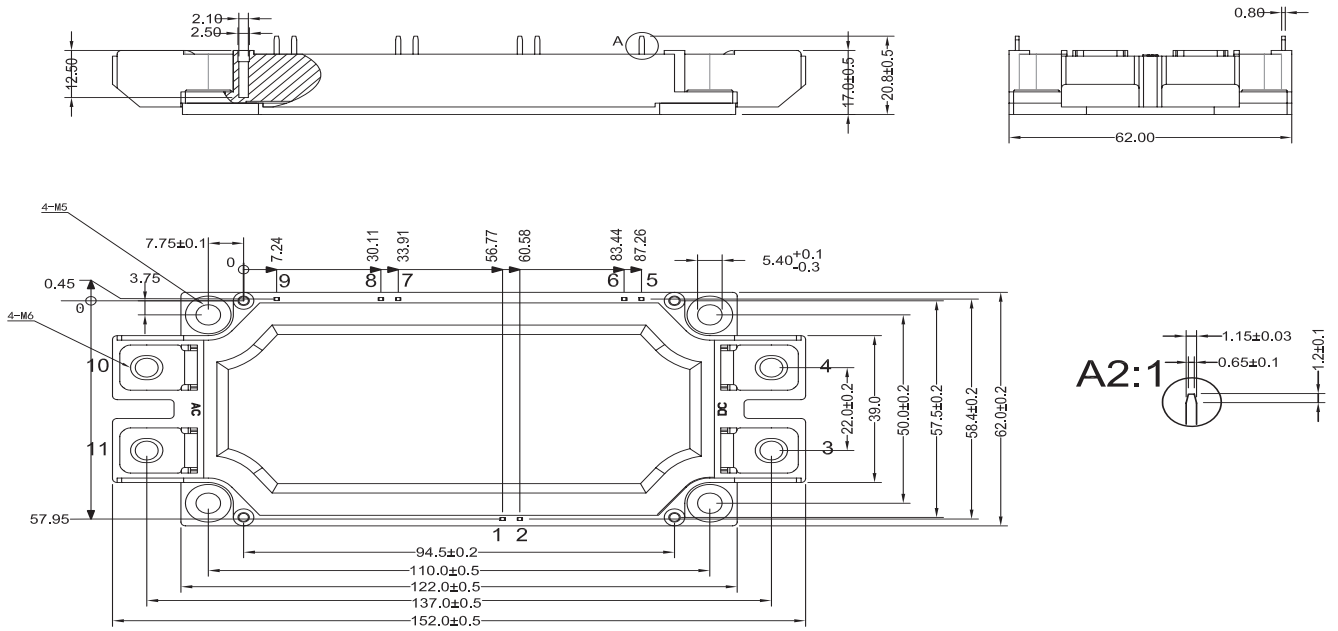

The foot pins are in gold / nickel coating

Packing Options

| Part Number | Marking | Weight | Packing Mode | M.O.Q |
|-----------------|-----------------|--------|--------------|-------|
| MG12450WB-BN2MM | MG12450WB-BN2MM | 350g | Bulk Pack | 60 |

Part Numbering System

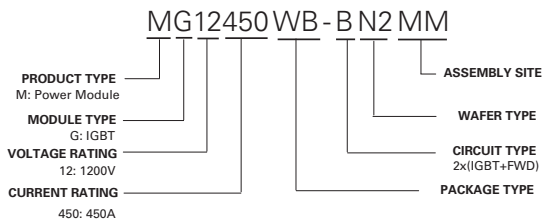

Part Marking System

