

### DST2080S

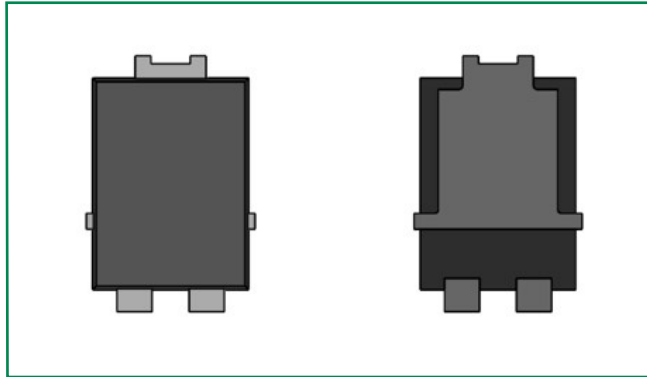

#### Pin out

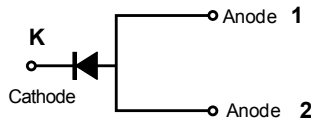

#### Description

Littelfuse DST series Ultra Low  $V_F$  Schottky Barrier Rectifier is designed to meet the general requirements of commercial and industry applications by providing high temperature, low leakage and lower  $V_F$  products.

It is suitable for high frequency switching mode power supply, free-wheeling diodes and polarity protection diodes.

#### Features

- Ultra low forward voltage drop
- High frequency operation
- MSL: Level 1 - unlimited
- High junction temperature capability
- Trench MOS Schottky technology
- Single die in TO-277B Package
- Pb-free E3 means 2nd level interconnect is Pb-free and the terminal finish material is tin(Sn) (IPC/ JEDEC J-STD-609A.01)

#### Applications

- Switching mode power supply
- DC/DC converters
- Free-Wheeling diodes
- Polarity Protection Diodes

#### Maximum Ratings

Parameters	Symbol	Test Conditions	Max	Unit
Peak Inverse Voltage	$V_{RWM}$	-	80	V
Average Forward Current (per device) *	$I_{F(AV)}$	50% duty cycle @ $T_A = 85^\circ\text{C}$ rectangular wave form	20	A
Peak One Cycle Non-Repetitive Surge Current (per leg)	$I_{FSM}$	8.3 ms, half Sine pulse	150	A

\* Mounted on 30 mm x 30 mm pad areas aluminum PCB

#### Electrical Characteristics

Parameters	Symbol	Test Conditions	Typ	Max	Unit
Forward Voltage Drop (per leg) *	$V_{F1}$	@10A, Pulse, $T_J = 25^\circ\text{C}$	0.52	-	V
		@20A, Pulse, $T_J = 25^\circ\text{C}$	0.64	0.70	
	$V_{F2}$	@10A, Pulse, $T_J = 125^\circ\text{C}$	0.46	-	
		@20A, Pulse, $T_J = 125^\circ\text{C}$	0.60	0.65	
Reverse Current (per leg) *	$I_{R1}$	@ $V_R = \text{rated } V_R, T_J = 25^\circ\text{C}$	22	300	$\mu\text{A}$
	$I_{R2}$	@ $V_R = \text{rated } V_R, T_J = 125^\circ\text{C}$	11	75	mA

\* Pulse Width < 300 $\mu\text{s}$ , Duty Cycle < 2%

### Thermal-Mechanical Specifications

Parameters	Symbol	Test Conditions	Max	Unit
Junction Temperature	$T_J$		-55 to +150	°C
Storage Temperature	$T_{stg}$		-55 to +150	°C
Typical Thermal Resistance Junction to Ambient	$R_{th,JA}$	DC operation	70	°C/W
Approximate Weight	wt		0.08	g
Case Style		TO-277B		

**Figure 1: Typical Forward Characteristics**

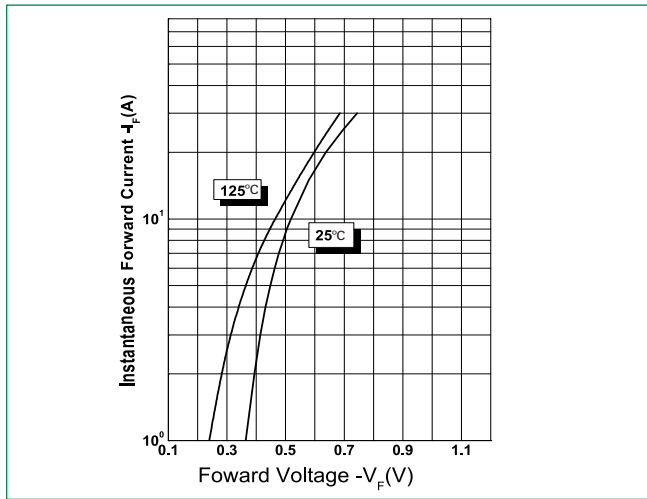

**Figure 2: Typical Reverse Characteristics**

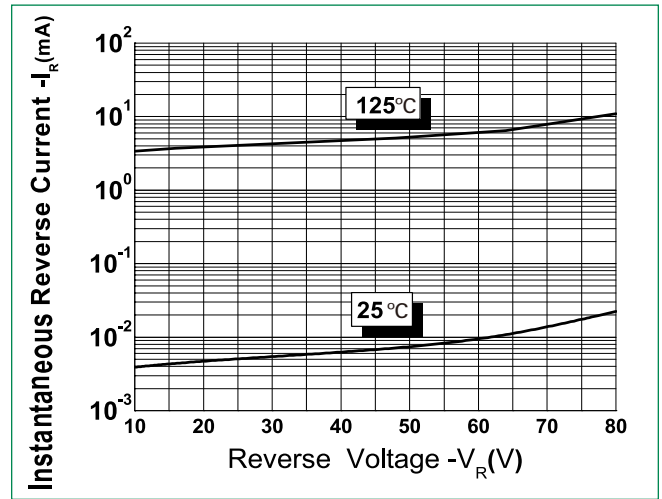

**Figure 3: Typical Junction Capacitance**

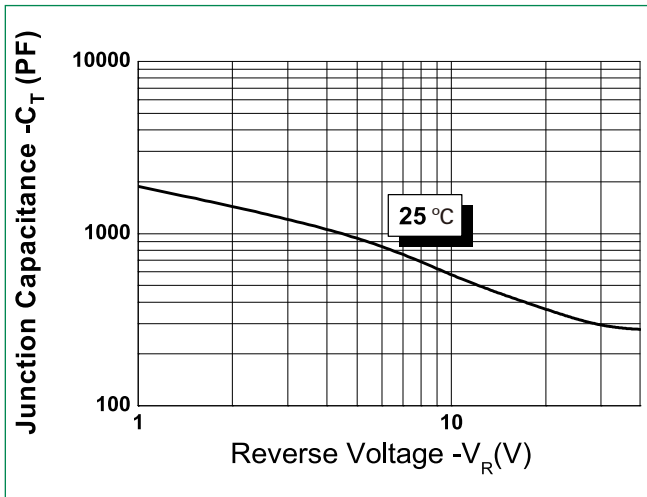

### Dimensions-TO-277B

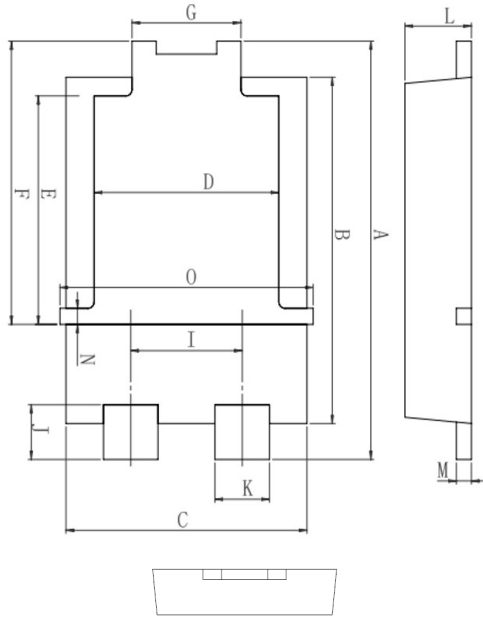

Symbol	Millimeters		
	Min	Typ	Max
<b>A</b>	6.30	6.50	6.70
<b>B</b>	5.28	5.38	5.48
<b>C</b>	3.88	3.98	4.08
<b>D</b>	2.90	3.05	3.20
<b>E</b>	3.40	3.55	3.70
<b>F</b>	4.20	4.40	4.60
<b>G</b>	1.70	1.80	1.90
<b>I</b>	1.74	1.84	1.94
<b>J</b>	0.65	0.85	1.05
<b>K</b>	0.85	0.90	0.95
<b>L</b>	0.95	1.10	1.25
<b>M</b>	0.20	0.25	0.30
<b>N</b>	0.25	0.40	0.55
<b>O</b>	4.00	4.05	4.25

### Mounting Pad Layout

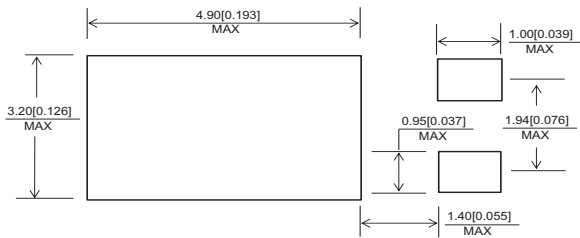

### Part Numbering and Marking System

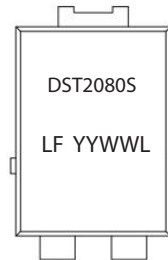

DST = Device Type  
 20 = Forward Current (20A)  
 80 = Reverse Voltage (80V)  
 S = Package Type  
 LF = Littelfuse  
 YY = Year  
 WW = Week  
 L = Lot Number

### Packing Options

Part Number	Marking	Packing Mode	M.O.Q
DST2080S	DST2080S	5000pcs / Reel	5000

### Carrier Tape & Reel Specification

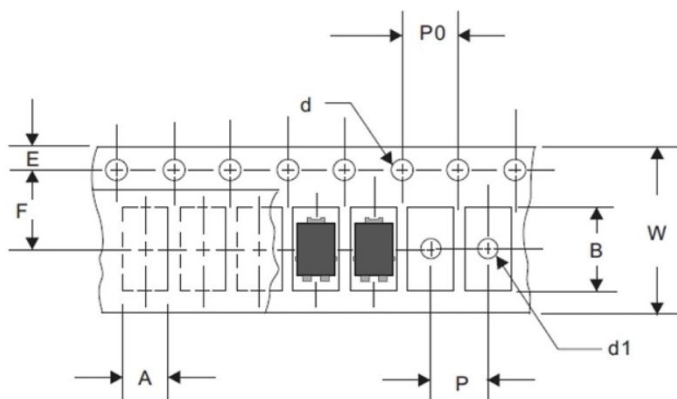

Symbol	Millimeters	
	Min	Max
<b>A</b>	4.28	4.48
<b>B</b>	6.80	7.00
<b>d</b>	1.40	1.60
<b>d1</b>	-	1.50
<b>E</b>	1.65	1.85
<b>F</b>	5.40	5.60
<b>P</b>	7.90	8.10
<b>P0</b>	3.90	4.10
<b>W</b>	11.70	12.30