

MBRD10100CT

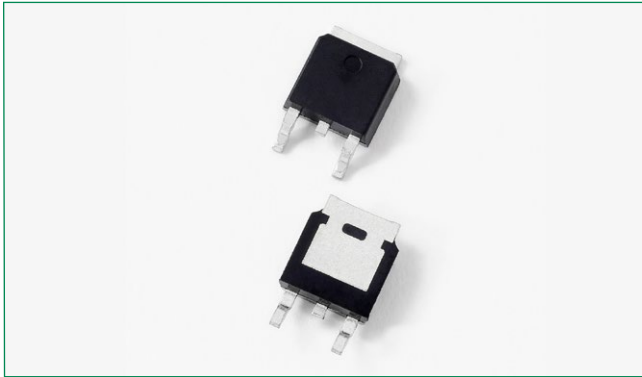

Pin out

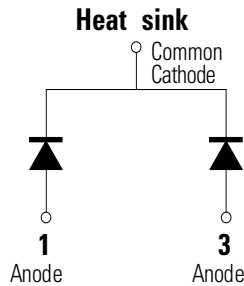

Description

Littelfuse MBR series Schottky Barrier Rectifier is designed to meet the general requirements of commercial applications by providing high temperature, low leakage and low V_F products. It is suitable for high frequency switching mode power supply, free-wheeling diodes and polarity protection diodes.

Features

- High junction temperature capability
- High frequency operation
- Guard ring for enhanced ruggedness and long term reliability
- Common cathode configuration in compact surface mount TO-252 package
- Low forward voltage drop

Applications

- Switching mode power supply
- DC/DC converters
- Free-wheeling diodes
- Polarity protection diodes

Maximum Ratings

Parameters	Symbol	Test Conditions	Max	Unit
Peak Inverse Voltage	V_{RWM}	-	100	V
Average Forward Current	$I_{F(AV)}$	50% duty cycle @ $T_C = 105^\circ\text{C}$, rectangular wave form	5 (per leg) 10 (total device)	A
Peak One Cycle Non-Repetitive Surge Current (per leg)	I_{FSM}	8.3ms, half Sine pulse	120	A

Electrical Characteristics

Parameters	Symbol	Test Conditions	Max	Unit
Forward Voltage Drop (per leg) *	V_{F1}	@ 5A, Pulse, $T_J = 25^\circ\text{C}$	0.85	V
	V_{F2}	@ 5A, Pulse, $T_J = 125^\circ\text{C}$	0.75	
Reverse Current (per leg) *	I_{R1}	@ $V_R = \text{rated } V_R$, $T_J = 25^\circ\text{C}$	1.0	mA
	I_{R2}	@ $V_R = \text{rated } V_R$, $T_J = 125^\circ\text{C}$	15	
Junction Capacitance (per leg)	C_T	@ $V_R = 5\text{V}$, $T_C = 25^\circ\text{C}$, $f_{SI} = 1\text{MHz}$	300	pF
Typical Series Inductance (per leg)	L_S	Measured lead to lead 5 mm from package body	8.0	nH
Voltage Rate of Change	dv/dt		10,000	V/ μs

* Pulse Width < 300 μs , Duty Cycle < 2%

Thermal-Mechanical Specifications

Parameters	Symbol	Test Conditions	Max	Unit
Junction Temperature	T_J		-55 to +150	°C
Storage Temperature	T_{stg}		-55 to +150	°C
Maximum Thermal Resistance Junction to Case (per leg)	R_{thJC}	DC operation	6.0	°C/W
Approximate Weight	wt		0.39	g
Case Style	DPAK(TO-252)			

Figure 1: Typical Forward Characteristics

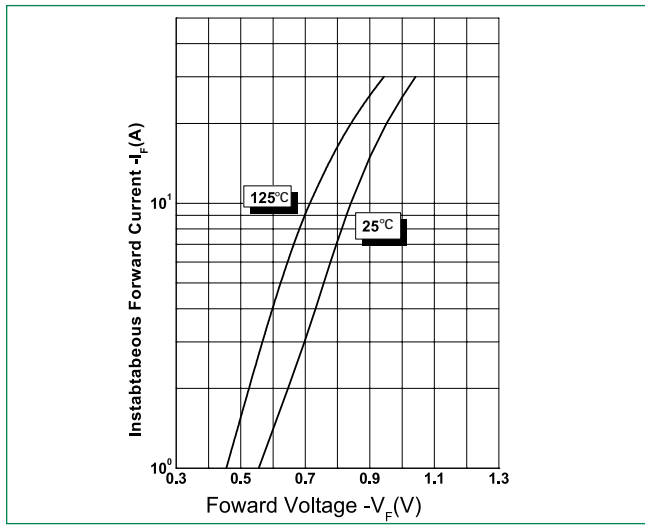

Figure 2: Typical Reverse Characteristics

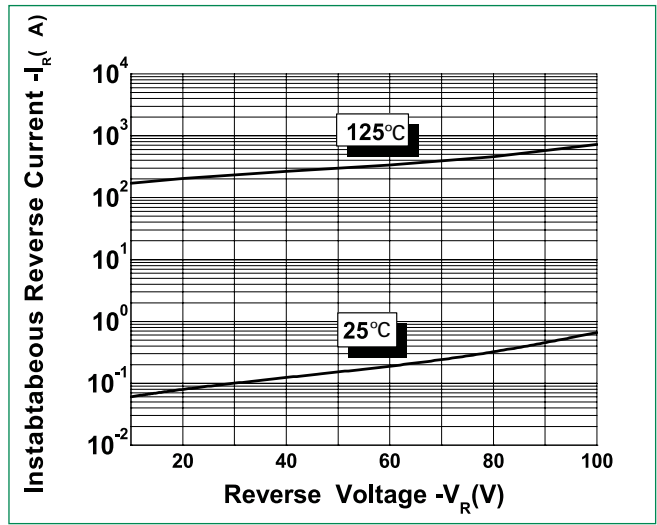
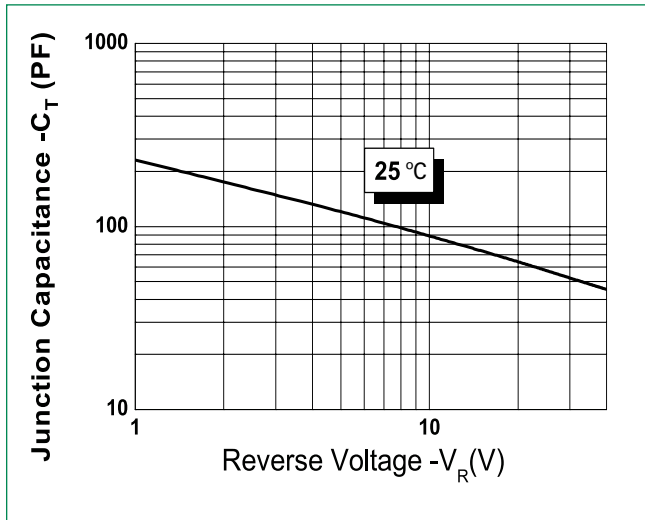
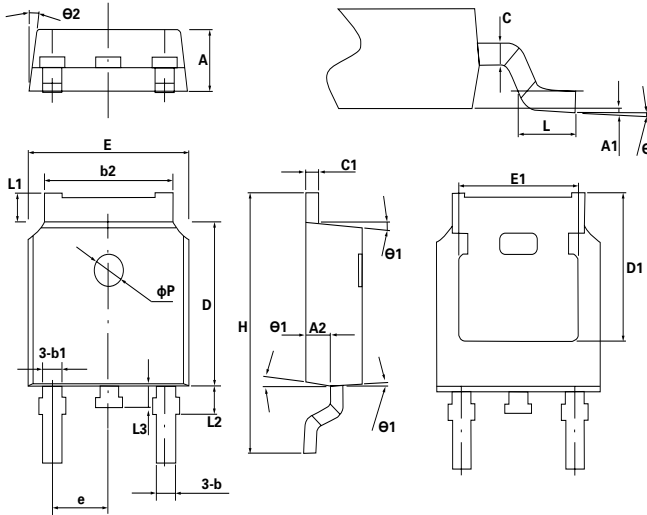

Figure 3: Typical Junction Capacitance



Dimensions-DPAK(TO-252)



Symbol	Min.	Typ.	Max..
A	2.2	2.3	2.38
A1	0	-	0.1
A2	0.9	1.01	1.1
b	0.71	0.76	0.86
b1		0.76	
b2	5.13	5.33	5.46
c	0.47	0.5	0.6
c1	0.47	0.5	0.6
D	6	6.1	6.2
D1	-	5.3	-
E	6.5	6.6	6.7
E1	-	4.8	-
e	2.286BSC		
H	9.7	10.1	10.4
L	1.4	1.5	1.7
L1	0.9	-	1.25
L2		1.05	
L3		0.8	
φP		1.2	
θ	0°	-	8°
θ1	5°	7°	9°
θ2	5°	7°	9°

Carrier Tape & Reel Specification

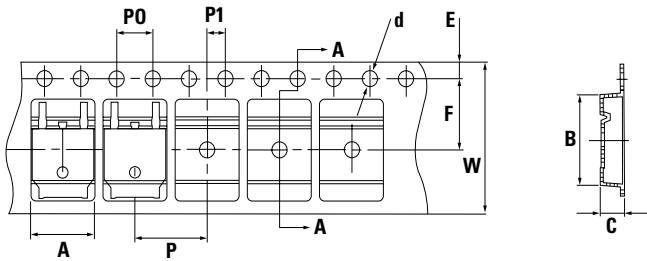

Symbol	Millimeters	
	Min	Max
A	6.80	7.00
B	10.40	10.60
C	2.60	2.80
d	ø1.45	ø1.65
E	1.65	1.85
F	7.40	7.60
P0	3.90	4.10
P	7.90	8.10
P1	1.90	2.10
W	15.50	16.50

Part Numbering and Marking System

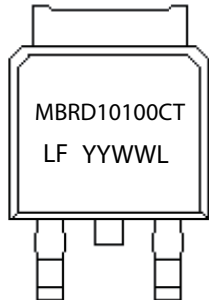

- MBR = Device Type
- D = Package type
- 10 = Forward Current (10A)
- 100 = Reverse Voltage (100V)
- CT = Configuration
- LF = Littelfuse
- YY = Year
- WW = Week
- L = Lot Number

Packing Options

Part Number	Marking	Packing Mode	M.O.Q
MBRD10100CT	MBRD10100CT	2500pcs / reel	2500