

MBRF20200CT

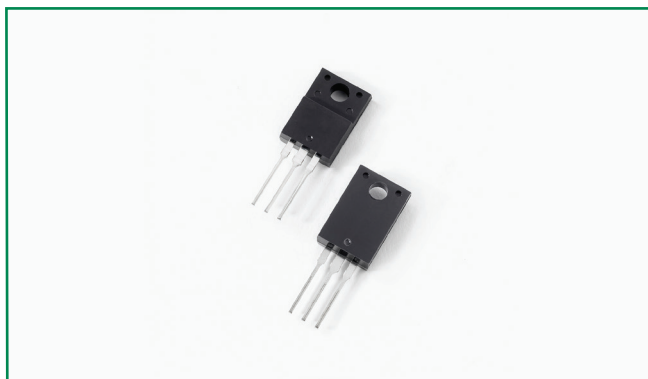

Pin out

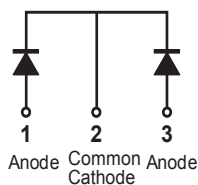

Description

Littelfuse MBR series Schottky Barrier Rectifier is designed to meet the general requirements of commercial applications by providing high temperature, low leakage and low V_F products.

It is suitable for high frequency switching mode power supply, free-wheeling diodes and polarity protection diodes.

Features

- High junction temperature capability
- Guard ring for enhanced ruggedness and long term reliability
- Low forward voltage drop
- High frequency operation
- Common cathode configuration in electrically isolated ITO-220AB package

Applications

- Switching mode power supply
- DC/DC converters
- Polarity protection diodes
- Free-wheeling diodes

Maximum Ratings

| Parameters | Symbol | Test Conditions | Max | Unit |
|---|-------------|--|-------------------------------|------|
| Peak Inverse Voltage | V_{RWM} | - | 200 | V |
| Average Forward Current | $I_{F(AV)}$ | 50% duty cycle @ $T_C = 105^\circ\text{C}$, rectangular wave form | 10(per leg) 20(per device) | A |
| Peak Repetitive Forward Current (per leg) | I_{FRM} | Rated $V_{R'}$ Square wave, 20KHz, @ $T_C = 90^\circ\text{C}$ | 20 | A |
| Peak One Cycle Non-Repetitive Surge Current (per leg) | I_{FSM} | 8.3 ms, half Sine pulse | 150 | A |

Electrical Characteristics

| Parameters | Symbol | Test Conditions | Max | Unit |
|---|-----------|---|--------|------------------|
| Forward Voltage Drop (per leg) * | V_{F1} | @ 10A, Pulse, $T_J = 25^\circ\text{C}$ | 0.95 | V |
| | V_{F2} | @ 10A, Pulse, $T_J = 125^\circ\text{C}$ | 0.85 | |
| Reverse Current at DC condition (per leg) | I_{R1} | @ $V_R = \text{rated } V_R$, $T_J = 25^\circ\text{C}$ | 1.0 | mA |
| Reverse Current (per leg) * | I_{R2} | @ $V_R = \text{rated } V_R$, $T_J = 125^\circ\text{C}$ | 50 | |
| Junction Capacitance (per leg) | C_T | @ $V_R = 5\text{V}$, $T_C = 25^\circ\text{C}$, $f_{SIG} = 1\text{MHz}$ | 300 | pF |
| Series Inductance (per leg) | L_S | Measured lead to lead 5 mm from package body | 8.0 | nH |
| Voltage Rate of Change | dv/dt | | 10,000 | V/ μs |
| RSM Isolation Voltage (t = 1.0 second, R. H. < =30%, $T_A = 25^\circ\text{C}$) | V_{ISO} | Clip mounting, the epoxy body away from the heatsink edge by more than 0.110" along the lead direction. | 4500 | V |
| | | Clip mounting, the epoxy body is inside the heatsink. | 3500 | |
| | | Screw mounting, the epoxy body is inside the heatsink. | 1500 | |

* Pulse Width < 300 μs , Duty Cycle < 2%

Thermal-Mechanical Specifications

| Parameters | Symbol | Test Conditions | Max | Unit |
|--|------------|-----------------|-------------|------|
| Junction Temperature | T_J | | -55 to +175 | °C |
| Storage Temperature | T_{stg} | | -55 to +175 | °C |
| Maximum Thermal Resistance Junction to Case (per leg) | R_{thJC} | DC operation | 4.5 | °C/W |
| Approximate Weight | wt | | 2 | g |
| Case Style | ITO-220AB | | | |

Figure 1: Typical Forward Characteristics

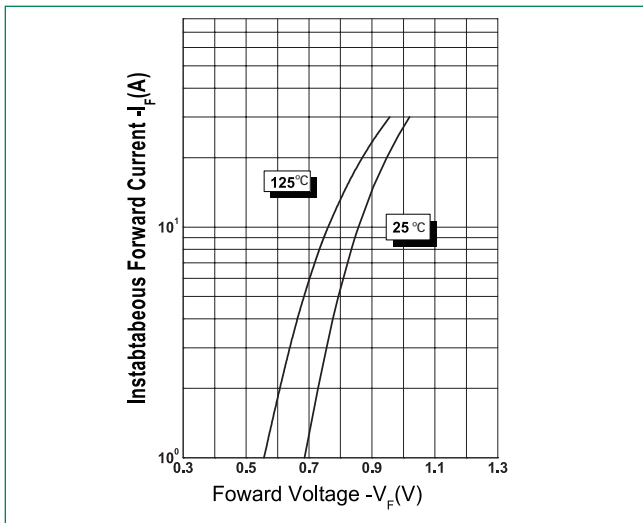

Figure 2: Typical Reverse Characteristics

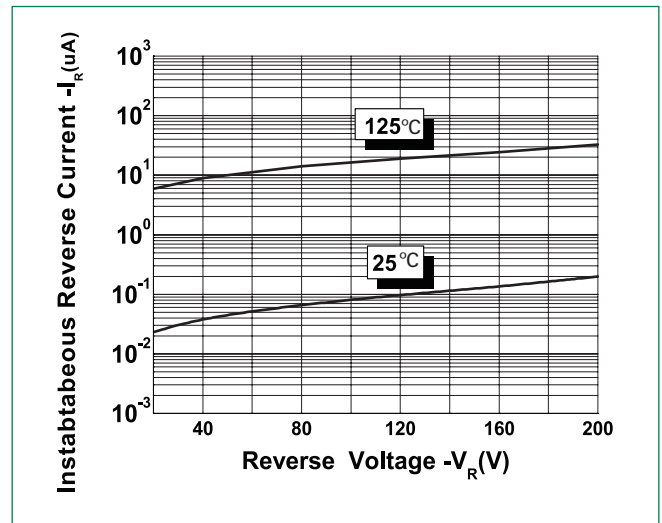
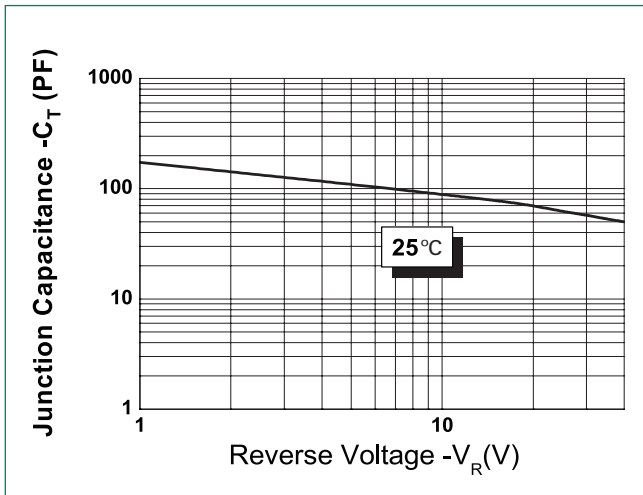

Figure 3: Typical Junction Capacitance



Dimensions- ITO-220AB



| Symbol | Millimeters | | |
|------------|-------------|-------|-------|
| | Min | Typ | Max |
| A | 4.30 | 4.50 | 4.70 |
| A1 | 1.10 | 1.30 | 1.50 |
| A2 | 2.80 | 3.00 | 3.20 |
| A3 | 2.50 | 2.70 | 2.90 |
| b | 0.50 | 0.60 | 0.75 |
| b1 | 1.10 | 1.20 | 1.35 |
| b2 | 1.50 | 1.60 | 1.75 |
| b3 | 1.20 | 1.30 | 1.45 |
| b4 | 1.60 | 1.70 | 1.85 |
| c | 0.55 | 0.60 | 0.75 |
| D | 14.80 | 15.00 | 15.20 |
| E | 9.96 | 10.16 | 10.36 |
| e | | 2.55 | |
| e1 | | 5.10 | |
| H1 | 6.50 | 6.70 | 6.90 |
| L | 12.70 | 13.20 | 13.70 |
| L1 | 1.60 | 1.80 | 2.00 |
| L2 | 0.80 | 1.00 | 1.20 |
| L3 | 0.60 | 0.80 | 1.00 |
| ØP1 | 3.30 | 3.50 | 3.70 |
| ØP2 | 2.99 | 3.19 | 3.39 |
| Q | 2.50 | 2.70 | 2.90 |
| Ø1 | | 5° | |
| Ø2 | | 4° | |
| Ø3 | | 10° | |
| Ø4 | | 5° | |
| Ø5 | | 5° | |

Packing Options

| Part Number | Marking | Packing Mode | M.O.Q. |
|-------------|-------------|--------------|--------|
| MBRF20200CT | MBRF20200CT | 50pcs / Tube | 1000 |

Tube Specification

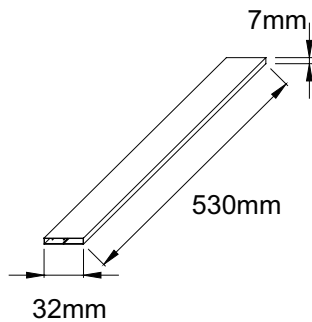

Part Numbering and Marking System

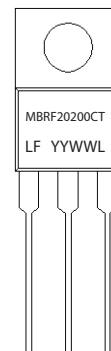

- MBR = Device Type
- F = Package type
- 20 = Forward Current (20A)
- 200 = Reverse Voltage (200V)
- CT = Configuration
- LF = Littelfuse
- YY = Year
- WW = Week
- L = Lot Number