



Description

Thyristor AC controller module for mains frequency (50Hz/60Hz), utilizing two SCR dies in anti-parallel configuration for applications such as heating.

Robust SOT227B package with isolation voltage 2500V minimum

Features & Benefits

- Compact and robust SOT227B package
- High current handling capability, $I_{T(RMS)}=90A$
- Glass – passivated junctions
- Surge capability up to 950 A

Applications

High power electrical tankless water heater

Agency Approval

Agency	Agency File Number
	E71639

Main Features

Symbol	Value	Unit
$I_{T(RMS)}$	90	A
V_{DRM}/V_{RRM}	600	V
I_{GT}	50	mA

Schematic Symbol

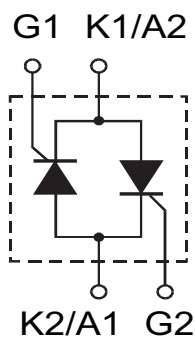

Absolute Maximum Ratings

Symbol	Parameter	Test Conditions	Value	Unit
$I_{T(RMS)}$	On-State RMS Current - 360° as module	$T_C = 92^\circ\text{C}$	90	A
	On-State RMS Current - 180° as single SCR		65	
$I_{T(AV)}$	Average On-State Current - 360° as module	$T_C = 92^\circ\text{C}$	64	A
	Average On-State Current - 180° as single SCR		41	
I_{TSM}	Peak Non-Repetitive Surge Current, single cycle 60Hz		950	A
I^2t	I^2t Value for fusing	$t_p = 8.3\text{ms}$	3745	A^2s
di/dt	Critical Rate-of-Rise of On-State Current	$I_G = 150\text{mA}$, $f=60\text{Hz}$, $T_J = 125^\circ\text{C}$	200	$\text{A}/\mu\text{s}$
P_{GM}	Peak Gate Power Dissipation	$T_J = 125^\circ\text{C}$, $T_p=30\mu\text{s}$	10	W
		$T_J = 125^\circ\text{C}$, $T_p=300\mu\text{s}$	5	
$P_{G(AV)}$	Average Gate Power Dissipation	$T_J = 125^\circ\text{C}$	1.0	W
T_{stg}	Storage Junction Temperature Range		-40 to 150	$^\circ\text{C}$
T_J	Operating junction Temperature Range		-40 to 125	$^\circ\text{C}$

Electrical Characteristics ($T_J = 25^\circ\text{C}$, unless otherwise specified)

Symbol	Parameter	Test Conditions	Value		Unit
			min.	max.	
I_{GT}	DC Gate Trigger Current	$V_D = 12\text{V}$; $R_L = 30\ \Omega$	5	50	mA
V_{GT}	DC Gate Trigger Voltage			1.6	V
I_H	Holding Current	$I_T=400\text{mA}$ (initial)		80	mA
dv/dt	Critical Rate-of-Rise of Off-State Voltage	$T_J = 125^\circ\text{C}$, $V_D = V_{DRM}/V_{RRM}$, Exponential Waveform, Gate Open	500		$\text{V}/\mu\text{s}$
t_q	Turn-Off Time	$I_T=2\text{A}$, $T_p=50\mu\text{s}$, $dv/dt=5\text{V}/\mu\text{s}$, $di/dt=-30\text{A}/\mu\text{s}$		35	μs
t_{gt}	Turn-On Time	$I_G = 150\text{mA}$, $PW = 15\ \mu\text{s}$, $I_T = 130\text{A(pk)}$		3	μs

Static Characteristics

Symbol	Parameter	Test Conditions	Value	Unit	
V_{TM}	Peak On-State Voltage	$I_T = 130\ \text{A Peak}$, $T_p=380\mu\text{s}$	MAX.	1.8	V
I_{DRM} I_{RRM}	$V_D = V_{DRM}/V_{RRM}$	$T_J = 25^\circ\text{C}$	MAX.	20	μA
		$T_J = 125^\circ\text{C}$		3000	μA

Thermal Resistances

Symbol	Parameter	Value	Unit
$R_{\theta(J-C)}$	Thermal Resistance, Junction to Case	0.3	$^\circ\text{C}/\text{W}$

Figure 1: Normalized DC Gate Trigger Current vs. Junction Temperature

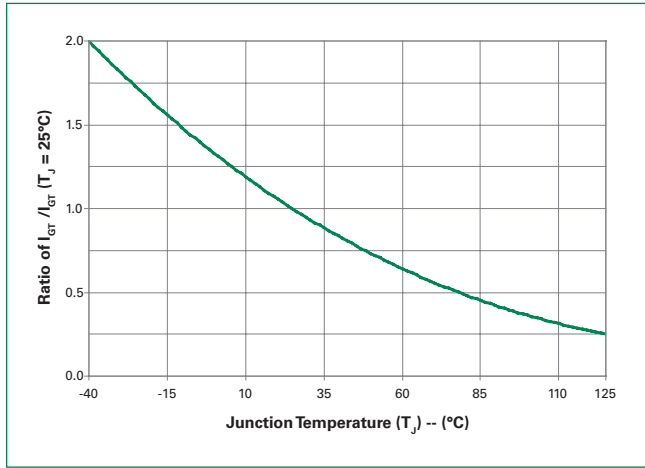

Figure 2: Normalized DC Gate Trigger Voltage vs. Junction Temperature

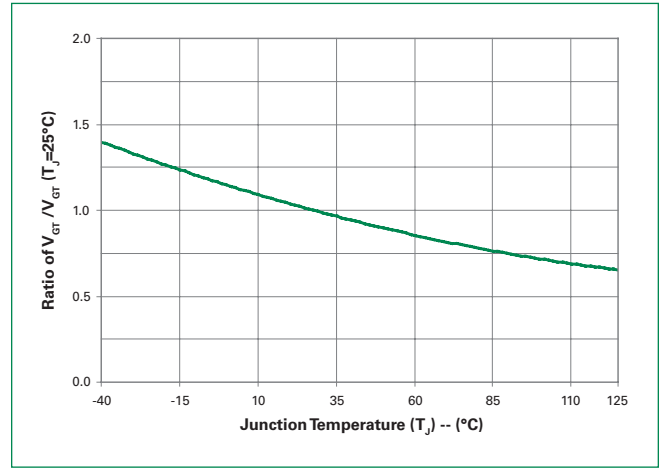

Figure 3: Normalized DC Holding Current vs. Junction Temperature

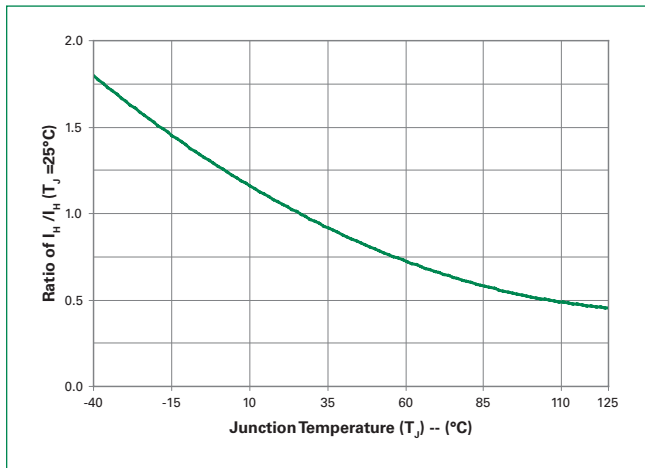

Figure 4: On-State Current vs. On-State Voltage (Typical, per SCR)

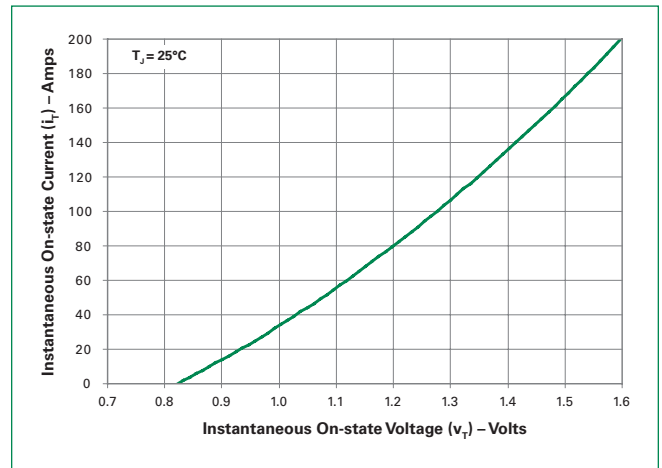

Figure 5: Power Dissipation (Typical) vs. RMS On-State Current per SCR

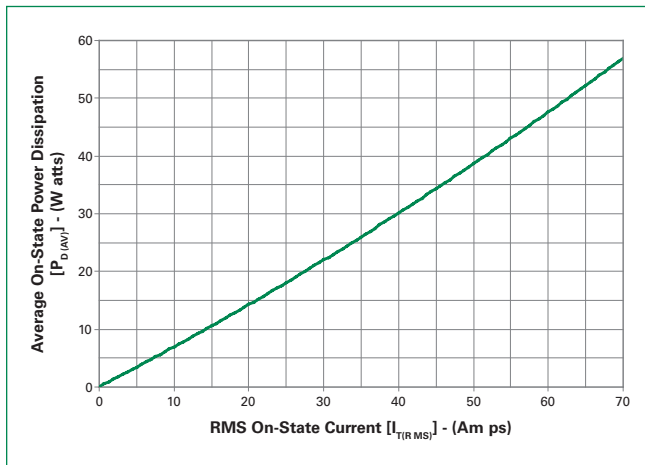

Figure 6: Maximum Allowable Case Temperature vs. RMS On-State Current per module

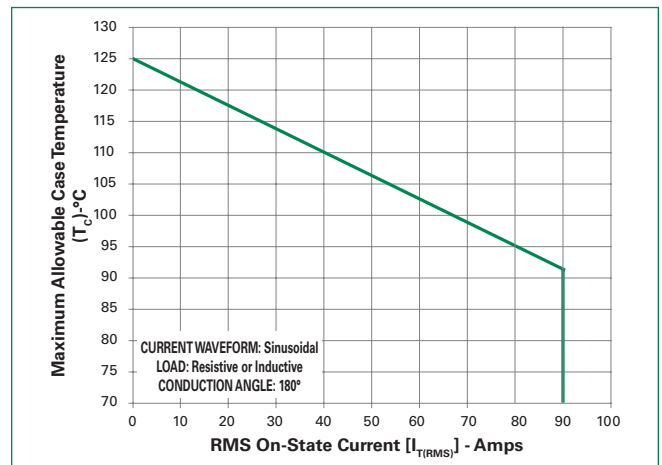

Figure 7: Maximum Allowable Case Temperature vs. Average On-State Current per module

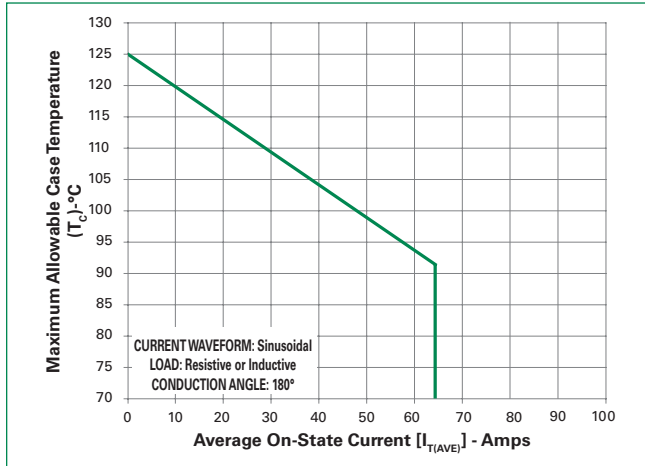
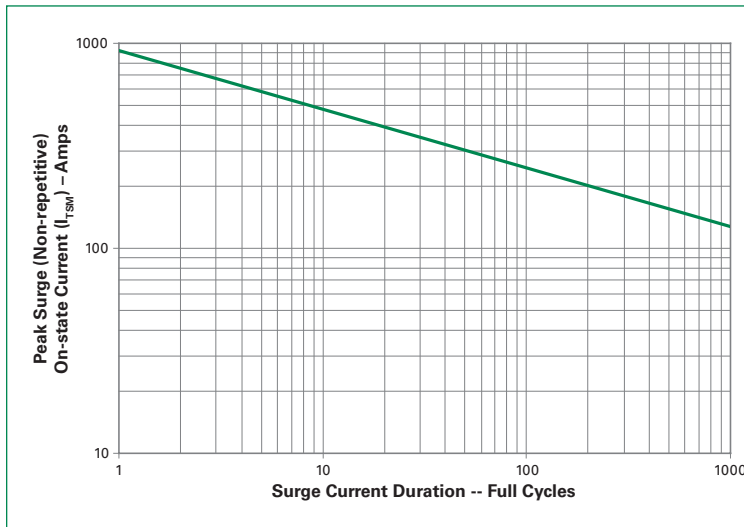

Figure 7: Surge Peak On-State Current vs. Number of Cycles



SUPPLY FREQUENCY: 60 Hz Sinusoidal
LOAD: Resistive
RMS On-State Current [$I_{T(RMS)}$]: Maximum Rated Value at Specified Case Temperature

Notes:

1. Gate control may be lost during and immediately following surge current interval.
2. Overload may not be repeated until junction temperature has returned to steady-state rated value.

Physical Specifications

Terminal Finish	100% Nickel Plated
Body	UL recognized epoxy meeting flammability classification 94V-0
Lead Material	Copper Alloy

Design Considerations

Careful selection of the correct device for the application's operating parameters and environment will go a long way toward extending the operating life of the Thyristor. Good design practice should limit the maximum continuous current through the main terminals to 75% of the device rating. Other ways to ensure long life for a power discrete semiconductor are proper heat sinking and selection of voltage ratings for worst case conditions. Overheating, overvoltage (including dv/dt), and surge currents are the main killers of semiconductors. Correct mounting, soldering, and forming of the leads also help protect against component damage.

Environmental Specifications

Test	Specifications and Conditions
AC Blocking	MIL-STD-750, M-1040, Cond A Applied Peak AC voltage @ 125°C for 1008 hours
Intermittent Operational Life	MIL-STD-750, Method 1037, 15000cycles, $\Delta T_J \geq 100^\circ\text{C}$
Temperature/Humidity	EIA / JEDEC, JESD22-A101 504 hours; 160V - DC: 85°C; 85% rel humidity
High Temp Storage	MIL-STD-750, M-1031, 1008 hours; 150°C
Low-Temp Storage	1008 hours; -40°C
Temperature Cycling	MIL-STD-750, M-1051, 20 cycles; -25°C to +125°C; 15-min dwell-time

Dimensions

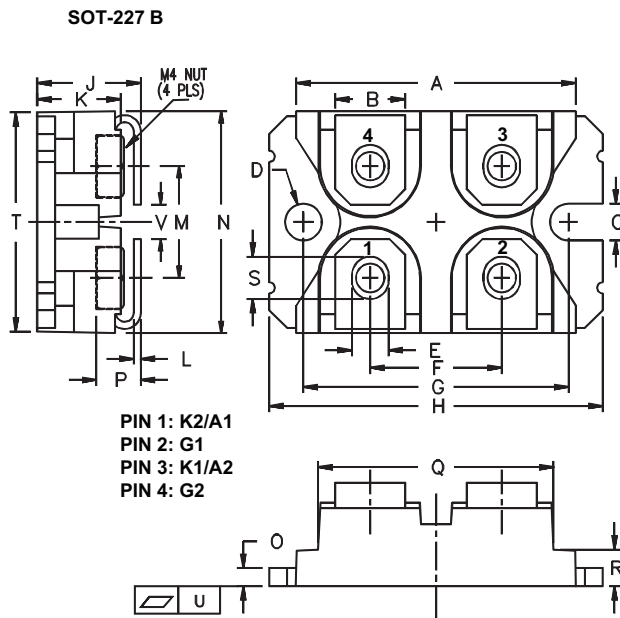

Note: M4x7.5MM screw, 4 screws per unit.

Dimension	Inches		Millimeters	
	Min	Max	Min	Max
A	1.240	1.256	31.50	31.90
B	0.307	0.323	7.80	8.20
C	0.161	0.169	4.09	4.29
D	0.161	0.169	4.09	4.29
E	0.161	0.169	4.09	4.29
F	0.587	0.595	14.91	15.11
G	1.186	1.193	30.12	30.30
H	1.489	1.505	37.80	38.20
J	0.460	0.481	11.68	12.22
K	0.351	0.378	8.92	9.60
L	0.030	0.033	0.76	0.84
M	0.497	0.507	12.62	12.88
N	0.990	1.001	25.15	25.42
O	0.078	0.084	1.98	2.13
P	0.193	0.232	4.90	5.89
Q	1.045	1.059	26.54	26.90
R	0.155	0.174	3.94	4.42
S	0.186	0.191	4.72	4.85
T	0.968	0.987	24.50	25.07
U	0	0.005	0	0.127
V	0.130	0.180	3.30	4.57

Packing Options

Part Number	Weight	Packing Mode	Base Quantity
MS0690J-DL1TE	30g	Tube	160

Part Numbering System

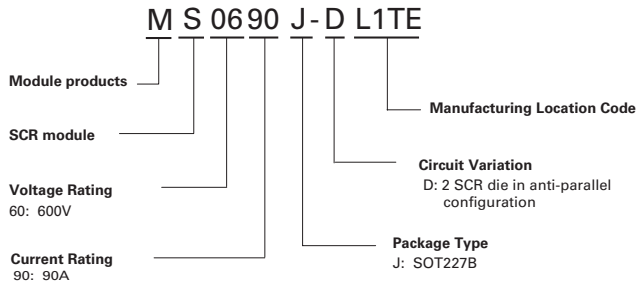

Part Marking System

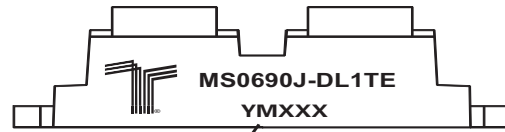

Date Code Marking
 Y: Year Code
 M: Month Code
 XXX: Lot Trace Code