

Ultrafast Recovery Rectifier

DURF2040CT, 2x 10A, 400V, ITO-220AB, Common Cathode



Expertise Applied | Answers Delivered

DURF2040CT

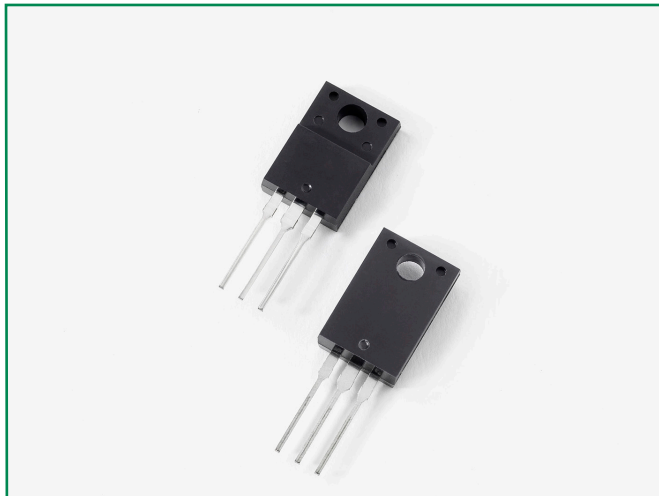

Description

Littelfuse DUR series Ultrafast Recovery Rectifier is designed to meet the general requirements of commercial applications by providing low T_{rr} , high-temperature, low-leakage and low forward voltage drop products. It is suitable for output rectifier, free-wheeling or boost diode in high-frequency power switching application such as switch mode power supply and DC-DC converters.

Features

- Ultra-fast switching
 - Low reverse leakage current
 - High surge current capability
 - Low forward voltage drop
 - Common Cathode
- configuration in electrically isolated ITO-220AB package
- Pb-free E3 means 2nd level interconnect is Pb-free and the terminal finish material is tin(Sn) (IPC/JEDEC J-STD-609A.01)

Circuit Diagram

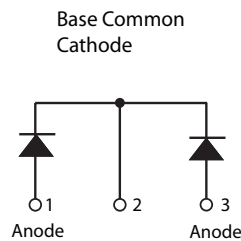

Applications

- Output rectifiers in switch mode power supplies (SMPS) and DC to DC converters
- Free-wheeling diode or boost diode in converters and motor control circuits
- Anti-parallel diode for high frequency switching devices such as IGBT
- Uninterruptible Power Supplies (UPS)
- Inductive heating and melting
- Ultrasonic cleaners and welders

Maximum Ratings

Characteristics	Symbol	Conditions	Max.	Unit
Peak Inverse Voltage	V_{RWM}	-	400	V
Average Forward Current	$I_{F(AV)}$	50% duty cycle @ $T_C = 100^\circ\text{C}$, rectangular wave form	10 (Per Leg)	A
			20(Total Device)	
Peak One Cycle Non-Repetitive Surge Current (Per Leg)	I_{FSM}	8.3 ms, half sine pulse	125	A

Electrical Characteristics

Characteristics	Symbol	Conditions	Max.	Unit
Forward Voltage Drop ¹	V_{F1}	@10A, Pulse, $T_J = 25^\circ\text{C}$	1.3	V
	V_{F2}	@10A, Pulse, $T_J = 125^\circ\text{C}$	1.2	V
Reverse Current ¹	I_{R1}	@ $V_R = \text{Rated } V_R, T_J = 25^\circ\text{C}$	10	μA
	I_{R2}	@ $V_R = \text{Rated } V_R, T_J = 125^\circ\text{C}$	500	μA
Reverse Recovery Time	t_{rr1}	$I_F=500\text{mA}, I_R=1\text{A}, \text{ and } I_{rm}=250\text{mA}$	45	ns

Footnote 1: Pulse Width < 300 μs , Duty Cycle <2%

Thermal-Mechanical Specifications

Characteristics	Symbol	Conditions	Specification	Unit
Junction Temperature	T_J	-	-55 to +150	°C
Storage Temperature	T_{stg}	-	-55 to +150	°C
Typical Thermal Resistance Junction to Case	$R_{\theta JC}$	DC operation	5.0	°C/W
Approximate Weight	wt	-	2.0	g
Case Style	-	ITO-220AB	-	-

Figure 1: Typical Forward Characteristics

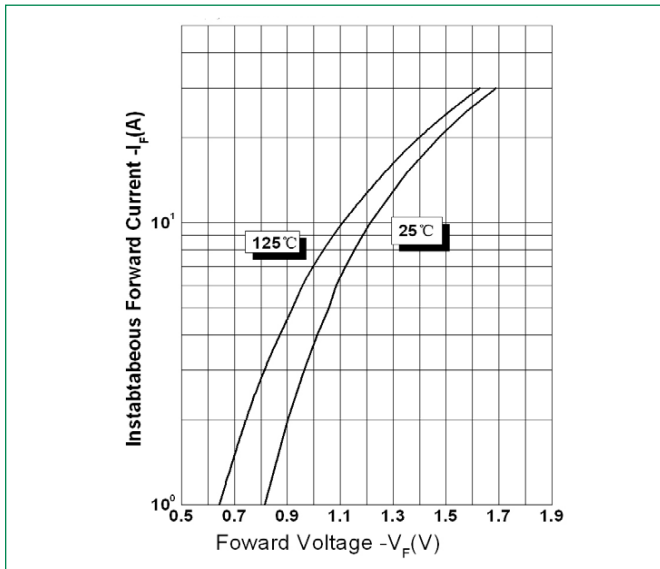

Figure 2: Typical Reverse Characteristics

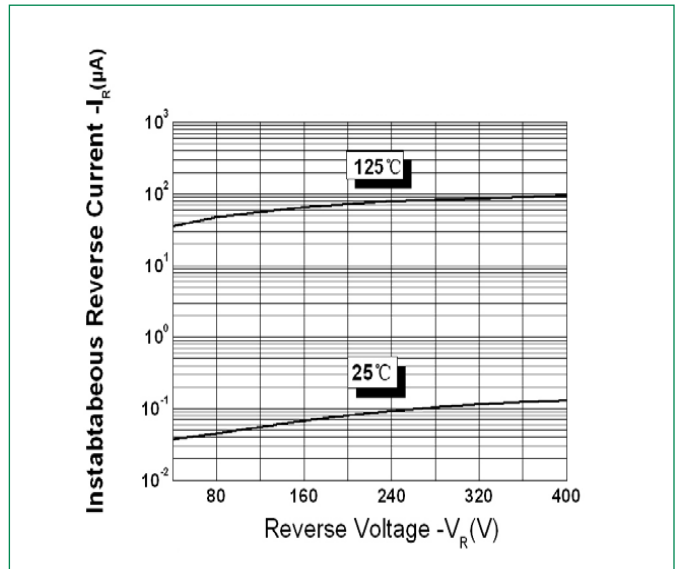
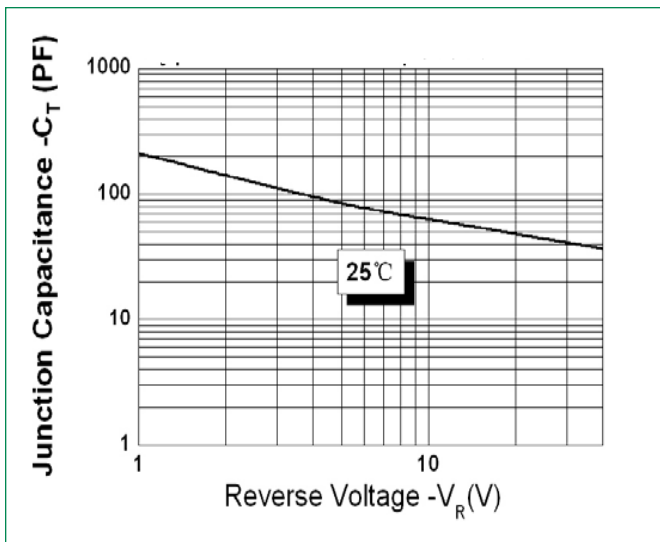
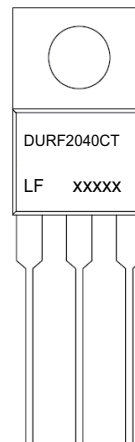

Figure 3: Typical Junction Capacitance



Part Numbering and Marking System



- *xxxxx is YYWWL
- DUR = Device Type
 - F = Package type
 - 20 = Forward Current (20A)
 - 40 = Reverse Voltage (400V)
 - CT = Configuration
 - LF = Littelfuse
 - YY = Year
 - WW = Week
 - L = Lot Number

Ultrafast Recovery Rectifier

DURF2040CT, 2x 10A, 400V, ITO-220AB, Common Cathode

Packing Options

Part Number	Marking	Packing Mode	M.O.Q
DURF2040CT	DURF2040CT	50pcs /Tube	1000

Dimensions-Package ITO-220AB

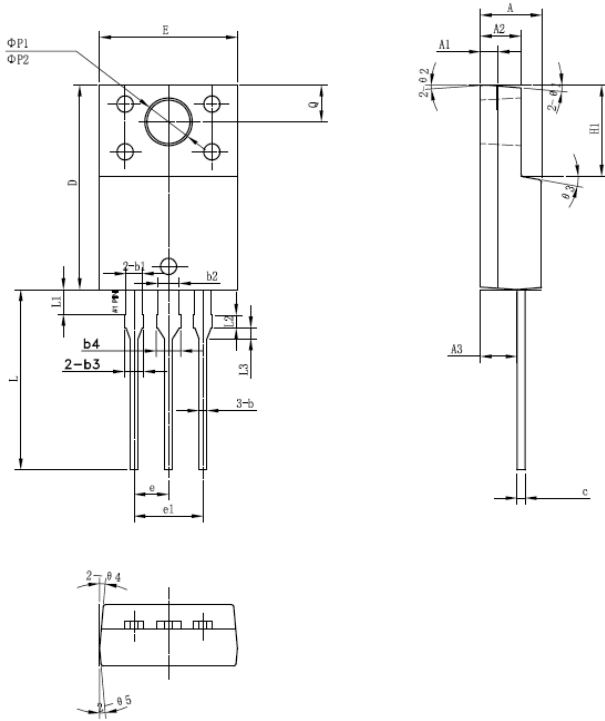

Symbol	Millimeters		
	Min	Typ	Max
A	4.30	4.50	4.70
A1	1.10	1.30	1.50
A2	2.80	3.00	3.20
A3	2.50	2.70	2.90
b	0.50	0.60	0.75
b1	1.10	1.20	1.35
b2	1.50	1.60	1.75
b3	1.20	1.30	1.45
b4	1.60	1.70	1.85
c	0.55	0.60	0.75
D	14.80	15.00	15.20
E	9.96	10.16	10.36
e		2.55	
e1		5.10	
H1	6.50	6.70	6.90
L	12.70	13.20	13.70
L1	1.60	1.80	2.00
L2	0.80	1.00	1.20
L3	0.60	0.80	1.00
$\phi P1$	3.30	3.50	3.70
$\phi P2$	2.99	3.19	3.39
Q	2.50	2.70	2.90
$\theta 1$		5°	
$\theta 2$		4°	
$\theta 3$		10°	
$\theta 4$		5°	
$\theta 5$		5°	

Tube Specification ITO-220AB

