

**MCR310**

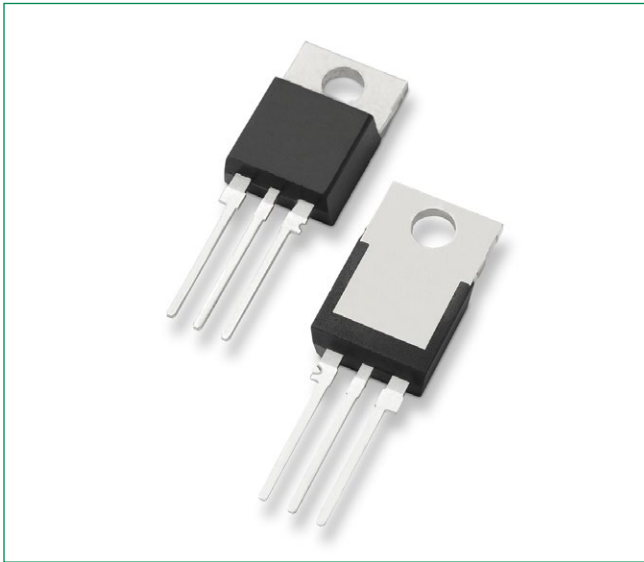

**Description**

Designed for industrial and consumer applications such as temperature, light and speed control; process and remote controls; warning systems; capacitive discharge circuits and MPU interface.

**Features**

- Center Gate Geometry for Uniform Current Density
- All Diffused and Glass-Passivated Junctions for Parameter Uniformity and Stability
- Small, Rugged, Thermowatt Construction for Low Thermal Resistance, High Heat Dissipation and Durability
- Low Trigger Currents, 200  $\mu$ A Maximum for Direct Driving from Integrated Circuits
- Pb-Free Packages are Available

**Pin Out**

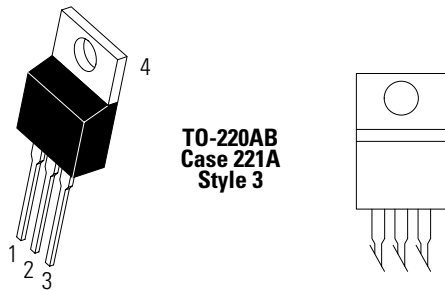

**Functional Diagram**

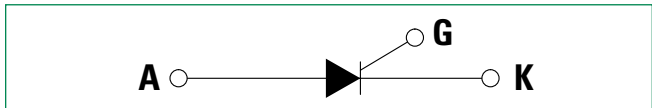

**Additional Information**

**Datasheet**

**Resources**

**Samples**

### Maximum Ratings ( $T_J = 25^\circ\text{C}$ unless otherwise noted)

Rating	Part Number	Symbol	Value	Unit
Peak Repetitive Off-State Voltage (Note 1) ( $T_J = -40$ to $+125^\circ\text{C}$ , Gate Open)	MCR310-6 MCR310-8 MCR310-10	$V_{\text{DRM}}$ $V_{\text{RRM}}$	400 600 800	V
On-State RMS Current ( $T_C = 75^\circ\text{C}$ )		$I_{\text{T(RMS)}}$	10	A
Peak Non-Repetitive Surge Current (1/2 Cycle, 60 Hz, $T_J = -40$ to $110^\circ\text{C}$ )		$I_{\text{TSM}}$	100	A
Circuit Fusing ( $t = 8.3$ ms)		$I^2t$	40	$\text{A}^2\text{sec}$
Peak Gate Voltage ( $t \leq 10$ $\mu\text{s}$ )		$V_{\text{GM}}$	$\pm 5$	V
Peak Gate Current ( $t \leq 10$ $\mu\text{s}$ )		$I_{\text{GM}}$	1	A
Peak Gate Power ( $t \leq 10$ $\mu\text{s}$ )		$P_{\text{GM}}$	5	W
Average Gate Power		$P_{\text{G(AV)}}$	0.75	W
Operating Junction Temperature Range		$T_J$	-40 to +110	$^\circ\text{C}$
Storage Temperature Range		$T_{\text{stg}}$	-40 to +150	$^\circ\text{C}$
Mounting Torque		–	8.0	in. lb.

Stresses exceeding Maximum Ratings may damage the device. Maximum Ratings are stress ratings only. Functional operation above the Recommended Operating Conditions is not implied. Extended exposure to stresses above the Recommended Operating Conditions may affect device reliability.

- VDRM and VRRM for all types can be applied on a continuous basis. Ratings apply for zero or negative gate voltage; however, positive gate voltage shall not be applied concurrent with negative potential on the anode. Blocking voltages shall not be tested with a constant current source such that the voltage ratings of the devices are exceeded.

### Thermal Characteristics

Characteristic	Symbol	Value	Unit
Thermal Resistance, Junction-to-Case	$R_{\theta\text{JC}}$	2.2	$^\circ\text{C}/\text{W}$
Thermal Resistance, Junction-to-Ambient	$R_{\theta\text{JA}}$	60	

### Electrical Characteristics ( $T_C = 25^\circ\text{C}$ , $R_{\text{GK}} = 1$ k $\Omega$ unless otherwise noted)

Characteristic	Symbol	Min	Typ	Max	Unit	
Peak Forward Blocking Current (Note 1) ( $T_J = 110^\circ\text{C}$ , $V_D = \text{Rated } V_{\text{DRM}}$ )	$I_{\text{DRM}}$	$T_C = 110^\circ\text{C}$	–	–	500	$\mu\text{A}$
		$T_C = 25^\circ\text{C}$	–	–	10	
Peak Reverse Blocking Current (Note 1) ( $T_J = 110^\circ\text{C}$ , $V_R = \text{Rated } V_{\text{DRM}}$ )	$I_{\text{RRM}}$	$T_C = 110^\circ\text{C}$	–	–	500	$\mu\text{A}$
		$T_C = 25^\circ\text{C}$	–	–	10	
On-State Voltage ( $I_{\text{TM}} = 20$ A Peak, Pulse Width $\leq 1$ ms, Duty Cycle $\leq 2\%$ )	$V_{\text{TM}}$	–	1.7	2.2	V	
Gate Trigger Current Continuous dc (Note 2) ( $V_D = 12$ Vdc, $R_L = 100$ $\Omega$ )	$I_{\text{GT}}$	–	30	200	$\mu\text{A}$	
Gate Trigger Voltage, Continuous dc ( $V_D = \text{Rated } V_{\text{DRM}}$ , $R_L = 10$ k $\Omega$ , $T_J = 110^\circ\text{C}$ )	$V_{\text{GT}}$	– 0.1	0.5 –	1.5 –	mA	
Holding Current ( $V_D = 12$ V, $I_{\text{TM}} = 100$ mA)	$I_{\text{H}}$	–	–	6	mA	
Critical Rate of Rise of Forward Blocking Voltage ( $V_D = \text{Rated } V_{\text{DRM}}$ , $T_J = 110^\circ\text{C}$ , Exponential Waveform)	$dv/dt$	–	10	–	V/ $\mu\text{s}$	
Gate Controlled Turn-On Time ( $V_D = \text{Rated } V_{\text{DRM}}$ , $I_{\text{TM}} = 20$ A, $I_G = 2$ mA)	$t_{\text{gt}}$	–	1	–	$\mu\text{s}$	

- Ratings apply for negative gate voltage or RGK = 1 k $\Omega$ . Devices shall not have a positive gate voltage concurrently with a negative voltage on the anode. Devices should not be tested with a constant current source for forward and reverse blocking capability such that the voltage applied exceeds the rated blocking voltage.

2. Does not include RGK current.

**Figure 1. Typical RMS Current Derating**

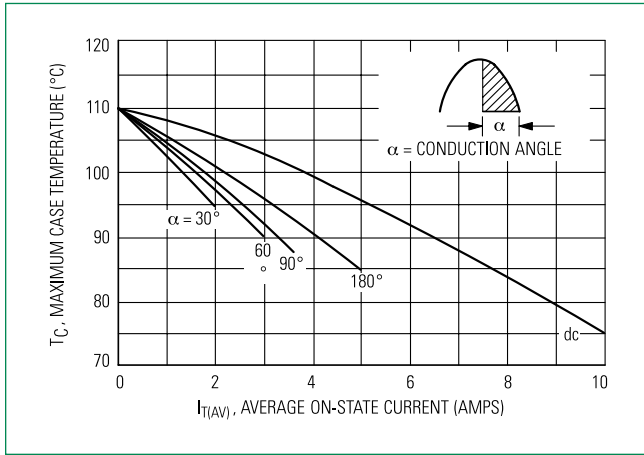

**Figure 2. Peak Capacitor Discharge Current Derating**

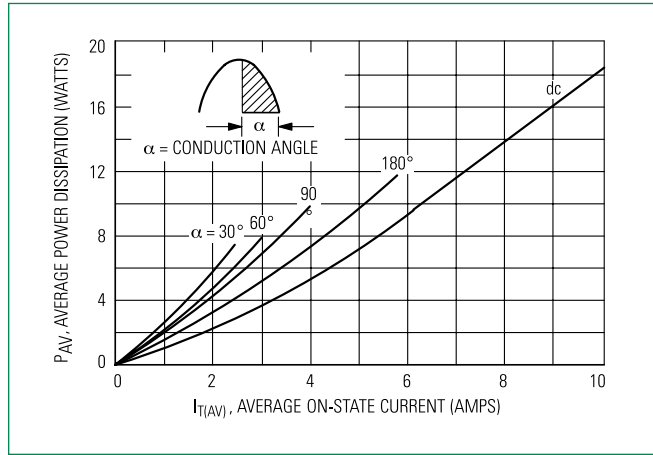

**Figure 3. Current Derating**

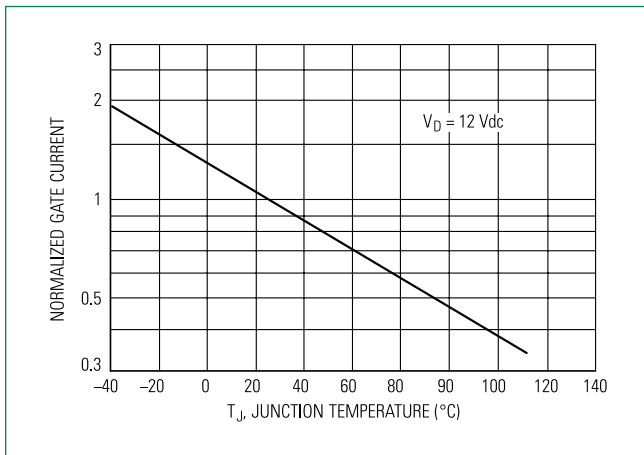

**Figure 4. Maximum Power Dissipation**

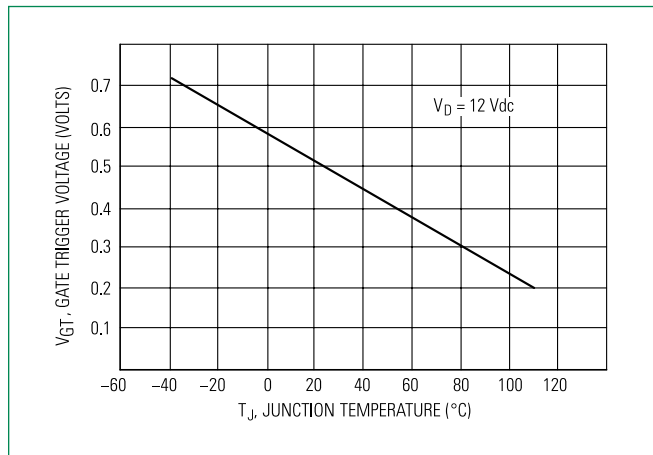

### Dimensions

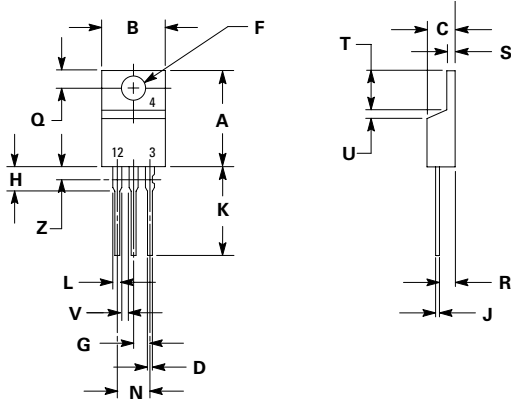

Dim	Inches		Millimeters	
	Min	Max	Min	Max
A	0.590	0.620	14.99	15.75
B	0.380	0.420	9.65	10.67
C	0.178	0.188	4.52	4.78
D	0.025	0.035	0.64	0.89
F	0.142	0.147	3.61	3.73
G	0.095	0.105	2.41	2.67
H	0.110	0.130	2.79	3.30
J	0.018	0.024	0.46	0.61
K	0.540	0.575	13.72	14.61
L	0.060	0.075	1.52	1.91
N	0.195	0.205	4.95	5.21
Q	0.105	0.115	2.67	2.92
R	0.085	0.095	2.16	2.41
S	0.045	0.060	1.14	1.52
T	0.235	0.255	5.97	6.47
U	0.000	0.050	0.00	1.27
V	0.045	---	1.15	---
Z	---	0.080	---	2.04

1. DIMENSIONING AND TOLERANCING PER ANSI Y14.5M, 1982.
2. CONTROLLING DIMENSION: INCH.
3. DIMENSION Z DEFINES A ZONE WHERE ALL BODY AND LEAD IRREGULARITIES ARE ALLOWED.

### Part Marking System

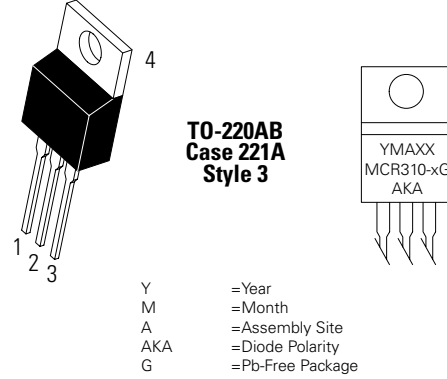

Pin Assignment	
1	Cathode
2	Anode
3	Gate
4	Anode

### Ordering Information

Device	Package	Shipping
MCR310-6	TO-220AB	500 Units / Box
MCR310-6G	TO-220AB (Pb-Free)	
MCR310-8	TO-220AB	
MCR310-8G	TO-220AB (Pb-Free)	
MCR310-10	TO-220AB	
MCR310-10G	TO-220AB (Pb-Free)	

**Disclaimer Notice** - Information furnished is believed to be accurate and reliable. However, users should independently evaluate the suitability of and test each product selected for their own applications. Littelfuse products are not designed for, and may not be used in, all applications. Read complete Disclaimer Notice at <http://www.littelfuse.com/disclaimer-electronics>.