

NYC0102BLT1G



Description

This NYC0102 SCR thyristor has been designed for low-power switching applications by implementing a sensitive gate triggered component.

Features

- High dv/dt noise immunity
- Gating Current < 200 μ A (micro amp)
- Miniature SOT-23 Package for High Density PCB
- RoHS compliant and Halogen Free/BFR free, Lead-Free

Functional Diagram

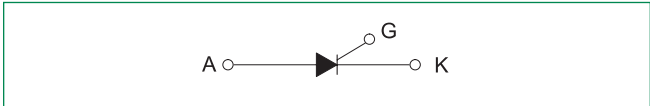

Pin Out

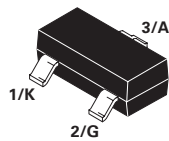

Additional Information



Resources



Accessories



Samples

Maximum Ratings ($T_J = 25^\circ\text{C}$ unless otherwise noted)

Rating	Symbol	Value	Unit
Peak Repetitive Off-State Voltage (Note 1) ($R_{GK} = I_{K'} T_J - 40$ to $+110^\circ\text{C}$, Sine Wave, 50 to 60 Hz)	V_{DRM} & V_{RRM}	200	V
On-State RMS Current (All Conduction Angles; $T_C = 80^\circ\text{C}$)	$I_T (RMS)$	0.25	A
Peak Non-Repetitive Surge Current (1/2 Cycle Sine Wave, 60 Hz, $T_A = 25^\circ\text{C}$)	I_{TSM}	7.0	A
Circuit Fusing Consideration ($t = 8.3$ ms)	I^2t	0.2	A ² sec
Forward Peak Gate Power (Pulse Width ≤ 1.0 sec, $T_A = 25^\circ\text{C}$)	P_{GM}	0.1	W
Forward Average Gate Power ($t = 8.3$ ms, $T_A = 25^\circ\text{C}$)	$P_{GM (AV)}$	0.02	W
Forward Peak Gate Current (Pulse Width ≤ 20 s, $T_A = 25^\circ\text{C}$)	I_{FGM}	0.5	A
Reverse Peak Gate Voltage (Pulse Width ≤ 1.0 s, $T_A = 25^\circ\text{C}$)	V_{RGM}	8.0	V
Operating Junction Temperature Range @ Rated V_{RRM} and V_{DRM}	T_J	-40 to +125	$^\circ\text{C}$
Storage Temperature Range	T_{stg}	-40 to +150	$^\circ\text{C}$

Thermal Characteristics

Rating	Symbol	Value	Unit
Total Component Dissipation FR-5 Board $T_A = 25^\circ\text{C}$	P_D	225	mW
Thermal Resistance, Junction-to-Ambient	$R_{\theta JA}$	380	$^\circ\text{C}/\text{W}$

Stresses exceeding Maximum Ratings may damage the component. Maximum Ratings are stress ratings only. Functional operation above the Recommended Operating Conditions is not implied. Extended exposure to stresses above the Recommended Operating Conditions may affect component reliability.

1. V_{DRM} and V_{RRM} for all types can be applied on a continuous basis. Ratings apply for zero or negative gate voltage; however, positive gate voltage shall not be applied concurrent with negative potential on the anode. Blocking voltages shall not be tested with a constant current source such that the voltage ratings of the components are exceeded.

Electrical Characteristics - OFF

Characteristic	Symbol	Min	Typ	Max	Unit
Peak Repetitive Forward Blocking Current (Note 3) ($V_{DRM} = 200\text{V}$, $R_{GK} = 1\text{k}\Omega$)	I_{DRM}	-	-	1.0 100	μA
Peak Repetitive Reverse Blocking Current ($V_{RRM} = 200\text{V}$, $R_{GK} = 1\text{k}\Omega$)	I_{RRM}	-	-	1.0 100	

Electrical Characteristics - ON ($T_J = 25^\circ\text{C}$ unless otherwise noted)

Characteristic	Symbol	Min	Typ	Max	Unit
Peak Forward On-State Voltage ($I_{TM} = 0.4$ A, $t_p < 1$ ms, $T_C = 25^\circ\text{C}$)	V_{TM}	-	-	1.7	V
Gate Trigger Current ($V_D = 12$ V, $R_L = 100$ Ω , $T_C = 25^\circ\text{C}$)	I_{GT}	-	-	200	μA
Gate Trigger Voltage ($V_D = 12$ V, $R_L = 100$ Ω , $T_C = 25^\circ\text{C}$)	V_{GT}	-	-	0.8	V
Holding Current ($I_T = 50$ mA, $R_{GK} = 1$ k Ω , $T_C = 25^\circ\text{C}$)	I_H	-	-	6.0	mA
Gate Non-Trigger Voltage ($V_D = V_{DRM}$, $R_L = 3.3$ k Ω , $T_C = 125^\circ\text{C}$)	V_{GD}	0.1	-	-	V
Latching Current ($I_G = 1.0$ mA, $R_{GK} = 1$ k Ω , $T_C = 25^\circ\text{C}$)	I_L	-	-	7.0	mA
Gate Reverse Voltage ($I_{RG} = 10$ μA)	V_{RG}	8.0	-	-	V

Dynamic Characteristics

Characteristic	Symbol	Min	Typ	Max	Unit
Critical Rate-of-Rise of Off State Voltage ($R_{GK} = 1$ k Ω , $T_C = 125^\circ\text{C}$)	dv/dt	200	-	-	V/ μs
Critical Rate of Rise of On-State Current ($I_G = 2 \times I_{GT}$, 60 Hz, $t_r < 100$ ns, $T_J = 125^\circ\text{C}$)	di/dt	-	-	50	A/ μs

Voltage/Current Characteristics of SCR

Symbol	Parameter
V_{DRM}	Peak Repetitive Forward Off State Voltage
I_{DRM}	Peak Forward Blocking Current
V_{RRM}	Peak Repetitive Reverse Off State Voltage
I_{RRM}	Peak Reverse Blocking Current
V_{TM}	Maximum On State Voltage
I_H	Holding Current

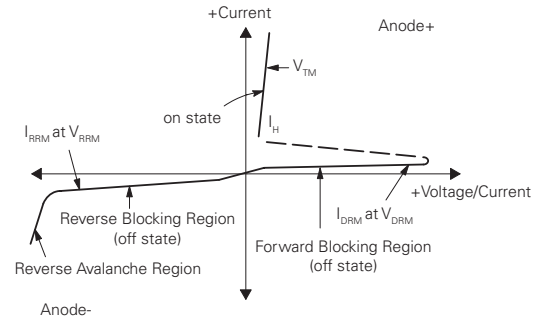

Figure 1. Maximum Average Power vs. Average Current

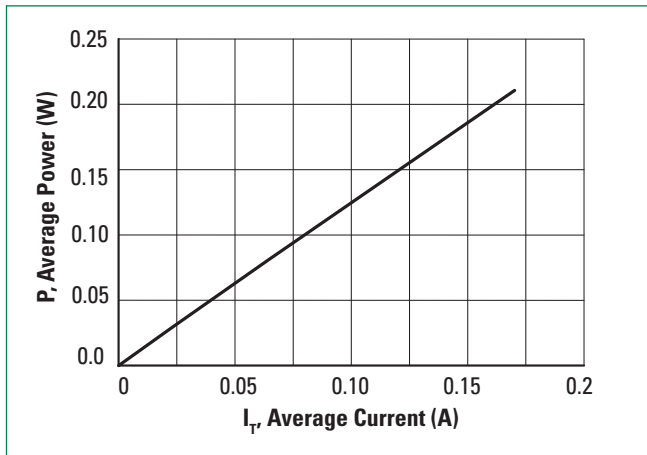

Figure 2. Current Derating

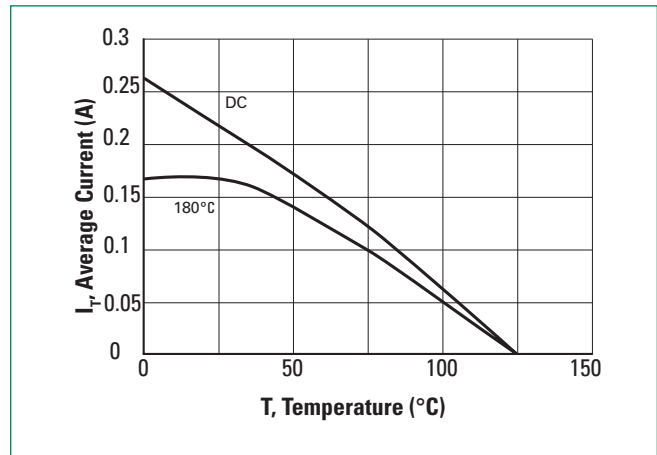

Figure 3. Surge Current I_{TSM} vs. Number of Cycles

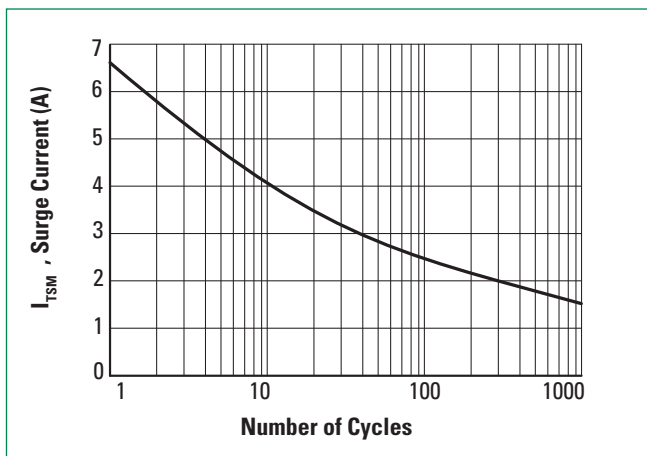

Figure 4. Thermal Response

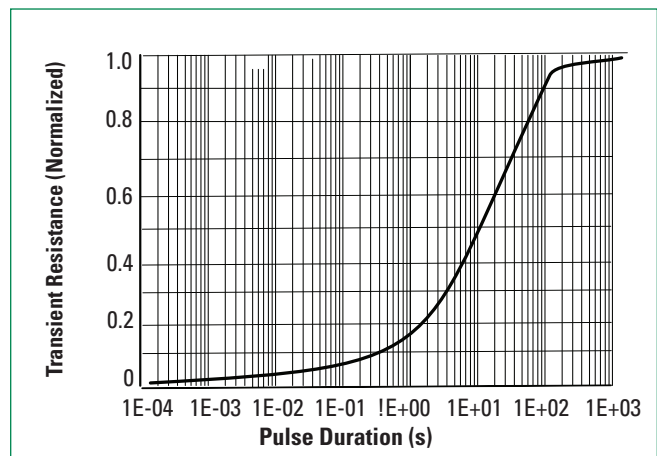

Figure 5. On-State Characteristics

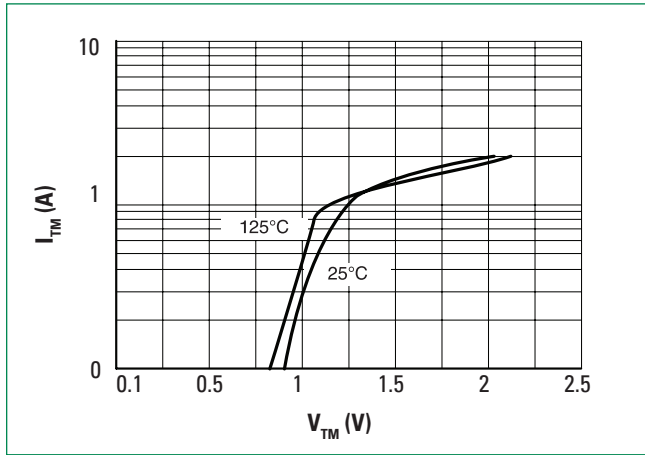

Figure 6. Gate Trigger Current vs. T_J (Normalized to 25 C)

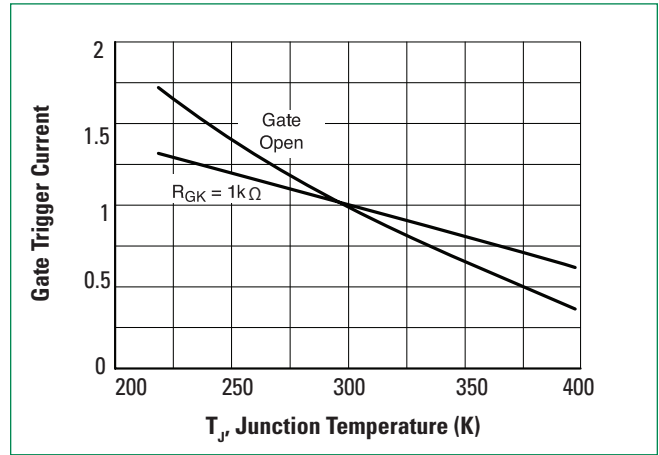

Figure 7. Gate Trigger Current vs. R_{GK}

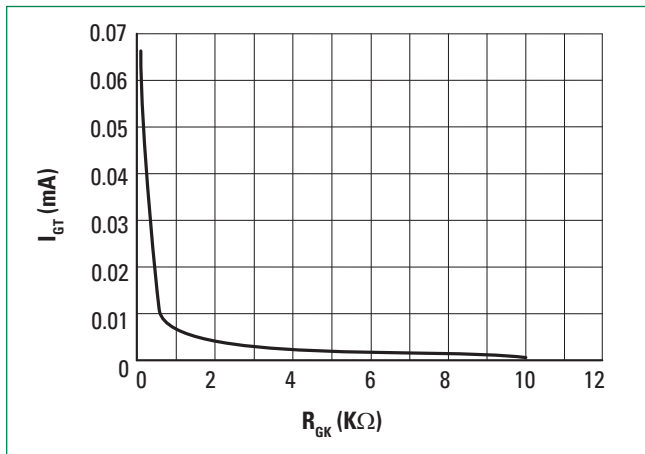

Figure 8. Holding and Latching Current vs. R_{GK}

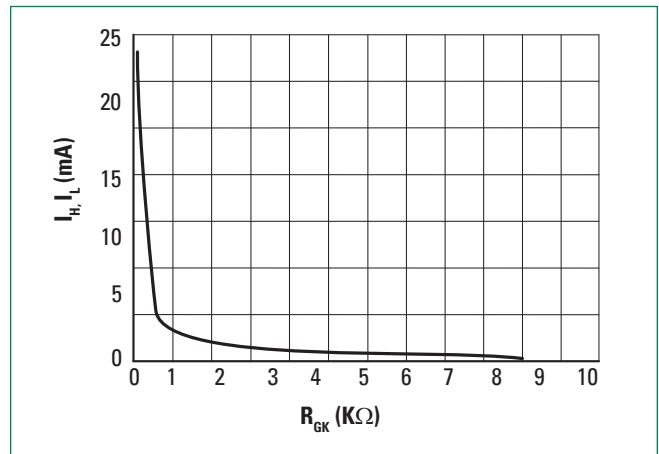

Figure 9. dV/dt vs. R_{GK}

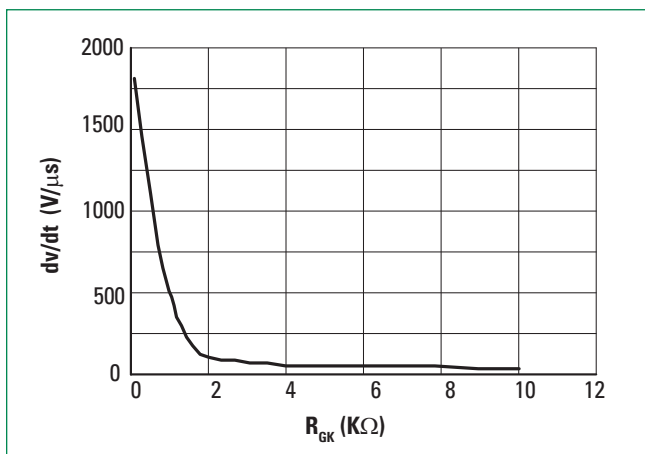
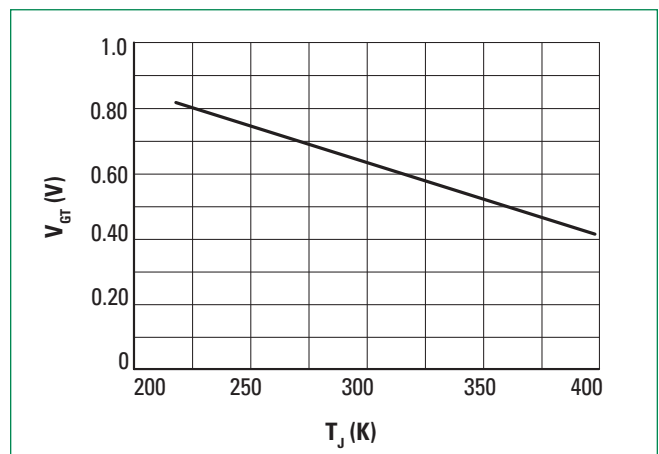
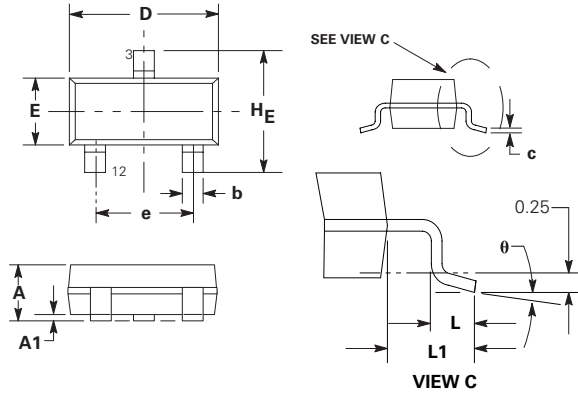

Figure 10. Gate Triggering Voltage vs. T_J



Dimensions



Dim	Inches			Millimeters		
	Min	Nom	Max	Min	Nom	Max
A	0.035	0.041	0.046	0.89	1.03	1.17
A1	0.004	0.004	0.006	0.01	0.10	0.15
b	0.012	0.016	0.020	0.30	0.40	0.50
c	0.003	0.006	0.008	0.08	0.14	0.20
D	0.110	0.114	0.120	2.80	2.90	3.04
E	0.047	0.051	0.055	1.20	1.30	1.40
e	---	0.075	---	---	1.90	---
L	0.016	0.019	0.024	0.40	0.49	0.60
L1	0.018	0.022	0.025	0.46	0.55	0.64
HE	0.083	0.091	0.104	2.10	2.30	2.64
ø	0°	---	10°	0°	---	10°

1. Diminishing and tolerancing per ANSI Y 14.5M, 1982.
2. Controlling Dimension: Inch
3. Maximum lead thickness includes lead finish thickness. Minimum lead thickness is the minimum thickness of base material.
4. Dimensions D and E do not include mold flash, protrusions, or gate burrs.

Soldering Footprint

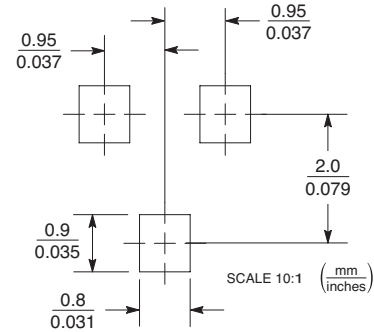

Part Marking System

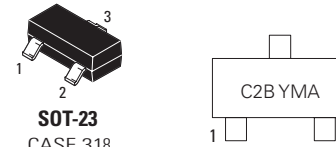

SOT-23
CASE 318
STYLE 8
C2B= Specific Device Code
YMA= Date Code*
▪ Pb-Free Package

(Note: Microdot may be in either location)

*Date Code orientation and/or overbar may vary depending upon manufacturing location.

Pin Assignment

Pin	Assignment
1	Cathode
2	Gate
3	Anode

Ordering Information

Device	Package	Shipping
NYC0102BLT1G	SOT-23 (Pb-Free)	3000/Tape & Reel/Box

Disclaimer Notice - Information furnished is believed to be accurate and reliable. However, users should independently evaluate the suitability of and test each product selected for their own applications. Littelfuse products are not designed for, and may not be used in, all applications. Read complete Disclaimer Notice at: www.littelfuse.com/disclaimer-electronics