

Qxx25xx & Qxx25xHx Series

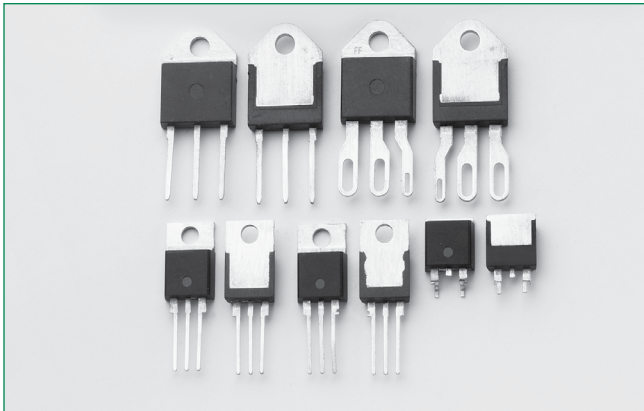

Agency Approval

Agency	Agency File Number
	E71639*

* - Only Package Types TO-220L, TO-218K and TO-218J

Main Features

Symbol	Value	Unit
$I_{T(RMS)}$	25	A
V_{DRM}/V_{RRM}	1000	V
I_{GT}	50 or 80	mA

Schematic Symbol

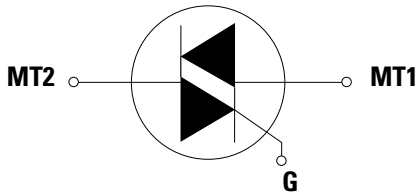

Description

This 25 Amp bi-directional solid state switch series is designed for AC switching and phase control applications such as motor speed and temperature modulation controls, lighting controls, and static switching relays.

Standard alternistor triac components operate with in-phase signals in Quadrants I or III and ONLY unipolar negative gate pulses for Quadrant II or III. The alternistor triac will not operate in Quadrant IV.

Features & Benefits

- RoHS compliant
- Glass – passivated junctions
- Voltage capability up to 1000 V
- Surge capability up to 250A at 60 Hz half cycle

Applications

Excellent for AC switching and phase control applications such as heating, lighting, and motor speed controls.

Typical applications are AC solid-state switches, industrial power tools, exercise equipment, white goods and commercial appliances.

Alternistor Triacs (no snubber required) are used in applications with high inductive loads requiring the highest commutation performance.

Internally constructed isolated packages are offered for ease of heat sinking with highest isolation voltage.

Additional Information



Absolute Maximum Ratings – Standard Triac

Symbol	Parameter	Test Conditions	Value	Unit
$I_{T(RMS)}$	RMS on-state current	Qxx25R5 Qxx25N5 Qxx25L5 $T_c = 65^\circ\text{C}$ $T_c = 95^\circ\text{C}$	25	A
I_{TSM}	Peak non-repetitive surge current	Qxx25R5 Qxx25N5 Qxx25L5 full cycle; f = 50Hz; T_J (initial) = 25°C	167	A
		full cycle; f = 60Hz; T_J (initial) = 25°C	200	
I^2t	I^2t Value for fusing	Qxx25R5 Qxx25N5 Qxx25L5 $t_p = 8.3\text{ms}$	166	A ² s
di/dt	Critical rate-of-rise of on-state current	f = 60Hz; $T_J = 125^\circ\text{C}$	100	A/ μs
I_{GTM}	Peak gate current	$t_p = 20\mu\text{s}$, $T_J = 125^\circ\text{C}$	4	A
$P_{G(AV)}$	Average gate power dissipation	$T_J = 125^\circ\text{C}$	0.5	W
T_{stg}	Storage temperature range		-40 to 125	°C
T_J	Operating junction temperature range	Qxx25R5 Qxx25N5 Qxx25L5	-40 to 125	°C

Absolute Maximum Ratings – Alternistor Triac

Symbol	Parameter	Test Conditions	Value	Unit
$I_{T(RMS)}$	RMS on-state current	Qxx25LH5 Qxx25L6 $T_c = 65^\circ\text{C}$	25	A
		Qxx25K6 Qxx25J6 $T_c = 85^\circ\text{C}$		
		Qxx25RH5 Qxx25NH5 Qxx25R6 Qxx25NH6 $T_c = 95^\circ\text{C}$		
I_{TSM}	Peak non-repetitive surge current	full cycle; f = 50Hz; T_J (initial) = 25°C	208	A
		full cycle; f = 60Hz; T_J (initial) = 25°C	250	
I^2t	I^2t Value for fusing	$t_p = 8.3\text{ms}$	260	A ² s
di/dt	Critical rate-of-rise of on-state current	f = 60Hz; $T_J = 125^\circ\text{C}$	100	A/ μs
I_{GTM}	Peak gate current	$t_p = 20\mu\text{s}$, $T_J = 125^\circ\text{C}$	4	A
$P_{G(AV)}$	Average gate power dissipation	$T_J = 125^\circ\text{C}$	0.5	W
T_{stg}	Storage temperature range		-40 to 125	°C
T_J	Operating junction temperature range		-40 to 125	°C

Note: xx = voltage/10

Electrical Characteristics ($T_J = 25^\circ\text{C}$, unless otherwise specified) — Standard Triac

Symbol	Test Conditions	Quadrant		Value		Unit
				Qxx25R5 Qxx25N5 Qxx25L5		
I_{GT}	$V_D = 12\text{V}; R_L = 60\ \Omega$	I – II – III IV	MAX. TYP.	50 120		mA
V_{GT}	$V_D = 12\text{V}; R_L = 60\ \Omega$	I – II – III IV	MAX. TYP.	1.3 2.5		V
V_{GD}	$V_D = V_{DRM}; R_L = 3.3\ \text{k}\Omega; T_J = 125^\circ\text{C}$	ALL	MIN.	0.2		V
I_H	$I_T = 400\text{mA}$ (initial)		MAX.	100		mA
dv/dt	$V_D = V_{DRM};$ Gate Open; $T_J = 125^\circ\text{C}$	400V	MIN.	275		V/ μs
		600V		225		
		800V		200		
		1000V		200		
$(dv/dt)c$	$(di/dt)c = 13.3\ \text{A/ms}; T_J = 125^\circ\text{C}$		MIN.	5		V/ μs
			TYP.	4		μs
t_{gt}	$I_G = 2 \times I_{GT}; PW = 15\ \mu\text{s}; I_T = 35.4\ \text{A}$		TYP.	4		μs

Electrical Characteristics ($T_J = 25^\circ\text{C}$, unless otherwise specified) — Alternistor Triac

Symbol	Test Conditions	Quadrant		Value		Unit
				Qxx25RH5 Qxx25LH5 Qxx25NH5	Qxx25R6 Qxx25L6 Qxx25NH6 Qxx25K6 Qxx25J6	
I_{GT}	$V_D = 12\text{V}; R_L = 60\ \Omega$	I – II – III	MAX.	50	80	mA
V_{GT}	$V_D = 12\text{V}; R_L = 60\ \Omega$	I – II – III	MAX.	1.3		V
V_{GD}	$V_D = V_{DRM}; R_L = 3.3\ \text{k}\Omega; T_J = 125^\circ\text{C}$	I – II – III	MIN.	0.2		V
I_H	$I_T = 400\text{mA}$ (initial)		MAX.	50	100	mA
dv/dt	$V_D = V_{DRM};$ Gate Open; $T_J = 125^\circ\text{C}$	400V	MIN.	575	600	V/ μs
		600V		500	600	
		800V		400	475	
		1000V		-	400	
$(dv/dt)c$	$(di/dt)c = 13.3\ \text{A/ms}; T_J = 125^\circ\text{C}$		MIN.	20	30	V/ μs
			TYP.	3	5	μs
t_{gt}	$I_G = 2 \times I_{GT}; PW = 15\ \mu\text{s}; I_T = 35.4\ \text{A}$		TYP.	3	5	μs

Static Characteristics

Symbol	Test Conditions		Quadrant		Value		Unit
					Qxx25R5 Qxx25N5 Qxx25xH5 Qxx25x6 Qxx25NH6 Qxx25L5		
V_{TM}	$I_T = 35.4\text{A}; t_p = 380\ \mu\text{s}$			MAX.	1.8		V
I_{DRM} / I_{RRM}	V_{DRM} / V_{RRM}	$T_J = 25^\circ\text{C}$	400 - 800V	MAX.	10		μA
			1000V		20		
		$T_J = 100^\circ\text{C}$	400 - 800V		500		
			1000V		1000		
$T_J = 125^\circ\text{C}$	400 - 800V	2000					

Note: xx = voltage/10, x = package

Thermal Resistances

Symbol	Parameter	Value	Unit	
$R_{\theta(J-C)}$	Junction to case (AC)	Qxx25R5 / Qxx25N5 Qxx25R6 / Qxx25NH6 Qxx25RH5 / Qxx25NH5	0.89	°C/W
		Qxx25L6 / Qxx25LH5 / Qxx25L5	2.0	
		Qxx25K6 / Qxx25J6	1.32	
$R_{\theta(J-A)}$	Junction to ambient	Qxx25Ry	45	°C/W
		Qxx25L6 / Qxx25LH5 / Qxx25L5	50	

Note: xx = voltage/10, y = sensitivity

Figure 1: Normalized DC Gate Trigger Current vs. Junction Temperature

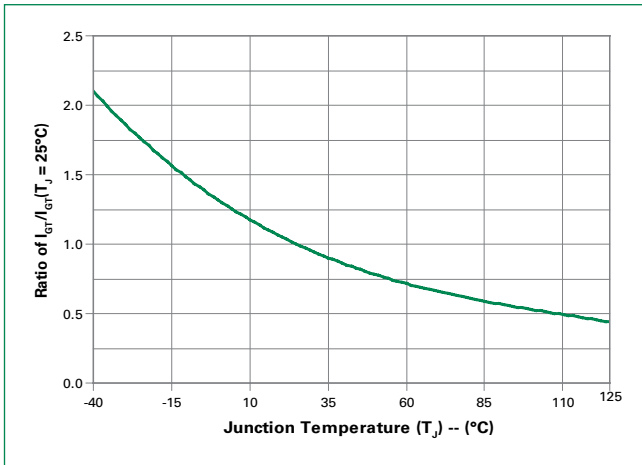

Figure 2: Normalized DC Gate Trigger Voltage vs. Junction Temperature

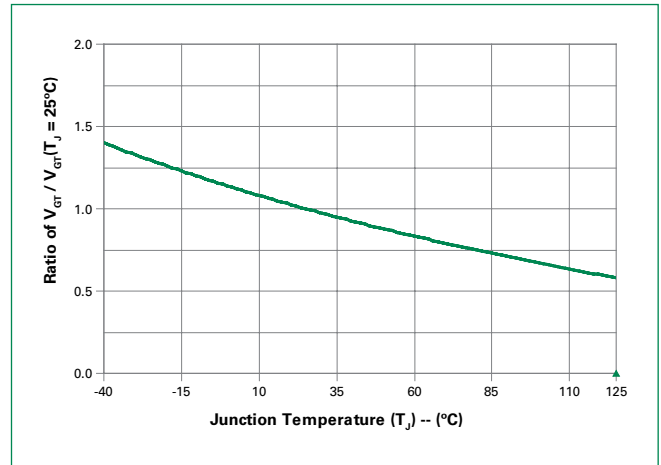

Figure 3: Normalized DC Holding Current vs. Junction Temperature

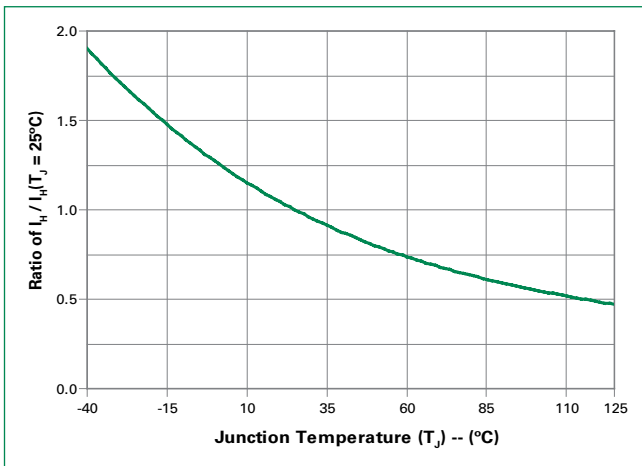

Figure 4: On-State Current vs. On-State Voltage (Typical)

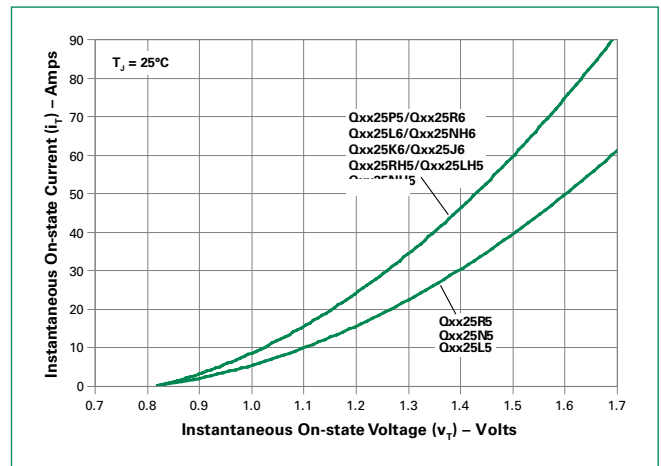

Figure 5: Power Dissipation (Typical) vs. RMS On-State Current

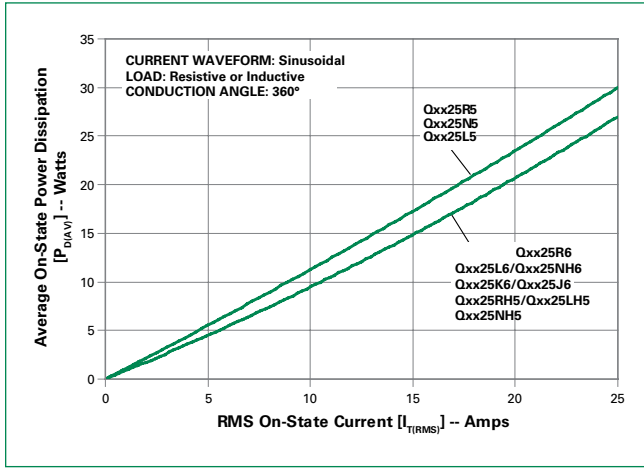

Figure 6: Maximum Allowable Case Temperature vs. RMS On-State Current

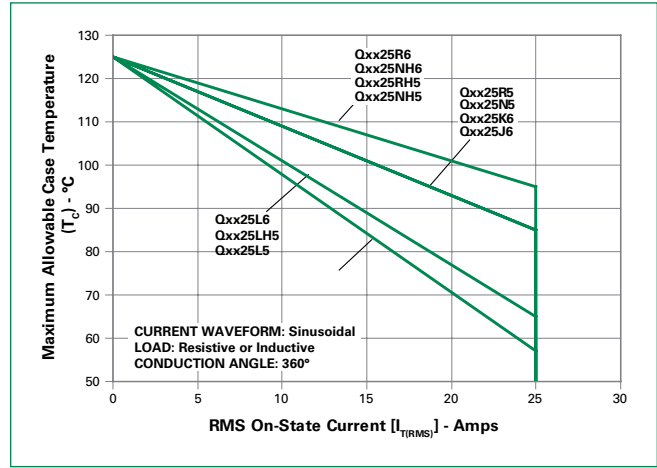

Figure 7: Maximum Allowable Ambient Temperature vs. RMS On-State Current (TO-220 packages only)

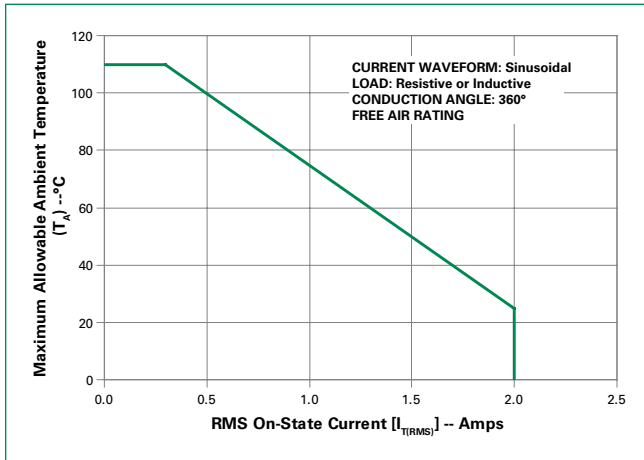
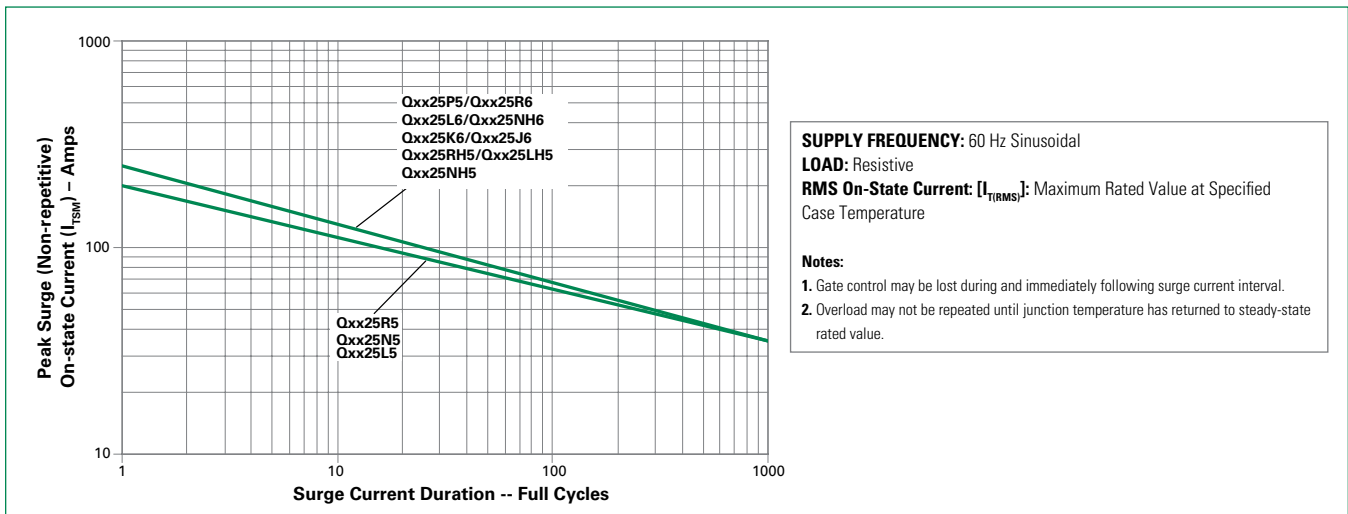
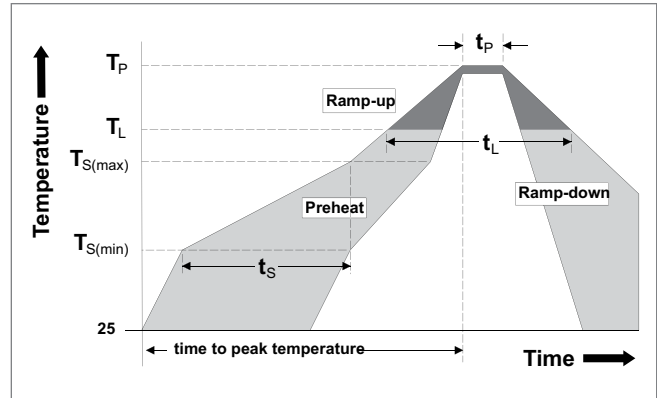

Figure 8: Surge Peak On-State Current vs. Number of Cycles



Soldering Parameters

Reflow Condition		Pb – Free assembly
Pre Heat	- Temperature Min ($T_{s(min)}$)	150°C
	- Temperature Max ($T_{s(max)}$)	200°C
	- Time (min to max) (t_s)	60 – 180 secs
Average ramp up rate (Liquidus Temp) (T_L) to peak		5°C/second max
$T_{s(max)}$ to T_L - Ramp-up Rate		5°C/second max
Reflow	- Temperature (T_L) (Liquidus)	217°C
	- Temperature (t_L)	60 – 150 seconds
Peak Temperature (T_p)		260 ^{+0/-5} °C
Time within 5°C of actual peak Temperature (t_p)		20 – 40 seconds
Ramp-down Rate		5°C/second max
Time 25°C to peak Temperature (T_p)		8 minutes Max.
Do not exceed		280°C



Physical Specifications

Terminal Finish	100% Matte Tin-plated
Body Material	UL Recognized compound meeting flammability rating V-0
Lead Material	Copper Alloy

Design Considerations

Careful selection of the correct component for the application's operating parameters and environment will go a long way toward extending the operating life of the Thyristor. Good design practice should limit the maximum continuous current through the main terminals to 75% of the device rating. Other ways to ensure long life for a power discrete semiconductor are proper heat sinking and selection of voltage ratings for worst case conditions. Overheating, overvoltage (including dv/dt), and surge currents are the main killers of semiconductors. Correct mounting, soldering, and forming of the leads also help protect against component damage.

Environmental Specifications

Test	Specifications and Conditions
High Temperature Voltage Blocking	MIL-STD-750: Method 1040, Condition A Rated V_{RRM} , 125°C, 1008 hours
Temperature Cycling	MIL-STD-750: Method 1051 -40°C to 125°C, 15-minute dwell, 100 cycles
Biased Temp & Humidity	EIA/JEDEC: JESD22-A101 320VDC, 85°C, 85%RH, 1008 hours
High Temp. Storage	MIL-STD-750: Method 1031 150°C, 1008 hours
Low-Temp Storage	-40°C, 1008 hours
Resistance to Solder Heat	MIL-STD-750: Method 2031 260°C, 10 seconds
Solderability	ANSI/J-STD-002, Category 3, Test A
Lead Bend	MIL-STD-750: Method 2036, Condition E

Dimensions — TO-220AB (R Package) — Non-isolated Mounting Tab

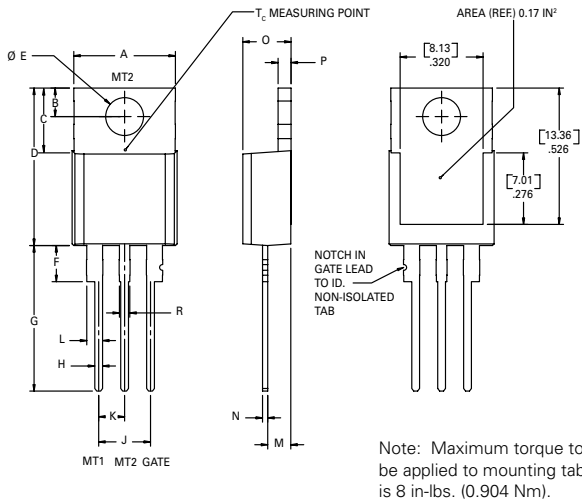

Dimension	Inches		Millimeters	
	Min	Max	Min	Max
A	0.380	0.420	9.65	10.67
B	0.105	0.115	2.67	2.92
C	0.230	0.250	5.84	6.35
D	0.590	0.620	14.99	15.75
E	0.142	0.147	3.61	3.73
F	0.110	0.130	2.79	3.30
G	0.540	0.575	13.72	14.61
H	0.025	0.035	0.64	0.89
J	0.195	0.205	4.95	5.21
K	0.095	0.105	2.41	2.67
L	0.060	0.075	1.52	1.91
M	0.085	0.095	2.16	2.41
N	0.018	0.024	0.46	0.61
O	0.178	0.188	4.52	4.78
P	0.045	0.060	1.14	1.52
R	0.038	0.048	0.97	1.22

Dimensions — TO-220AB (L Package) — Isolated Mounting Tab

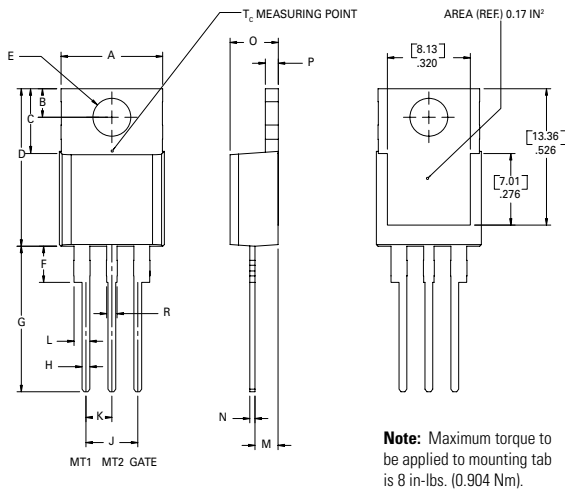

Dimension	Inches		Millimeters	
	Min	Max	Min	Max
A	0.380	0.420	9.65	10.67
B	0.105	0.115	2.66	2.92
C	0.230	0.250	5.85	6.35
D	0.590	0.620	14.98	15.75
E	0.142	0.147	3.61	3.73
F	0.110	0.130	2.80	3.30
G	0.540	0.575	13.71	14.60
H	0.025	0.035	0.63	0.89
J	0.195	0.205	4.95	5.21
K	0.095	0.105	2.41	2.67
L	0.060	0.075	1.52	1.91
M	0.085	0.095	1.78	2.16
N	0.018	0.024	0.45	0.61
O	0.178	0.188	4.52	4.78
P	0.045	0.060	1.14	1.53
R	0.038	0.048	0.97	1.22

Dimensions — TO-218X (J Package) — Isolated Mounting Tab

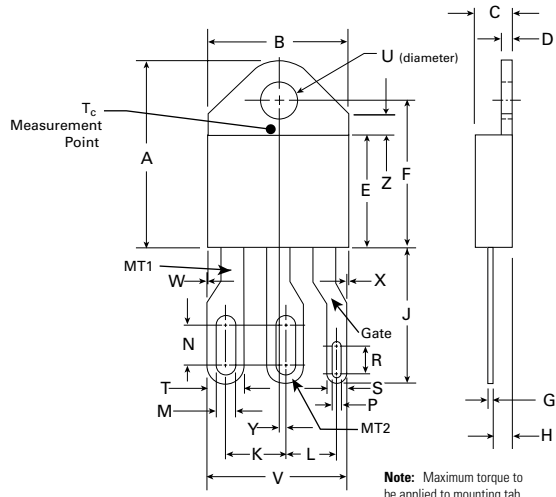

Note: Maximum torque to be applied to mounting tab is 8 in-lbs. (0.904 Nm).

Dimension	Inches		Millimeters	
	Min	Max	Min	Max
A	0.810	0.835	20.57	21.21
B	0.610	0.630	15.49	16.00
C	0.178	0.188	4.52	4.78
D	0.055	0.070	1.40	1.78
E	0.487	0.497	12.37	12.62
F	0.635	0.655	16.13	16.64
G	0.022	0.029	0.56	0.74
H	0.075	0.095	1.91	2.41
J	0.575	0.625	14.61	15.88
K	0.256	0.264	6.50	6.71
L	0.220	0.228	5.58	5.79
M	0.080	0.088	2.03	2.24
N	0.169	0.177	4.29	4.49
P	0.034	0.042	0.86	1.07
R	0.113	0.121	2.87	3.07
S	0.086	0.096	2.18	2.44
T	0.156	0.166	3.96	4.22
U	0.164	0.165	0.410	0.420
V	0.603	0.618	15.31	15.70
W	0.000	0.005	0.00	0.13
X	0.003	0.012	0.07	0.30
Y	0.028	0.032	0.71	0.81
Z	0.085	0.095	2.17	2.42

Product Selector

Part Number	Voltage				Gate Sensitivity Quadrants		Package
	400V	600V	800V	1000V	I - II - III	IV	
Qxx25R5	X	X	X	X	50 mA	120 mA (TYP)	TO-220R
Qxx25N5	X	X	X	X	50 mA	120 mA (TYP)	TO-263 D ² -Pak
Qxx25L5	X	X	X	X	50 mA	120 mA (YTP)	TO-220L
Qxx25RH5 ¹	X	X	X	-	50 mA	-	TO-220R
Qxx25LH5	X	X	X	-	50 mA	-	TO-220L
Qxx25NH5	X	X	X	-	50 mA	-	TO-263 D ² -Pak
Qxx25R6	X	X	X	X	80 mA	-	TO-220R
Qxx25L6	X	X	X	X	80 mA	-	TO-220L
Qxx25NH6	X	X	X	X	80 mA	-	TO-263 D ² -Pak
Qxx25J6	X	X	X	-	80 mA	-	TO-218X
Qxx25K6	X	X	X	X	80 mA	-	TO-218AC

Packing Options

Part Number	Marking	Weight	Packing Mode	Base Quantity
Qxx25R5TP	Qxx25R5	2.20g	Tube	1000 (50 per tube)
Qxx25N5TP	Qxx25N5	1.60g	Tube	1000 (50 per tube)
Qxx25N5RP	Qxx25N5	1.60g	Embossed Carrier	500
Qxx25RH5TP	Qxx25RH5	2.20g	Tube	1000 (50 per tube)
Qxx25LH5TP	Qxx25LH5	2.20g	Tube	1000 (50 per tube)
Qxx25NH5TP	Qxx25NH5	1.60g	Tube	1000 (50 per tube)
Qxx25NH5RP	Qxx25NH5	1.60g	Embossed Carrier	500
Qxx25R6TP	Qxx25R6	2.20g	Tube	1000 (50 per tube)
Qxx25L6TP	Qxx25L6	2.20g	Tube	1000 (50 per tube)
Qxx25NH6TP	Qxx25NH6	1.60g	Tube	1000 (50 per tube)
Qxx25NH6RP	Qxx25NH6	1.60g	Embossed Carrier	500
Qxx25J6TP	Qxx25J6	5.23g	Tube	250 (25 per tube)
Qxx25K6TP	Qxx25K6	4.40g	Tube	250 (25 per tube)
Qxx25L5TP	Qxx25L5	2.20g	Tube	1000 (50 per tube)

TO-263 Embossed Carrier Reel Pack (RP) Specifications

Meets all EIA-481-2 Standards

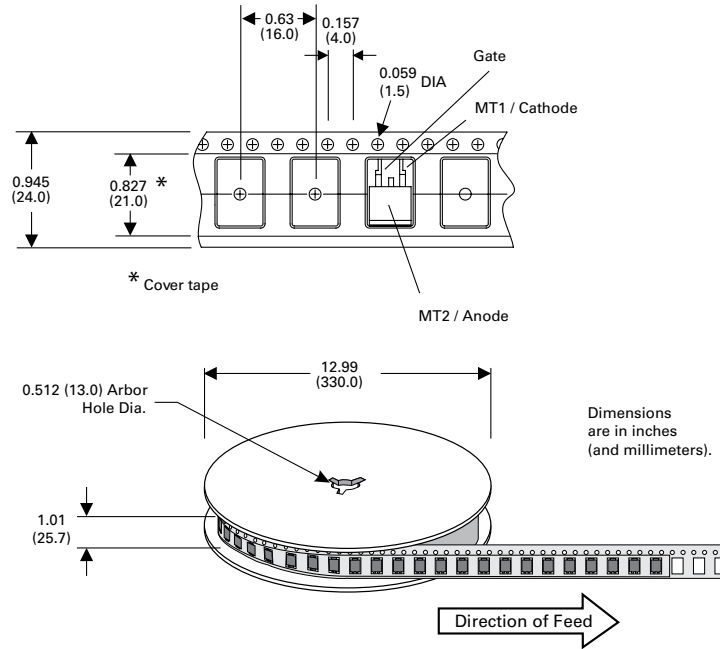

Part Numbering System

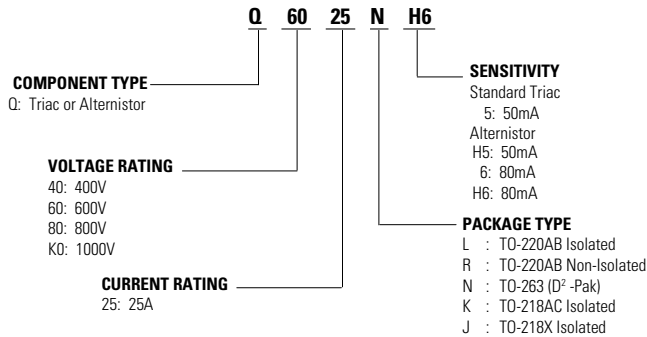

Part Marking System

TO-220 AB - (L and R Package)
TO-263 AB - (N Package)



TO-218AC - (K Package)
TO-218X - (J Package)

