

SK225xD Series

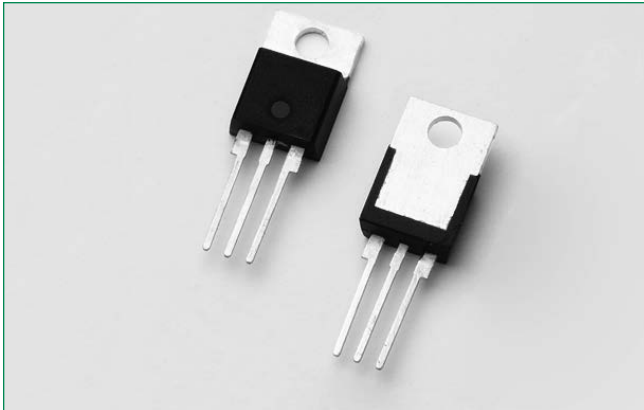

Description

Excellent unidirectional switches for phase control applications such as heating and motor speed controls. Standard phase control SCRs are triggered with few milliamperes of current at less than 1.5V potential.

Features & Benefits

- RoHS compliant
- Voltage capability up to 1200 V
- Surge capability up to 300 A
- Electrically isolated package "LD-Package" and UL Recognized for 2500V_{RMS}

Agency Recognitions

Agency	Agency File Number
	E71639

Applications

Typical applications are AC solid-state switches, industrial power tools, line rectification 50/60Hz.

Internally constructed isolated packages are offered for ease of heat sinking with highest isolation voltage.

Main Features

Symbol	Value	Unit
$I_{T(RMS)}$	25	A
V_{DRM}/V_{RRM}	1200	V
I_{GT}	40	mA

Schematic Symbol

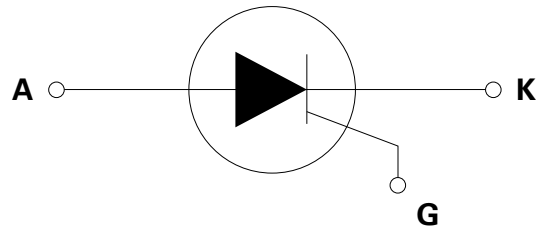

Absolute Maximum Ratings — 25A SCR

Symbol	Parameter	Test Conditions		Value	Unit
V_{DRM}/V_{RRM}	Repetitive Peak off-state/Reverse Voltage			1200	V
V_{DSM}/V_{RSM}	Non-repetitive peak off-state/Reverse voltage			1300	V
$I_{T(RMS)}$	RMS on-state current	SK225LD	$T_c=75^\circ\text{C}$	25	A
		SK225RD	$T_c=95^\circ\text{C}$		
$I_{T(AV)}$	Average on-state current	SK225LD	$T_c=75^\circ\text{C}$	16	A
		SK225RD	$T_c=95^\circ\text{C}$		
I_{TSM}	Peak non-repetitive surge current	single half cycle; $f = 50\text{Hz}$; $T_J(\text{initial}) = 25^\circ\text{C}$		300	A
		single half cycle; $f = 60\text{Hz}$; $T_J(\text{initial}) = 25^\circ\text{C}$		360	
I^2t	I^2t Value for fusing	$t_p = 8.3 \text{ ms}$		540	A^2s
di/dt	Critical rate of rise of on-state current			50	$\text{A}/\mu\text{s}$
I_{GM}	Peak gate current	$T_J = 125^\circ\text{C}$		3	A
$P_{G(AV)}$	Average gate power dissipation	$T_J = 125^\circ\text{C}$		1	W
T_{stg}	Storage temperature range			-40 to 150	$^\circ\text{C}$
T_J	Operating junction temperature range			-40 to 125	$^\circ\text{C}$

Notes :
x = package

Electrical Characteristics ($T_J = 25^\circ\text{C}$, unless otherwise specified)

Symbol	Test Conditions	Value	Unit
I_{GT}	$V_D = 12\text{V}; R_L = 30\Omega$	MAX.	40
V_{GT}		MAX.	1.5
dv/dt	$V_D = 2/3 V_{DRM}$; gate open; $T_J = 125^\circ\text{C}$	MIN.	1000
V_{GD}	$V_D = V_{DRM}$; $R_L = 3.3 \text{ k}\Omega$; $T_J = 125^\circ\text{C}$	MIN.	0.2
I_H	$I_T = 500\text{mA}$ (initial)	MAX.	100
t_q	$I_T=0.5\text{A}$; $t_p=50\mu\text{s}$; $dv/dt=5\text{V}/\mu\text{s}$; $di/dt=-30\text{A}/\mu\text{s}$	TYP.	15
t_{gt}	$I_G = 2 \times I_{GT}$; $PW = 15\mu\text{s}$; $I_T = 50\text{A}$	TYP.	3

Notes :
x = package

Static Characteristics

Symbol	Test Conditions	Value	Unit	
V_{TM}	$I_T = 50\text{A}$; $t_p = 380\mu\text{s}$	MAX.	1.6	
I_{DRM}/I_{RRM}	V_{DRM}/V_{RRM}	$T_J = 25^\circ\text{C}$	MAX.	10
		$T_J = 125^\circ\text{C}$	MAX.	4

Thermal Resistances

Symbol	Parameter	Value	Unit
$R_{\theta(JC)}$	Junction to case (AC)	SK225RD	1.0
		SK225LD	1.9

Figure 1: Normalized DC Gate Trigger Current vs. Junction Temperature

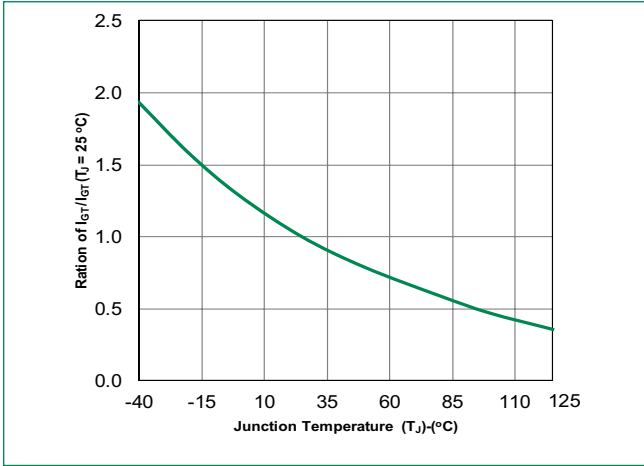

Figure 2: Normalized DC Gate Trigger Voltage vs. Junction Temperature

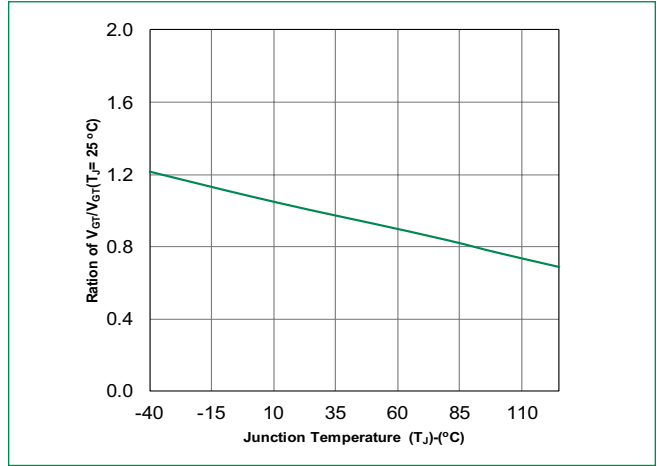

Figure 3: Normalized DC Holding Current vs. Junction Temperature

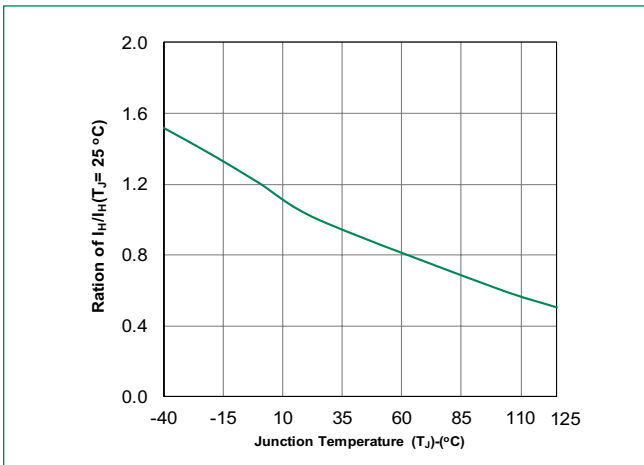

Figure 4: On-State Current vs. On-State Voltage (Typical)

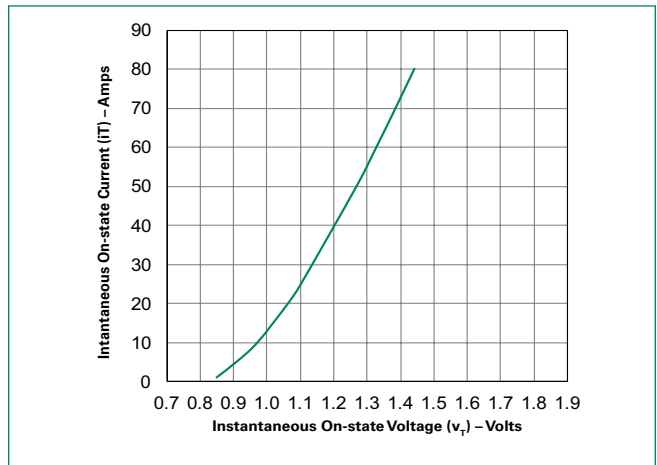

Figure 5: Power Dissipation (Typical) vs. RMS On-State Current

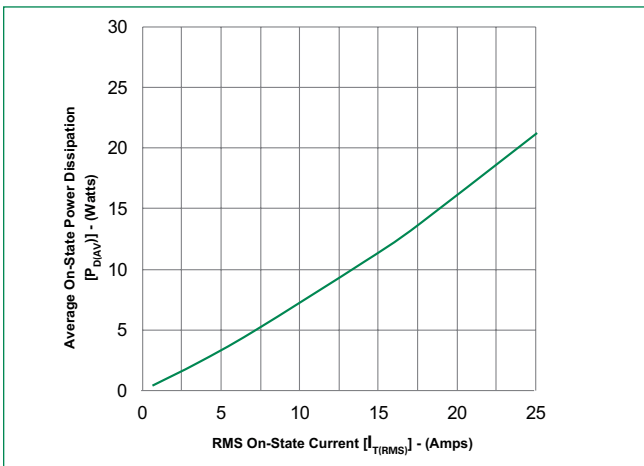

Figure 6: Maximum Allowable Case Temperature vs. RMS On-State Current

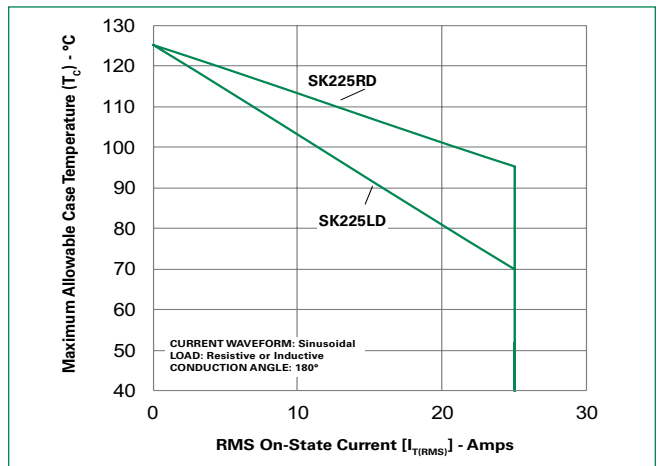

Figure 7: Maximum Allowable Case Temperature vs. Average On-State Current

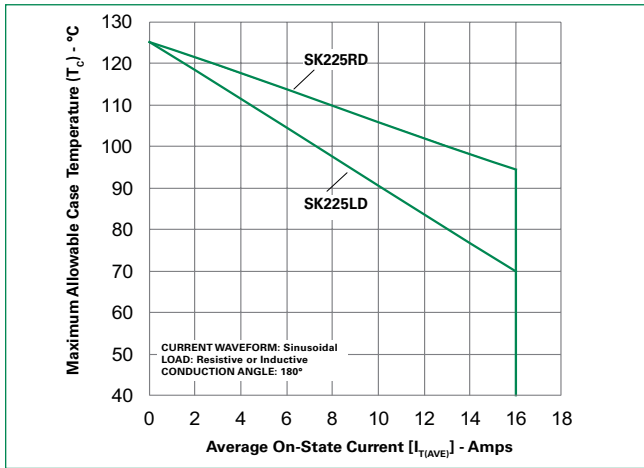
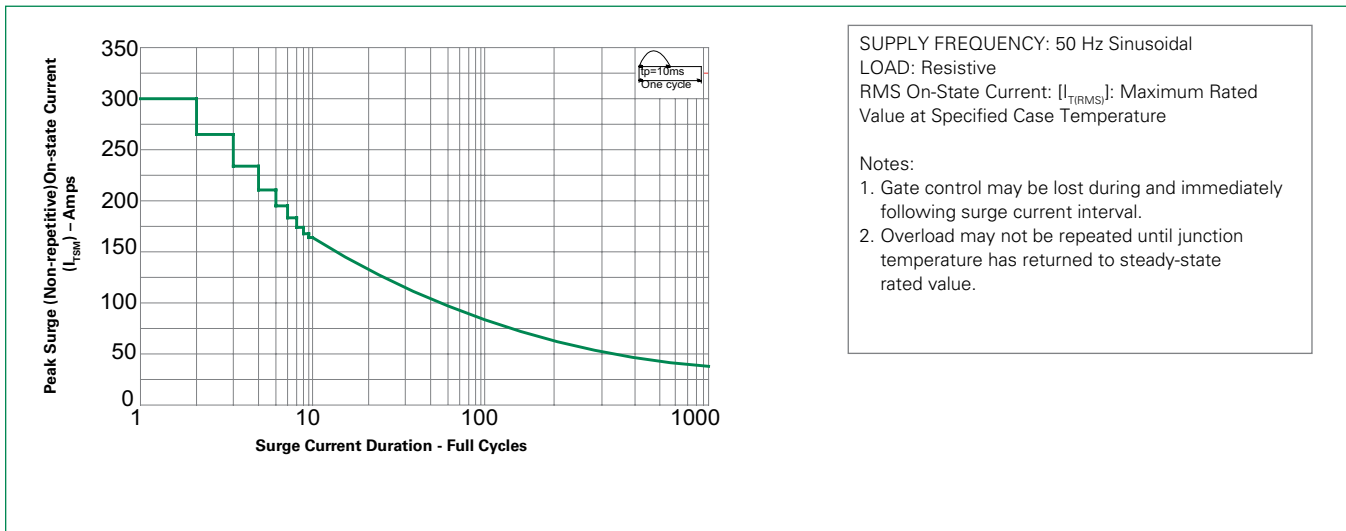

Figure 8: Surge Peak On-State Current vs. Number of Cycles



Environmental Specifications

Test	Specifications and Conditions
AC Blocking	JESD22-A108C, 80% V _{DRM} @125°C for 168 hours
Temperature Cycling	MIL-STD-750, M-1051, 100 cycles; -40°C to +150°C; 15-min dwell-time
Temperature/Humidity	EIA / JEDEC, JESD22-A101 168 hours; 100V - DC: 85°C; 85% rel humidity
Resistance to Solder Heat	JESD22-B106C
Solderability	J-STD-022, category 3, test A

Physical Specification

Terminal Finish	100% Matte Tin-Plated
Body Material	UL Recognized compound meeting flammability rating V-0

Design Considerations

Careful selection of the correct component for the application's operating parameters and environment will go a long way toward extending the operating life of the Thyristor. Good design practice should limit the maximum continuous current through the main terminals to 75% of the component rating. Other ways to ensure long life for a power discrete semiconductor are proper heat sinking and selection of voltage ratings for worst case conditions. Overheating, overvoltage (including dv/dt), and surge currents are the main killers of semiconductors. Correct mounting, soldering, and forming of the leads also help protect against component damage.

Dimensions — TO-220AB (RD-Package) — Non-Isolated Mounting Tab Common with Center Lead

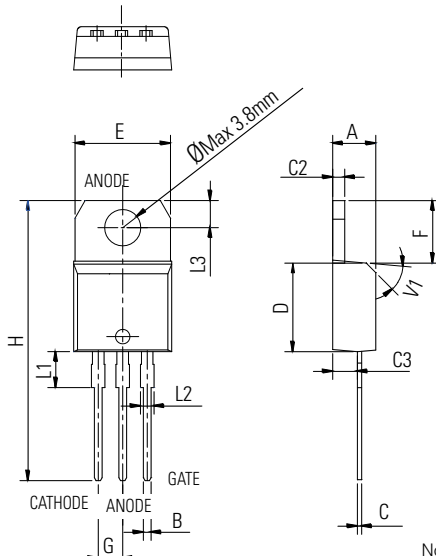

Note: Maximum torque to be applied to mounting tab is 3 in-lbs (0.3Nm).

Dimension	Millimeters			Inches		
	Min.	Typ.	Max.	Min.	Typ.	Max.
A	4.40		4.60	0.173		0.181
B	0.61		0.88	0.024		0.035
C	0.46		0.70	0.018		0.028
C2	1.21		1.32	0.048		0.052
C3	2.40		2.72	0.094		0.107
D	8.60		9.70	0.339		0.382
E	9.60		10.4	0.378		0.409
F	6.20		6.60	0.244		0.260
G		2.54			0.1	
H	28.0		29.8	1.102		1.173
L1		3.75			0.148	
L2	1.14		1.70	0.045		0.067
L3	2.65		2.95	0.104		0.116
V1		45°			45°	

Dimensions — TO-220AB (LD-Package) — Isolated Mounting Tab

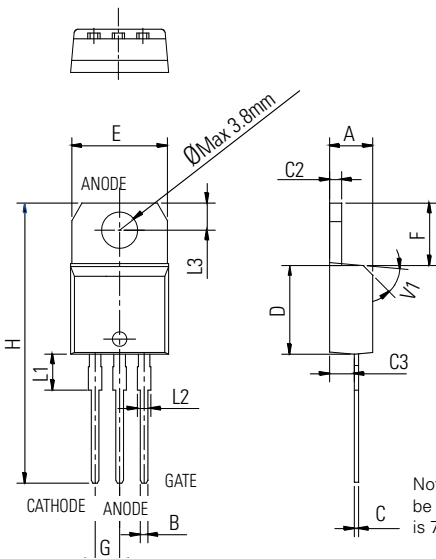

Note: Maximum torque to be applied to mounting tab is 7 in-lbs. (0.8 Nm).

Dimension	Millimeters			Inches		
	Min.	Typ.	Max.	Min.	Typ.	Max.
A	4.40		4.60	0.173		0.181
B	0.61		0.88	0.024		0.035
C	0.46		0.70	0.018		0.028
C2	1.21		1.32	0.048		0.052
C3	2.40		2.72	0.094		0.107
D	8.60		9.70	0.339		0.382
E	9.80		10.4	0.386		0.409
F	6.55		6.95	0.258		0.274
G		2.54			0.1	
H	28.0		29.8	1.102		1.173
L1		3.75			0.148	
L2	1.14		1.70	0.045		0.067
L3	2.65		2.95	0.104		0.116
V1		45°			45°	

Product Selector

Part Number	Gate Sensitivity	Type	Package
SK225LD	40mA	Standard SCR	TO-220L
SK225RD	40mA	Standard SCR	TO-220R

Packing Options

Part Number	Marking	Weight	Packing Mode	Base Quantity
SK225LDTP	SK225LD	2.2g	Tube	1000
SK225RDTP	SK225RD	2.0g	Tube	1000

Part Numbering System

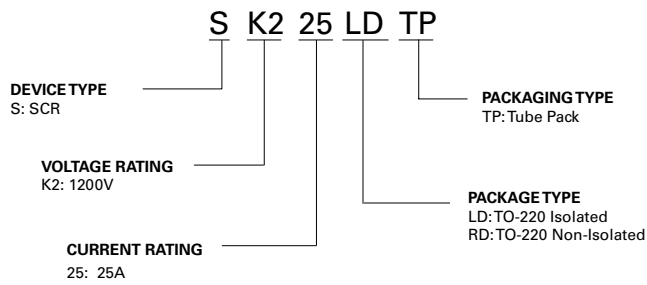

Part Marking System

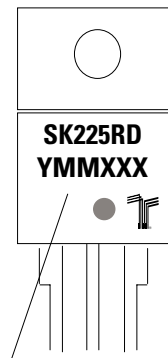

Date Code Marking
 Y: Year Code
 MM: Month Code
 XXX: Lot Trace Code

Disclaimer Notice - Information furnished is believed to be accurate and reliable. However, users should independently evaluate the suitability of and test each product selected for their own applications. Littelfuse products are not designed for, and may not be used in, all applications. Read complete Disclaimer Notice at <http://www.littelfuse.com/disclaimer-electronics>.