

SVxx12xxQ series

12 Amp High Junction Temperature SCRs

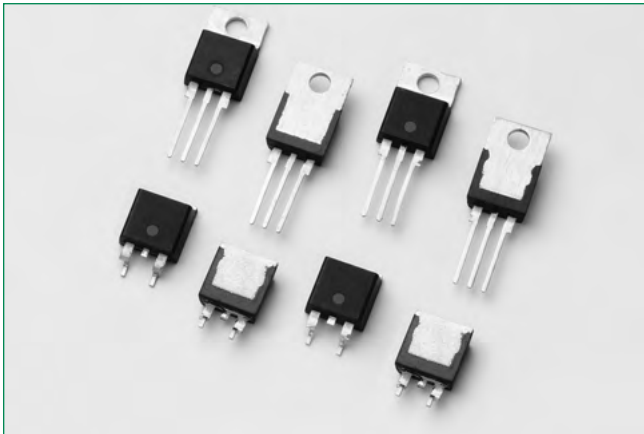

Agency Approval

Agency	Agency File Number
	E71639*

*L Packages only

Main Features

Symbol	Value	Unit
$I_{T(RMS)}$	12	A
V_{DRM}/V_{RRM}	600	V
I_{GT}	6 to 10	mA

Schematic Symbol

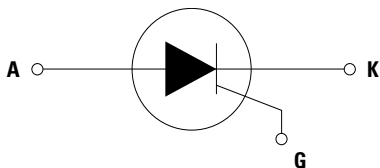

Description

The SVxx12xxQ high junction temperature SCR series is ideal for uni-directional switch applications such as phase control in heating, motor speed controls, converters/rectifiers, inrush current control and capacitive discharge ignitions.

These SCRs have a low gate current, (IGT) trigger level of 6mA and 10mA maximum at approximately 1.5V for SVxx12x1Q and SVxx12x2Q, respectively.

Features & Benefits

- Halogen-free and RoHS compliant
- 150°C maximum junction temperature
- Surge capability up to 120 A at 60 Hz half cycle
- High dv/dt performance
- Low turn off time
- Recognized to UL 1557 as an Electrically Isolated Semiconductor Device

Applications

Typical applications include AC Generator (ACG) rectifiers, battery voltage regulators and generic converters and inrush current controller in various AC to DC applications. Additional applications include controls for power tools, home/brown good and white goods appliances.

Internally constructed isolated packages offered for ease of heat sinking with high isolation voltage.

SVxx12xxQ series

12 Amp High Junction Temperature SCRs

Absolute Maximum Ratings

Symbol	Parameter	Test Conditions	Value	Unit
V_{DSM}/V_{RSM}	Peak non-repetitive blocking voltage	$P_W = 100 \mu s$	800	V
$I_{T(RMS)}$	RMS on-state current	SVxx12LxQ SVxx12RxQ SVxx12NxQ	$T_C = 110^\circ C$ $T_C = 135^\circ C$	12 A
$I_{T(AV)}$	Average on-state current	SVxx12LxQ SVxx12RxQ SVxx12NxQ	$T_C = 110^\circ C$ $T_C = 135^\circ C$	7.6 A
I_{TSM}	Peak non-repetitive surge current (single half cycle, T_J (initial) = $25^\circ C$)		$f = 50Hz$ $f = 60Hz$	150 180 A
I^2t	I^2t Value for fusing		$t_p = 8.3 ms$	135 A^2s
di/dt	Critical rate of rise of on-state current		$f = 60Hz; T_J = 150^\circ C$	100 $A/\mu s$
I_{GM}	Peak gate current		$T_J = 150^\circ C$	4 A
$P_{G(AV)}$	Average gate power dissipation		$T_J = 150^\circ C$	0.8 W
T_{stg}	Storage temperature range			-40 to 150 $^\circ C$
T_J	Operating junction temperature range			-40 to 150 $^\circ C$

Note: xx=voltage/10, x=sensitivity

Electrical Characteristics ($T_J = 25^\circ C$, unless otherwise specified)

Symbol	Test Conditions		SVxx12x1Q	SVxx12x2Q	Unit
I_{GT}	$V_D = 12V$ $R_L = 60 \Omega$	MAX.	6	10	mA
		MIN.	2	5	
V_{GT}	$V_D = 12V$ $R_L = 60 \Omega$	MAX.	1.5	1.5	V
dv/dt	$V_D = 67\% V_{DRM}$; gate open; $T_J = 125^\circ C$	MIN.	400	800	$V/\mu s$
	$V_D = 67\% V_{DRM}$; gate open; $T_J = 150^\circ C$		200	400	
V_{GD}	$V_D = V_{DRM}$ $R_L = 3.3 k\Omega$ $T_J = 150^\circ C$	MIN.	0.2	0.2	V
I_H	$I_T = 200mA$ (initial)	MAX.	25	40	mA
t_q	$I_T = 2A$; $t_p = 50\mu s$; $dv/dt = 5V/\mu s$; $di/dt = 30A/\mu s$	MAX.	12	12	μs
t_{gt}	$I_G = 2 \times I_{GT}$ $P_W = 15\mu s$ $I_T = 24A$	TYP.	2.6	2.6	μs

Static Characteristics

Symbol	Test Conditions	Value	Unit
V_{TM}	$I_T = 24A$; $t_p = 380 \mu s$	MAX.	1.65 V
I_{DRM} / I_{RRM}	$V_{DRM} = V_{RRM}$	MAX.	$T_J = 25^\circ C$ 10 $T_J = 125^\circ C$ 500 $T_J = 150^\circ C$ 2000 μA

Thermal Resistances

Symbol	Parameter	Value	Unit
$R_{\theta(JC)}$	Junction to case (AC)	SVxx12LxQ	2.5
		SVxx12RxQ	1.1
		SVxx12NxQ	

Note: xx=voltage/10, x=sensitivity

SVxx12xxQ series

12 Amp High Junction Temperature SCRs

Figure 1:
Normalized DC Gate Trigger Current vs. Junction Temperature

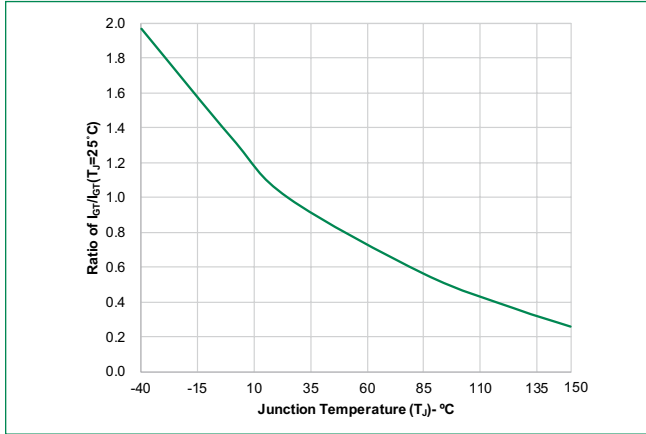

Figure 2:
Normalized DC Gate Trigger Voltage vs. Junction Temperature

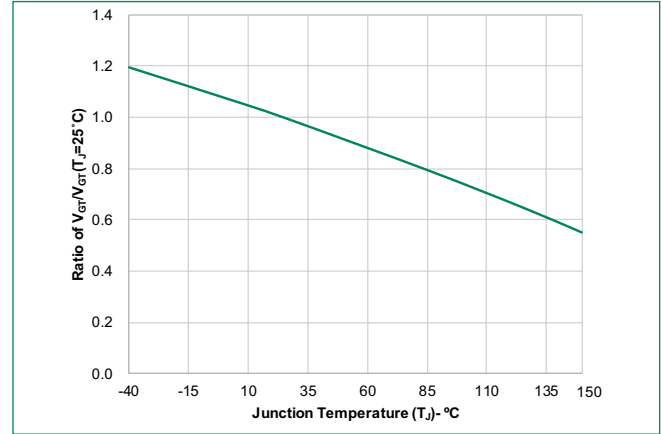

Figure 3:
Normalized DC Holding Current vs. Junction Temperature

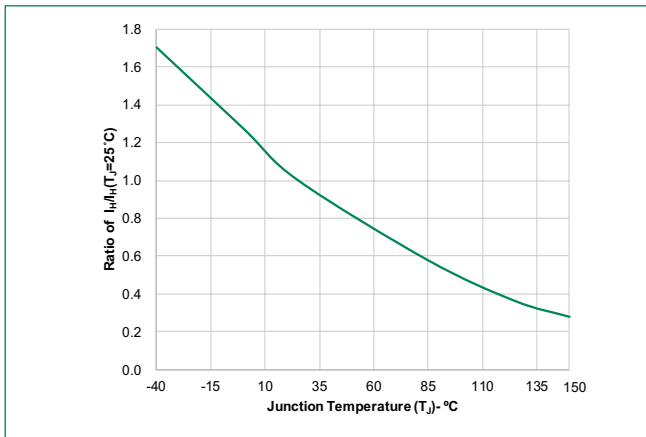

Figure 4:
On-State Current vs. On-State Voltage (Typical)

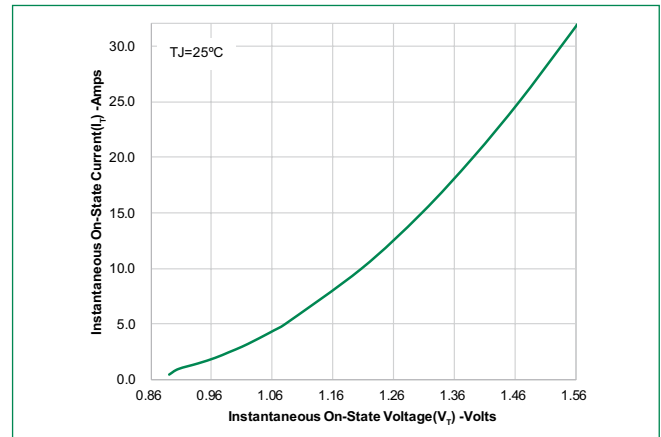

Figure 5:
Power Dissipation (Typical) vs. RMS On-State Current

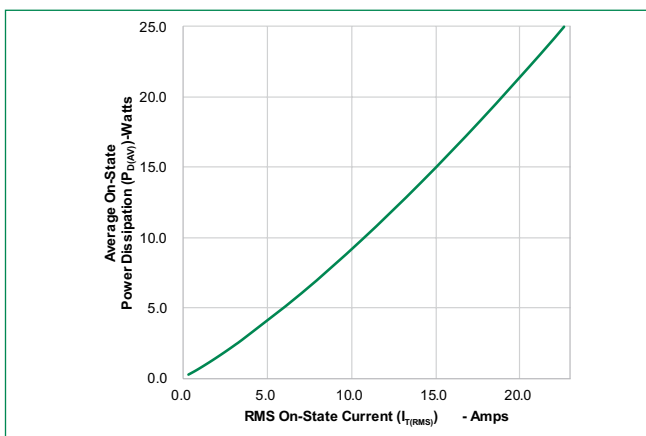
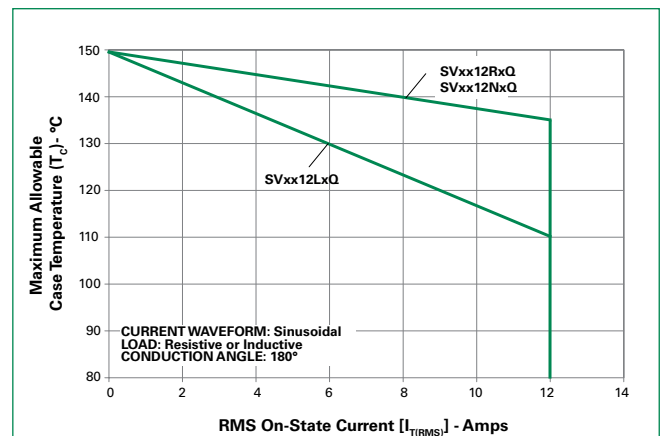

Figure 6:
Maximum Allowable Case Temperature vs. RMS On-State Current



SVxx12xxQ series

12 Amp High Junction Temperature SCRs

Figure 7:
Maximum Allowable Case Temperature v s. Average On-State Current

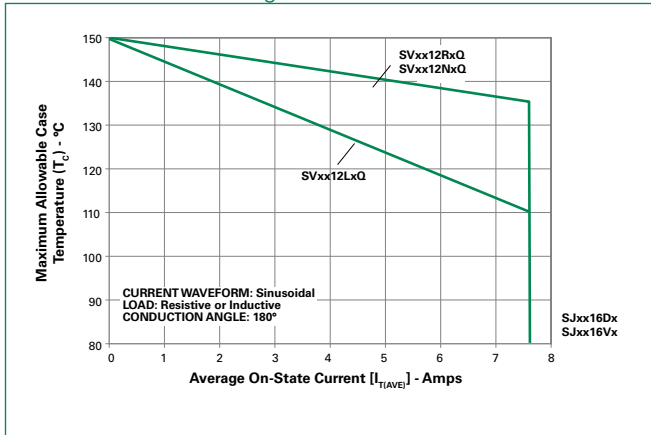

Figure 8:
Peak Capacitor Discharge Current

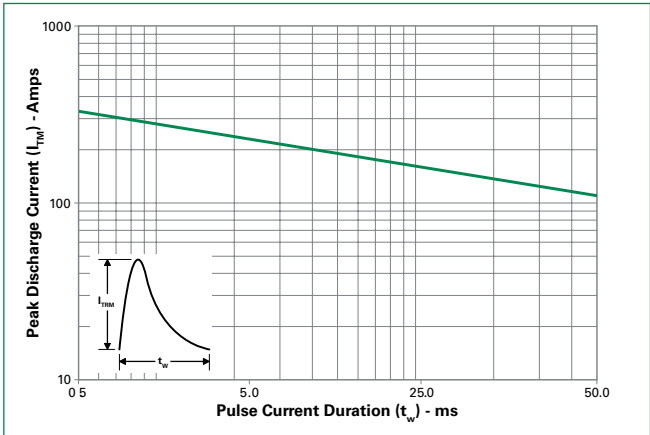

Figure 9:
Peak Capacitor Discharge Current Derating

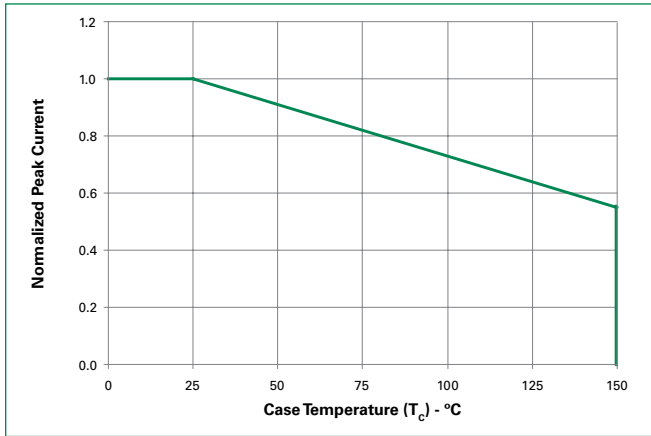
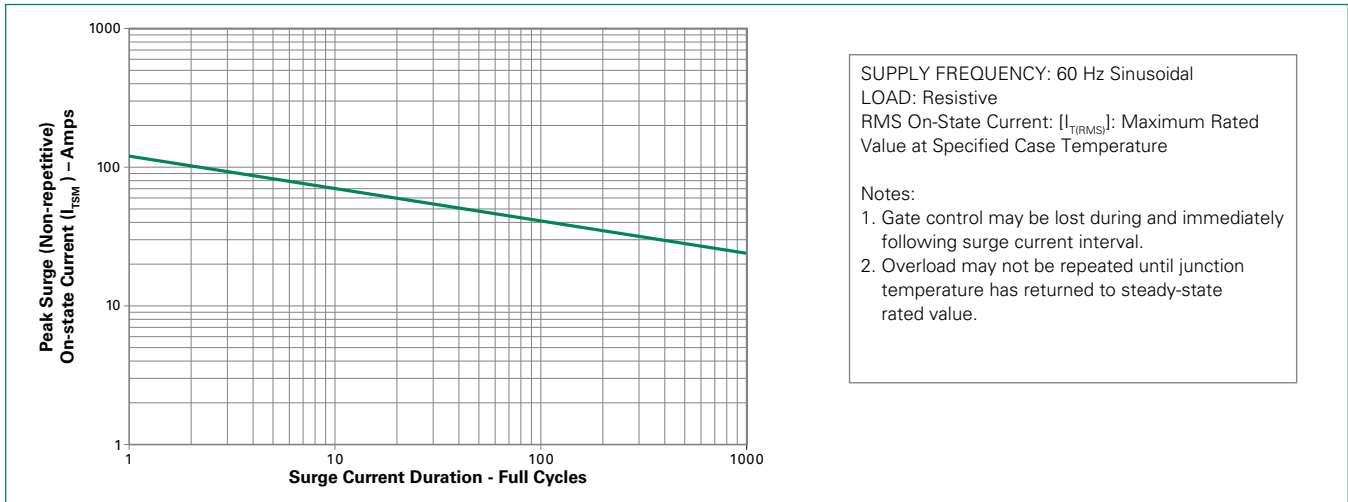

Figure 10: Surge Peak On-State Current vs. Number of Cycles



SVxx12xxQ series

12 Amp High Junction Temperature SCRs

Soldering Parameters

Reflow Condition		Pb – Free assembly
Pre Heat	- Temperature Min ($T_{s(min)}$)	150°C
	- Temperature Max ($T_{s(max)}$)	200°C
	- Time (min to max) (t_s)	60 – 180 secs
Average ramp up rate (Liquidus Temp) (T_L) to peak		5°C/second max
$T_{s(max)}$ to T_L - Ramp-up Rate		5°C/second max
Reflow	- Temperature (T_L) (Liquidus)	217°C
	- Time (t_L)	60 – 150 seconds
Peak Temperature (T_p)		260 ^{+0/-5} °C
Time within 5°C of actual peak Temperature (t_p)		20 – 40 seconds
Ramp-down Rate		5°C/second max
Time 25°C to peak Temperature (T_p)		8 minutes Max.
Do not exceed		280°C

Physical Specifications

Terminal Finish	100% Matte Tin-plated
Body Material	UL Recognized compound meeting flammability rating V-0
Lead Material	Copper Alloy

Design Considerations

Careful selection of the correct component for the application's operating parameters and environment will go a long way toward extending the operating life of the Thyristor. Good design practice should limit the maximum continuous current through the main terminals to 75% of the component rating. Other ways to ensure long life for a power discrete semiconductor are proper heat sinking and selection of voltage ratings for worst case conditions. Overheating, overvoltage (including dv/dt), and surge currents are the main killers of semiconductors. Correct mounting, soldering, and forming of the leads also help protect against component damage.

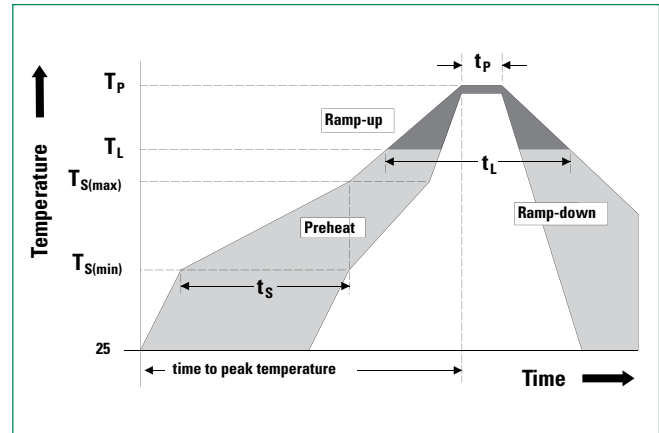

Environmental Specifications

Test	Specifications and Conditions
AC Blocking	MIL-STD-750, M-1040, Cond A Applied Peak AC voltage @ 150°C for 1008 hours
Temperature Cycling	MIL-STD-750, M-1051, 1000 cycles; -55°C to +150°C; 15-min dwell-time
Temperature/Humidity	EIA / JEDEC, JESD22-A101 1008 hours; 160V - DC: 85°C; 85% rel humidity
Resistance to Solder Heat	MIL-STD-750 Method 2031
Solderability	ANSI/J-STD-002, category 3, Test A
Lead Bend	MIL-STD-750, M-2036 Cond E
Moisture Sensitivity Level	Level 1, JEDEC-J-STD-020D

SVxx12xxQ series

12 Amp High Junction Temperature SCRs

Dimensions – TO-220AB (L-Package) – Isolated Mounting Tab

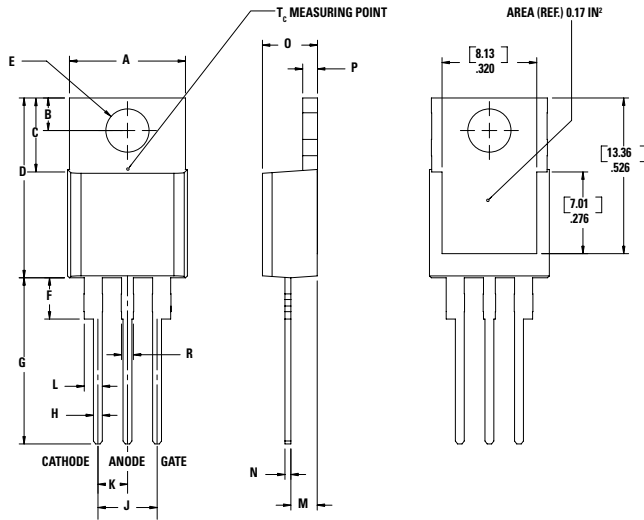

Dimension	Inches		Millimeters	
	Min	Max	Min	Max
A	0.380	0.420	9.65	10.67
B	0.105	0.115	2.67	2.92
C	0.230	0.250	5.84	6.35
D	0.590	0.620	14.99	15.75
E	0.142	0.147	3.61	3.73
F	0.110	0.130	2.79	3.30
G	0.540	0.575	13.72	14.61
H	0.025	0.035	0.64	0.89
J	0.195	0.205	4.95	5.21
K	0.095	0.105	2.41	2.67
L	0.060	0.075	1.52	1.91
M	0.085	0.095	2.16	2.41
N	0.018	0.024	0.46	0.61
O	0.178	0.188	4.52	4.78
P	0.045	0.060	1.14	1.52
R	0.038	0.048	0.97	1.22

Dimensions – TO-220AB (R-Package) – Non-Isolated Mounting Tab Common with Center Lead

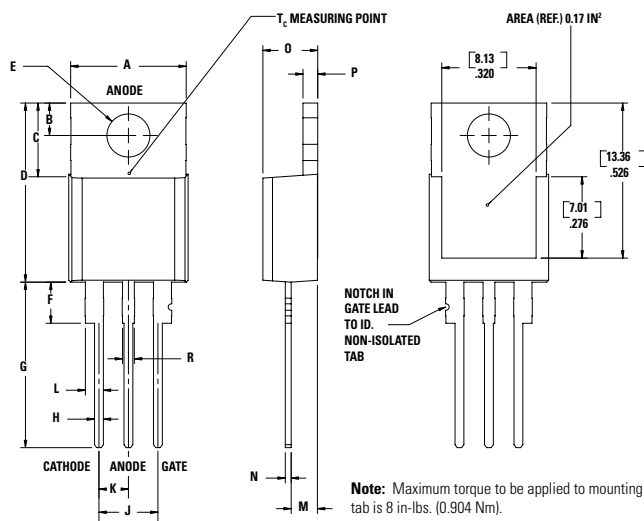

Dimension	Inches		Millimeters	
	Min	Max	Min	Max
A	0.380	0.420	9.65	10.67
B	0.105	0.115	2.67	2.92
C	0.230	0.250	5.84	6.35
D	0.590	0.620	14.99	15.75
E	0.142	0.147	3.61	3.73
F	0.110	0.130	2.79	3.30
G	0.540	0.575	13.72	14.61
H	0.025	0.035	0.64	0.89
J	0.195	0.205	4.95	5.21
K	0.095	0.105	2.41	2.67
L	0.060	0.075	1.52	1.91
M	0.085	0.095	2.16	2.41
N	0.018	0.024	0.46	0.61
O	0.178	0.188	4.52	4.78
P	0.045	0.060	1.14	1.52
R	0.038	0.048	0.97	1.22

SVxx12xxQ series

12 Amp High Junction Temperature SCRs

Dimensions – TO- 263AB (N-package) – D2-Pak Surface Mount

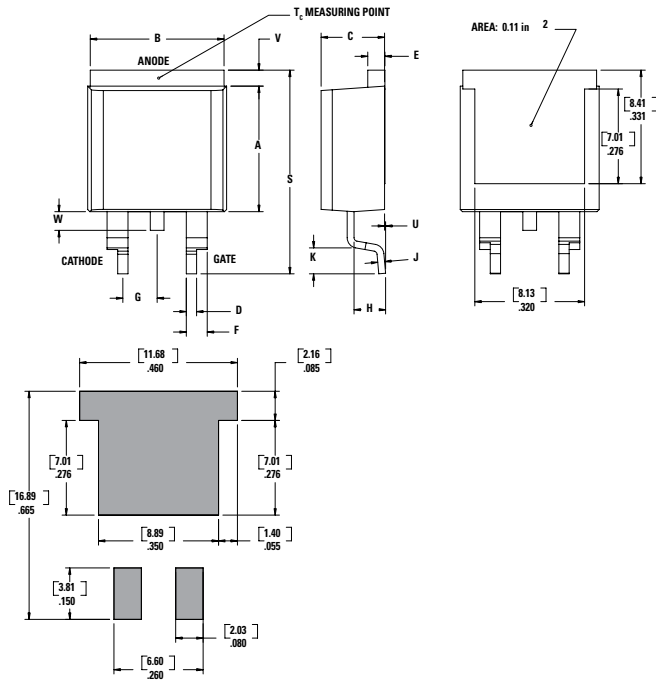

Dimension	Inches		Millimeters	
	Min	Max	Min	Max
A	0.360	0.370	9.14	9.40
B	0.380	0.420	9.65	10.67
C	0.178	0.188	4.52	4.78
D	0.025	0.035	0.64	0.89
E	0.045	0.060	1.14	1.52
F	0.060	0.075	1.52	1.91
G	0.095	0.105	2.41	2.67
H	0.092	0.102	2.34	2.59
J	0.018	0.024	0.46	0.61
K	0.090	0.110	2.29	2.79
S	0.590	0.625	14.99	15.88
V	0.035	0.045	0.89	1.14
U	0.002	0.010	0.05	0.25
W	0.040	0.070	1.02	1.78

Product Selector

Part Number	Voltage	Gate Sensitivity	Type	Package
	600V			
SVxx12L1Q	X	6mA	Standard SCR	TO-220L
SVxx12R1Q	X	6mA	Standard SCR	TO-220R
SVxx12N1Q	X	6mA	Standard SCR	TO-263
SVxx12L2Q	X	10mA	Standard SCR	TO-220L
SVxx12R2Q	X	10mA	Standard SCR	TO-220R
SVxx12N2Q	X	10mA	Standard SCR	TO-263

Note: xx = Voltage/10

Packing Options

Part Number	Marking	Weight	Packing Mode	Base Quantity
SVxx12LxQTP	SVxx12LxQ	2.2g	Tube	1000 (50 per tube)
SVxx12RxQTP	SVxx12RxQ	2.2g	Tube	1000 (50 per tube)
SVxx12NxQTP	SVxx12NxQ	1.6g	Tube	1000 (50 per tube)
SVxx12NxQRP	SVxx12NxQ	1.6g	Embossed Carrier	500

Note: xx=voltage/10, x=sensitivity

