

### AK6 Series



#### Agency Approvals

AGENCY	AGENCY FILE NUMBER
	E128662

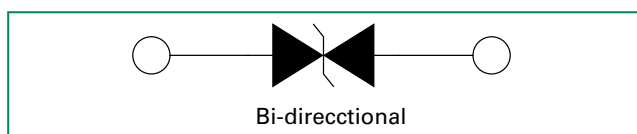
#### Maximum Ratings and Thermal Characteristics (T<sub>A</sub>=25°C unless otherwise noted)

Parameter	Symbol	Value	Unit
Operating Storage Temperature Range	T <sub>STG</sub>	-55 to 150	°C
Operating Junction Temperature Range	T <sub>J</sub>	-55 to 125	°C
Current Rating <sup>1</sup>	I <sub>PP</sub>	6	kA

**Note:**

1. Rated I<sub>PP</sub> measured with 8/20µS pulse.

#### Functional Diagram



#### Description

The AK6 series of high power TVS diode is specially designed for meeting severe surge test environment of both AC and DC line protection applications. It features a very fast response and ultra low clamping characteristics over traditional metal oxide (MOV) solutions. They can be connected in series and / or parallel to create a very high surge current protection solution.

#### Features

- Very low clamping voltage
- Ultra compact: less than one-tenth the size of traditional discrete solutions
- Sharp breakdown voltage
- Low slope resistance
- Bi-directional
- Foldbak technology for superior clamping factor
- Symmetric in leads width for easier soldering during assembly.
- IEC-61000-4-2 ESD 15kV(Air), 8kV (Contact)
- ESD protection of data lines in accordance with IEC 61000-4-2
- EFT protection of data lines in accordance with IEC 61000-4-4
- Halogen-free
- RoHS compliant
- Glass passivated junction
- Pb-free E4 means 2nd level interconnect is Pb-free and the terminal finish material is silver

#### Additional Information




Datasheet



Resources



Samples

Part Numbers	Part Marking	Standoff Voltage (V <sub>SO</sub> ) Volts	Max. Reverse Leakage (I <sub>R</sub> ) @ V <sub>SO</sub> µA	Typical I <sub>R</sub> @ 85°C (µA)	Reverse Breakdown Voltage (V <sub>BR</sub> ) @ I <sub>T</sub>		Test Current I <sub>T</sub> (mA)	Max. Clamping Voltage V <sub>CL</sub> @ I <sub>PP</sub> Peak Pulse Current (I <sub>PP</sub> ) (Note 1)		Max. Temp Coefficient OF V <sub>BR</sub> (%/°C)	Max. Capacitance 0 Bias 10kHz (nF)	Agency Approval 
					Min Volts	Max Volts		V <sub>CL</sub> Volts	I <sub>PP</sub> Amps			
AK6 - 030C	6 - 030C	30	10	15	32	37	10	90	6,000	0.1	11.0	X
AK6 - 058C	6 - 058C	58	10	15	64	70	10	110	6,000	0.1	8.0	X
AK6 - 066C	6 - 066C	66	10	15	72	80	10	120	6,000	0.1	6.0	X
AK6 - 076C	6 - 076C	76	10	15	85	95	10	140	6,000	0.1	6.5	X
AK6 - 170C	6 - 170C	170	10	15	180	220	10	260	6,000	0.1	2.8	X
AK6 - 190C	6 - 190C	190	10	15	200	245	10	290	6,000	0.1	2.5	X
AK6 - 240C	6 - 240C	240	10	15	250	285	10	340	6,000	0.1	2.0	X
AK6 - 380C	6 - 380C	380	10	15	401	443	10	520	6,000	0.1	1.4	X
AK6 - 430C	6 - 430C	430	10	15	440	490	10	625	6,000	0.1	1.0	X

**Note:** Using 8/20µS wave shape as defined in IEC 61000-4-5.

### Physical Specifications

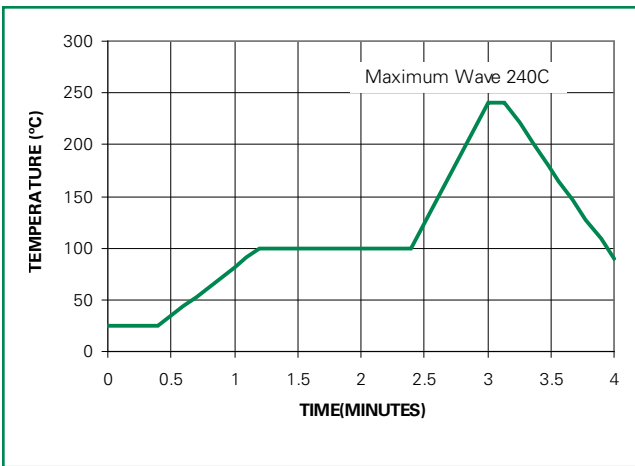
<b>Weight</b>	Contact manufacturer
<b>Case</b>	Epoxy encapsulated
<b>Terminal</b>	Silver plated leads, solderable per MIL-STD-750 Method 2026

### Flow/Wave Soldering (Solder Dipping)

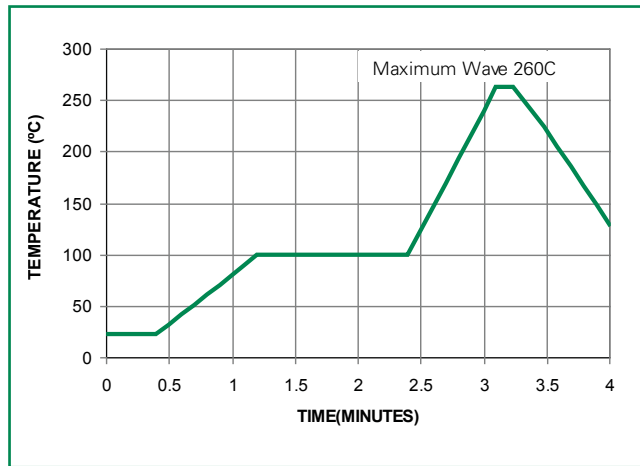
<b>Peak Temperature :</b>	265°C
<b>Dipping Time :</b>	10 seconds
<b>Soldering :</b>	1 time

### Wave Solder Profile

**Figure 1 - Non Lead-free Profile**

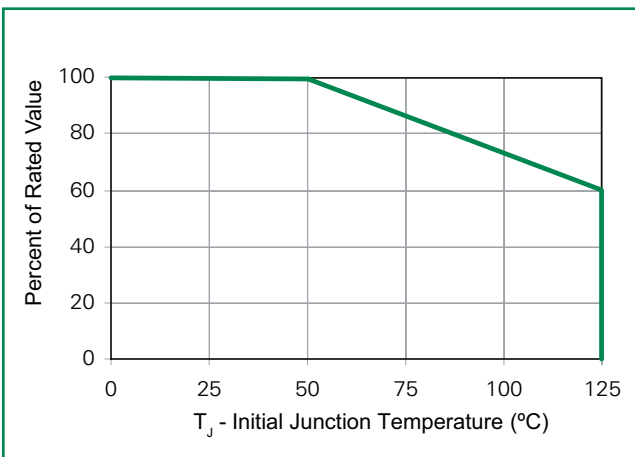


**Figure 2 - Lead-free Profile**

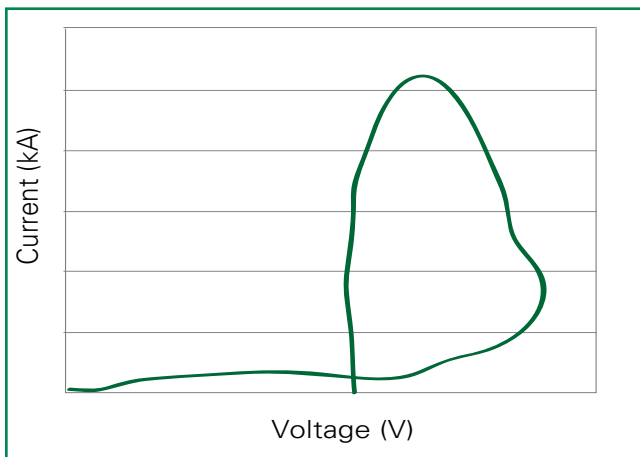


### Ratings and Characteristic Curves (T<sub>j</sub>=25°C unless otherwise noted)

**Figure 3 - Peak Power Derating**



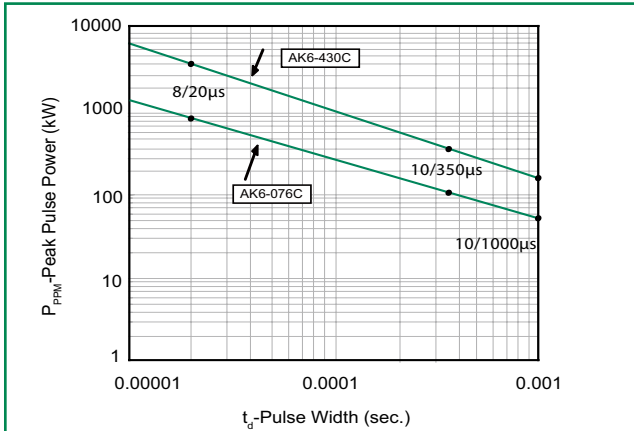
**Figure 4 - Surge Response**



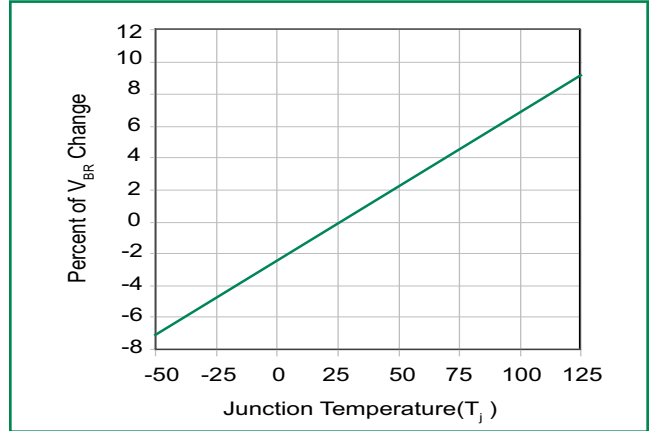
continues on next page.

### Ratings and Characteristic Curves ( $T_A=25^\circ\text{C}$ unless otherwise noted) (Continued)

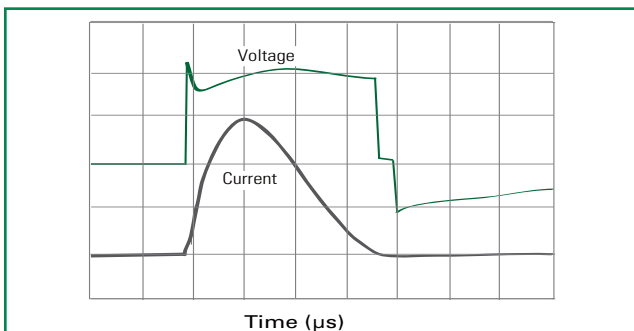
**Figure 5 - Typical Peak Pulse Power Rating Curve**



**Figure 6 - Typical  $V_{BR}$  Vs Junction Temperature**



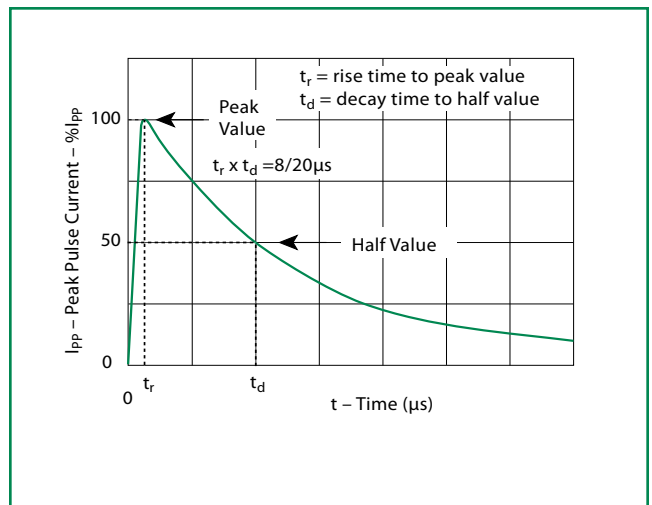
**Figure 7 -Surge Response (8/20 Surge current waveform)**



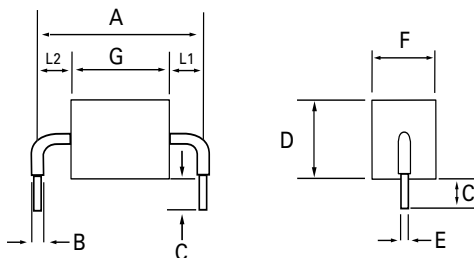
Note:

The power dissipation causes a change in avalanche voltage during the surge and the avalanche voltage eventually returns to the original value when the transient has passed.

**Figure 8 - Pulse Waveform**

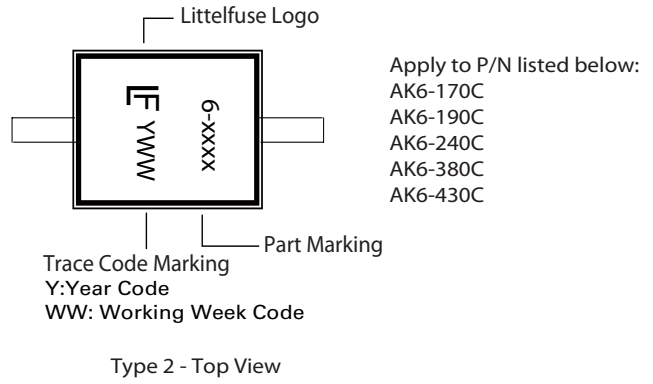
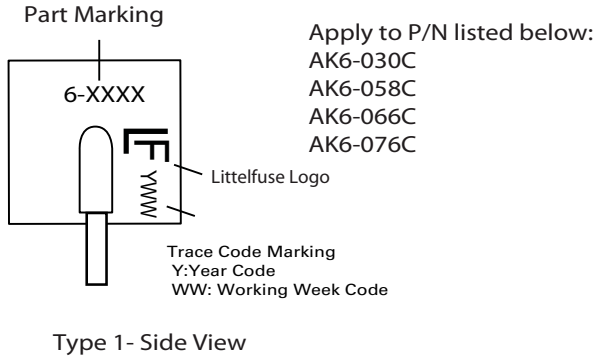


### Dimensions

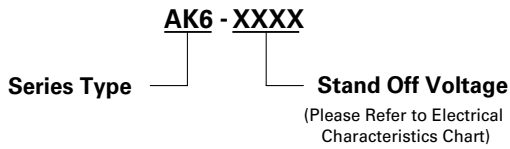


Dimensions	Inches	Millimeters
A	0.950 +/- 0.040	24.15 +/- 1.00
B	0.095 +/- 0.024	2.4 +/- 0.60
C	0.236 +/- 0.040	6.00 +/- 1.00
D	0.570 max.	14.48 max.
E	0.050 +/- 0.002	1.270 +/- 0.05
F	0.500 max.	12.70 max.
G - 030C	0.161 +/- 0.040	4.10 +/- 1.00
G - 058C/066C 076C	0.189 +/- 0.040	4.8 +/- 1.00
G - 170C/190C	0.320 +/- 0.040	8.13 +/- 1.00
G - 240C	0.370 +/- 0.040	9.4 +/- 1.00
G - 380C/430C	0.543 +/- 0.040	13.8 +/- 1.00
L1/L2	L1= L2 tolerance +/- 0.04 inch (1.0 mm)	

### Part Marking System



### Part Numbering System



### Packing Options

Part Number	Component Package	Quantity	Packaging Option
AK6-XXXX	AK Package	56pcs/Box	Bulk
AK6-XXXX-12	AK Package	12pcs/Box	Bulk