

SP1005 Series 30pF 30kV Bidirectional Discrete TVS

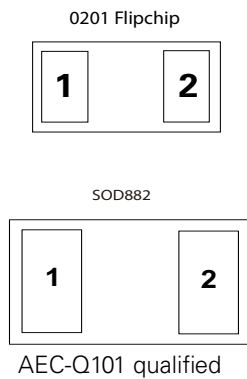

Pinout



Functional Block Diagram

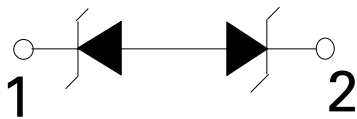

Additional Information



Datasheet



Resources



Samples

Description

The SP1005 includes back-to-back Zener diodes fabricated in a proprietary silicon avalanche technology to provide protection for electronic equipment that may experience destructive electrostatic discharges (ESD). These robust diodes can safely absorb repetitive ESD strikes above the maximum level specified in the IEC 61000-4-2 international standard (Level 4, ±8kV contact discharge) without performance degradation. The back-to-back configuration provides symmetrical ESD protection for data lines when AC signals are present.

Features

- ESD, IEC 61000-4-2, ±30kV contact, ±30kV air
- EFT, IEC 61000-4-4, 40A (5/50ns)
- Lightning, IEC 61000-4-5 (2nd Ed.), 10A ($t_p=8/20\mu s$)
- Low capacitance of 30pF (@ $V_R=0V$)
- Low leakage current of 0.1µA at 5V
- Space efficient 0201 and 0402 footprint
- AEC-Q101 qualified (SOD882 package)

Applications

- Mobile Phones
- Smart Phones
- Camcorders
- Portable Medical
- Digital Cameras
- MP3/PMP
- Portable Navigation Devices
- Tablets
- Point of Sale Terminals

Application Example

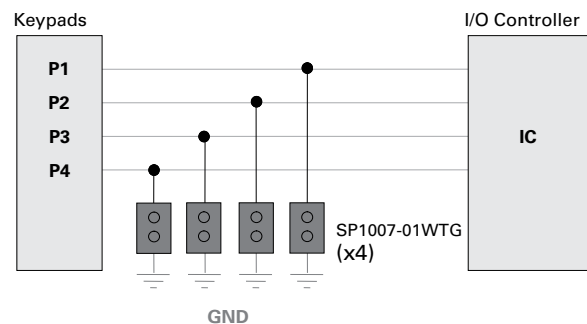

Life Support Note:

Not Intended for Use in Life Support or Life Saving Applications

The products shown herein are not designed for use in life sustaining or life saving applications unless otherwise expressly indicated.

Absolute Maximum Ratings

Symbol	Parameter	Value	Units
I_{PP}	Peak Current ($t_p=8/20\mu s$)	10.0 ¹	A
		8.0 ²	
T_{OP}	Operating Temperature	-40 to 125	°C
T_{STOR}	Storage Temperature	-55 to 150	°C

Notes:

- "1" indicates SP1005-01WTG, while "2" indicates SP1005-01ETG
- CAUTION: Stresses above those listed in "Absolute Maximum Ratings" may cause permanent damage to the device. This is a stress only rating and operation of the device at these or any other conditions above those indicated in the operational sections of this specification is not implied.

Thermal Information

Parameter	Rating	Units
Storage Temperature Range	-55 to 150	°C
Maximum Junction Temperature	150	°C
Maximum Lead Temperature (Soldering 20-40s)	260	°C

Electrical Characteristics ($T_{OP}=25^\circ C$)

Parameter	Symbol	Test Conditions	Min	Typ	Max	Units
Reverse Standoff Voltage	V_{RWM}				6.0	V
Breakdown Voltage	V_{BR}	$I_R=1mA$		8.5	9.5	V
Leakage Current	I_{LEAK}	$V_R=5V$ with 1 pin at GND		0.1	0.5	μA
Clamp Voltage ¹	V_C	$I_{pp}=1A, t_p=8/20\mu s, Fwd$		9.3		V
		$I_{pp}=2A, t_p=8/20\mu s, Fwd$		10.0		V
		$I_{pp}=10A, t_p=8/20\mu s, Fwd$		15.6		V
Dynamic Resistance ²	R_{DYN}	TLP, $t_p=100ns, I/O$ to GND		0.28		Ω
ESD Withstand Voltage ¹	V_{ESD}	IEC61000-4-2 (Contact Discharge)	± 30			kV
		IEC61000-4-2 (Air Discharge)	± 30			kV
Diode Capacitance ¹	C_D	Reverse Bias=0V		30		pF
		Reverse Bias=2.5V		23		pF

Notes:

- Parameter is guaranteed by design and/or device characterization.
- Transmission Line Pulse (TLP) with 100ns width and 200ns rise time.

Capacitance vs. Reverse Bias

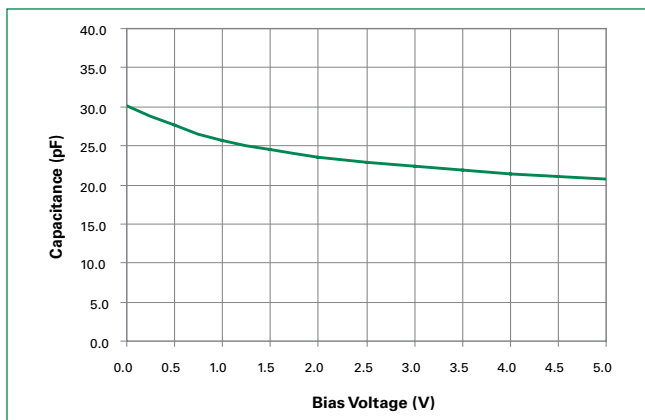

Pulse Waveform

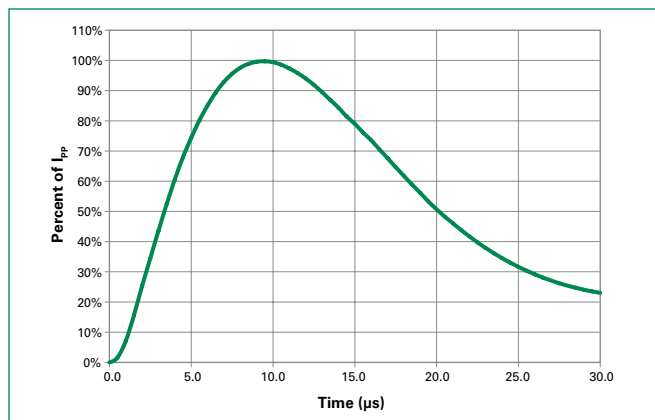

Clamping Voltage vs. I_{pp}

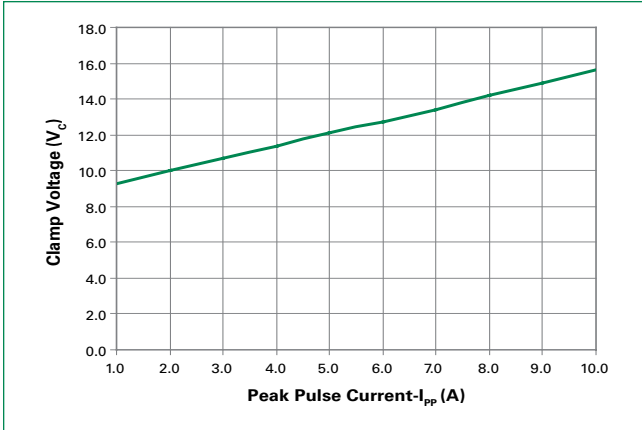

Insertion Loss (S21) I/O to GND

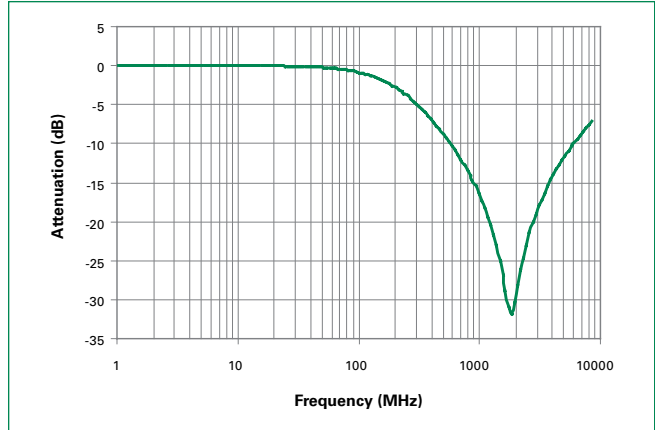

Transmission Line Pulsing (TLP) Plot

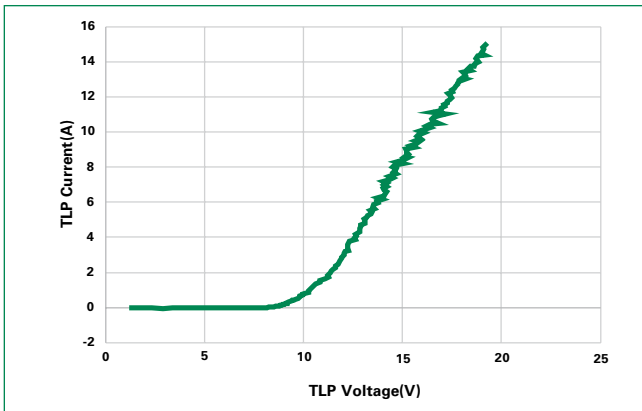

Product Characteristics of SOD-882 Package

Lead Plating	Pre-Plated Frame
Lead Material	Copper Alloy
Lead Coplanarity	0.0004 inches (0.102mm)
Substitute Material	Silicon
Body Material	Molded Epoxy
Flammability	UL 94 V-0

- Notes :
1. All dimensions are in millimeters
 2. Dimensions include solder plating.
 3. Dimensions are exclusive of mold flash & metal burr.
 4. Blo is facing up for mold and facing down for trim/form, i.e. reverse trim/form.
 5. Package surface matte finish VDI 11-13.

Soldering Parameters

Reflow Condition		Pb – Free assembly
Pre Heat	- Temperature Min ($T_{s(min)}$)	150°C
	- Temperature Max ($T_{s(max)}$)	200°C
	- Time (min to max) (t_p)	60 – 180 secs
Average ramp up rate (Liquidus) Temp (T_L) to peak		3°C/second max
$T_{s(max)}$ to T_L - Ramp-up Rate		3°C/second max
Reflow	- Temperature (T_L) (Liquidus)	217°C
	- Temperature (t_L)	60 – 150 seconds
Peak Temperature (T_p)		260 ^{+0.5} °C
Time within 5°C of actual peak Temperature (t_p)		20 – 40 seconds
Ramp-down Rate		6°C/second max
Time 25°C to peak Temperature (T_p)		8 minutes Max.
Do not exceed		260°C

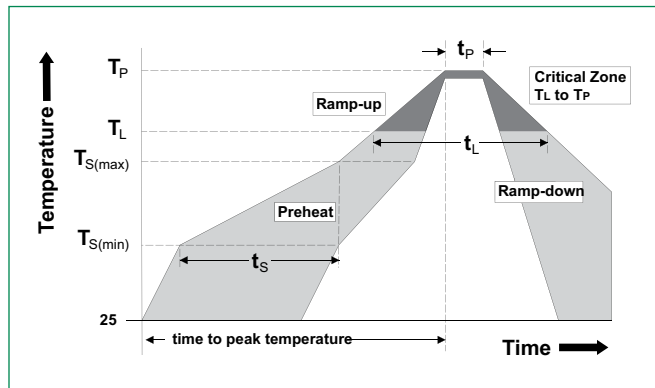

Part Marking System

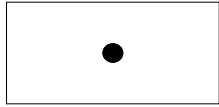

SP1005-01WTG

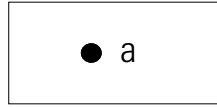

SP1005-01ETG

Part Numbering System

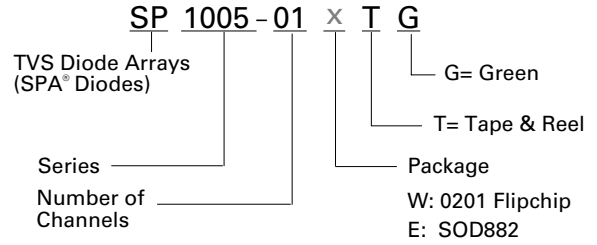

Ordering Information

Part Number	Package	Marking	Min. Order Qty.
SP1005-01WTG	0201 Flipchip	•	10,000
SP1005-01ETG	SOD882	•a	10,000

Package Dimensions — 0201 Flipchip

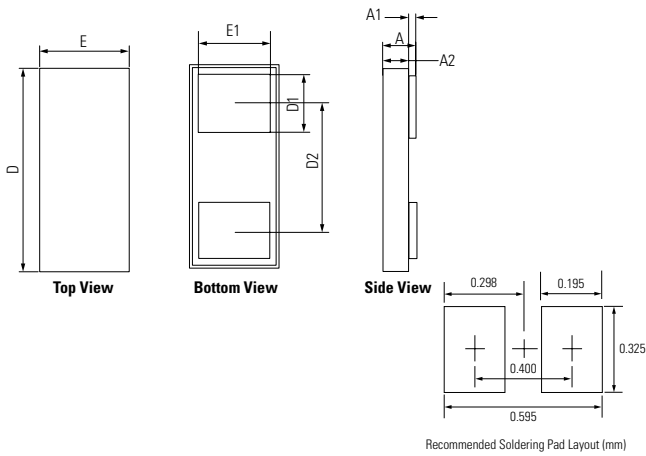

Symbol	0201 Flipchip			
	Millimeters		Inches	
	Min	Max	Min	Max
D	0.605	0.655	0.0238	0.0258
E	0.305	0.345	0.0120	0.0140
D1	0.145	0.155	0.0057	0.0061
E1	0.245	0.255	0.0096	0.0100
D2	0.400 BSC		0.0157 BSC	
A	0.273	0.329	0.0107	0.0130
A2	0.265	0.315	0.0104	0.0124
A1	0.008	0.014	0.0003	0.0006

Package Dimensions — SOD882

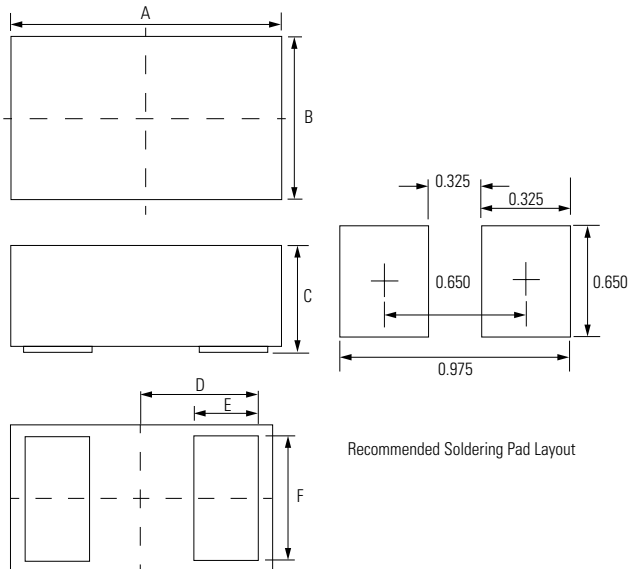

Symbol	Package	SOD882				
	JEDEC	MO-236				
	Millimeters			Inches		
	Min	Typ	Max	Min	Typ	Max
A	0.90	1.00	1.10	0.035	0.039	0.043
B	0.50	0.60	0.70	0.020	0.024	0.028
C	0.40	0.50	0.60	0.016	0.020	0.024
D	0.45			0.018		
E	0.20	0.25	0.35	0.008	0.010	0.012
F	0.45	0.50	0.55	0.018	0.020	0.022

Embossed Carrier Tape & Reel Specification – 0201 Flipchip

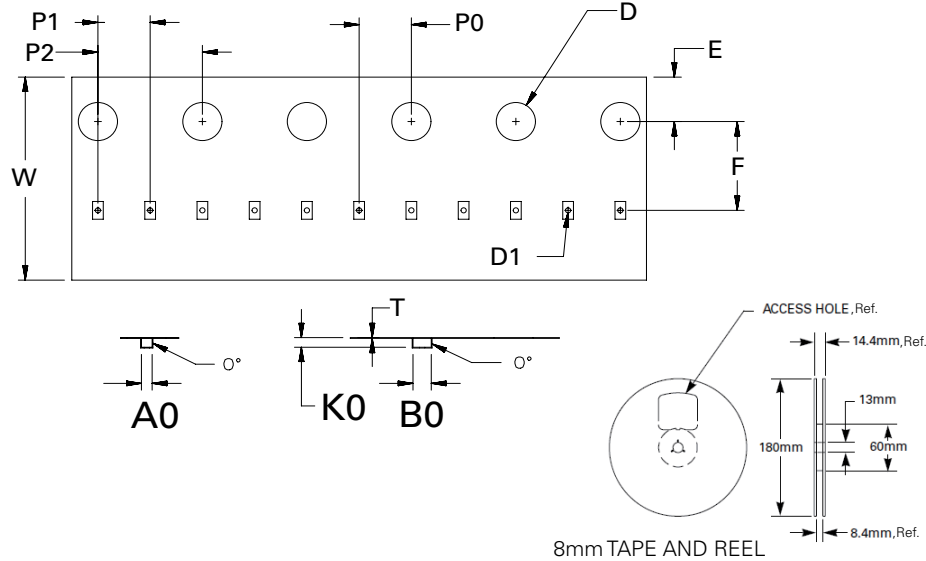

Symbol	Millimeters
A0	0.41+/-0.03
B0	0.70+/-0.03
D	ø 1.50 + 0.10
D1	ø 0.20 +/- 0.05
E	1.75+/-0.10
F	3.50+/-0.05
K0	0.38+/-0.03
P0	2.00+/-0.05
P1	2.00+/-0.05
P2	4.00+/-0.10
W	8.00 + 0.30 -0.10
T	0.23+/-0.02

Embossed Carrier Tape & Reel Specification – SOD882

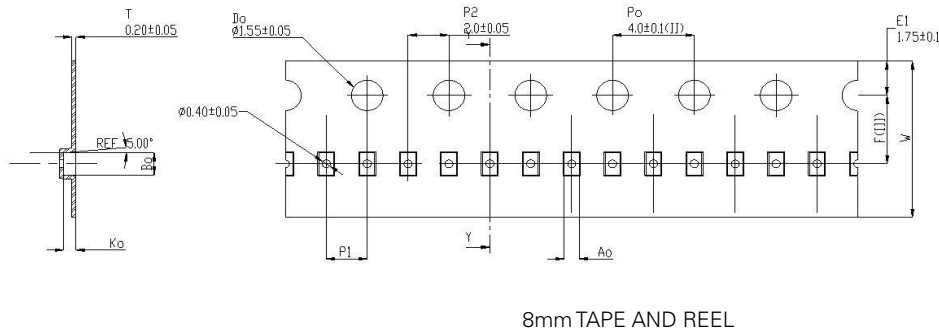

Symbol	Millimeters
A0	0.70+/-0.045
B0	1.10+/-0.045
K0	0.65+/-0.045
F	3.50+/-0.05
P1	2.00+/-0.10
W	8.00 + 0.30 -0.10

Disclaimer Notice - Information furnished is believed to be accurate and reliable. However, users should independently evaluate the suitability of and test each product selected for their own applications. Littelfuse products are not designed for, and may not be used in, all applications. Read complete Disclaimer Notice at <http://www.littelfuse.com/disclaimer-electronics>.