

SP1124T Discrete Unidirectional TVS Diode

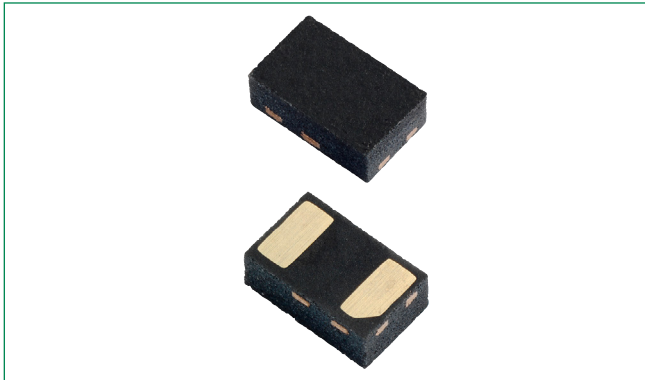

OBSOLETE DATE: 06/10th/2020 PCN/ECN# ESU270-51
REPLACED BY: SP1124-01UTG



Pinout and Functional Block Diagram

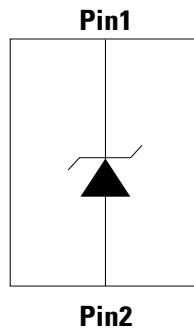

Description

This TVS diode is fabricated in a proprietary silicon avalanche technology and is used for high level protection of electronic equipment that may experience destructive electrostatic discharges (ESD). These robust TVS diodes can safely absorb repetitive ESD strikes at $\pm 30\text{kV}$ (contact and air discharge, IEC 61000-4-2) without performance degradation. Additionally, SP1124T offers up to 20A 8/20 surge rating with low clamping voltages.

Features

- ESD, IEC 61000-4-2, $\pm 30\text{kV}$ contact, $\pm 30\text{kV}$ air
- EFT, IEC 61000-4-4, 40A (5/50ns)
- Lightning, IEC 61000-4-5 2nd edition, 20A ($t_p=8/20\mu\text{s}$)
- Low clamping voltage
- Low leakage current
- Moisture Sensitivity Level(MSL -1)
- Lead free and RoHS compliant
- AEC-Q101 qualified

Applications

- Switches / Buttons
- Test Equipment / Instrumentation
- Point-of-Sale Terminals
- Medical Equipment
- Notebooks / Desktops / Servers
- Computer Peripherals
- Automotive Electronics

Life Support Note:

Not Intended for Use in Life Support or Life Saving Applications

The products shown herein are not designed for use in life sustaining or life saving applications unless otherwise expressly indicated.

Absolute Maximum Ratings

Symbol	Parameter	Value	Units
Ppk	Peak Pulse Power (tp=8/20μs)	858	W
T _{OP}	Operating Temperature	-40 to 125	°C
T _{STOR}	Storage Temperature	-55 to 150	°C

CAUTION: Stresses above those listed in "Absolute Maximum Ratings" may cause permanent damage to the component. This is a stress only rating and operation of the component at these or any other conditions above those indicated in the operational sections of this specification is not implied.

Electrical Characteristics (T_{OP}=25°C)

Parameter	Symbol	Test Conditions	Min	Typ	Max	Units
Reverse Standoff Voltage	V _{RWM}	I _R ≤ 1μA			24.0	V
Reverse Voltage Drop	V _R	I _R = 1mA	26.7			V
Leakage Current	I _{LEAK}	V _R = 24V			1.0	μA
Clamp Voltage ¹	V _C	I _{PP} = 1A, t _p = 8/20μs, Fwd		29.0		V
		I _{PP} = 20A, t _p = 8/20μs, Fwd		42.9		V
Dynamic Resistance ²	R _{DYN}	TLP, t _p = 100ns, I/O to GND		0.1		Ω
Peak Pulse Current	I _{PP}	t _p = 8/20μs			20.0	A
ESD Withstand Voltage ¹	V _{ESD}	IEC 61000-4-2 (Contact Discharge)	±30			kV
		IEC 61000-4-2 (Air Discharge)	±30			kV
Diode Capacitance ¹	C _{I/O-GND}	Reverse Bias=0V, f=1MHz		130		pF

Note:

- Parameter is guaranteed by design and/or component characterization.
- Transmission Line Pulse (TLP) with 100ns width, 2ns rise time, and average window t1=70ns to t2= 90ns

8/20μs Pulse Waveform

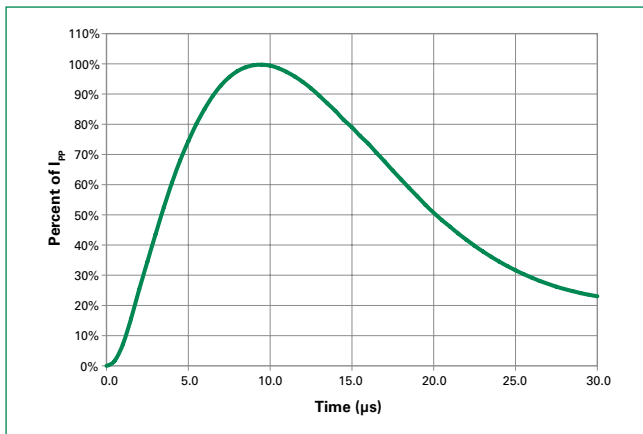

Transmission Line Pulsing (TLP) Plot

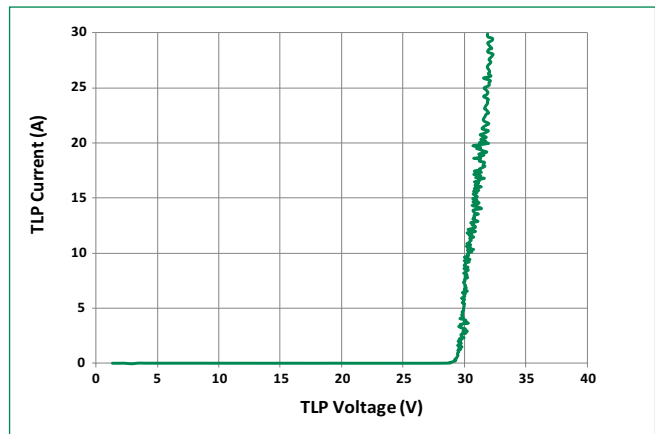

Capacitance vs. Bias

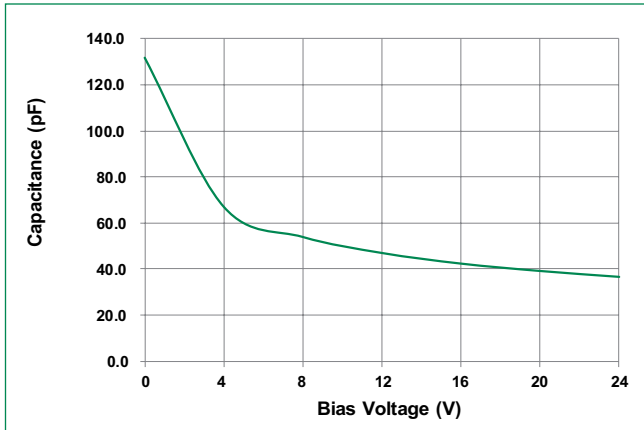

Clamping voltage vs. I_{pp} for 8/20 μ s waveshape

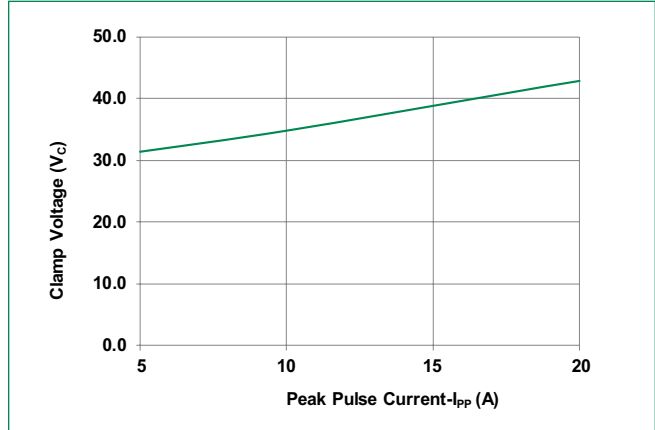

IEC 61000 -4-2 +8 kV Contact ESD Clamping Voltage

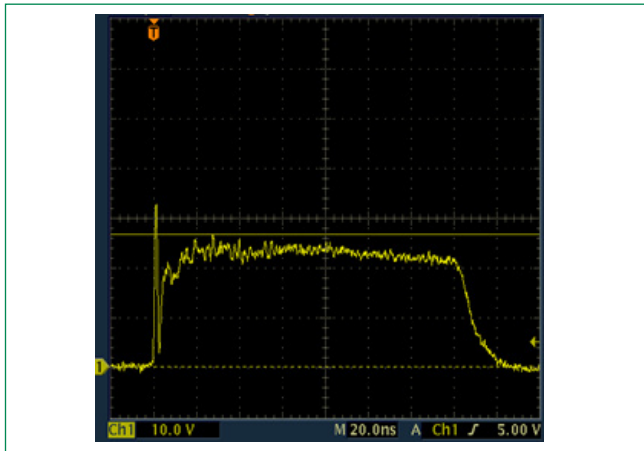

IEC 61000 -4-2 -8 kV Contact ESD Clamping Voltage

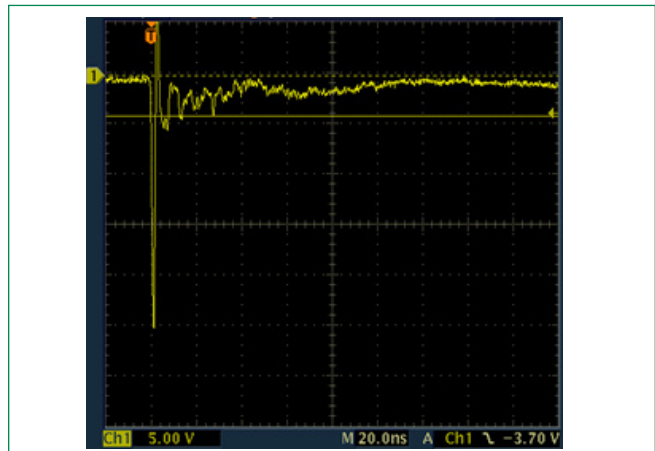

Soldering Parameters

Reflow Condition		Pb – Free assembly
Pre Heat	- Temperature Min ($T_{s(min)}$)	150°C
	- Temperature Max ($T_{s(max)}$)	200°C
	- Time (min to max) (t_s)	60 – 180 secs
Average ramp up rate (Liquidus) Temp (T_L) to peak		3°C/second max
$T_{s(max)}$ to T_L - Ramp-up Rate		3°C/second max
Reflow	- Temperature (T_L) (Liquidus)	217°C
	- Temperature (t_L)	60 – 150 seconds
Peak Temperature (T_p)		260 $^{+0/-5}$ °C
Time within 5°C of actual peak Temperature (t_p)		20 – 40 seconds
Ramp-down Rate		6°C/second max
Time 25°C to peak Temperature (T_p)		8 minutes Max.
Do not exceed		260°C

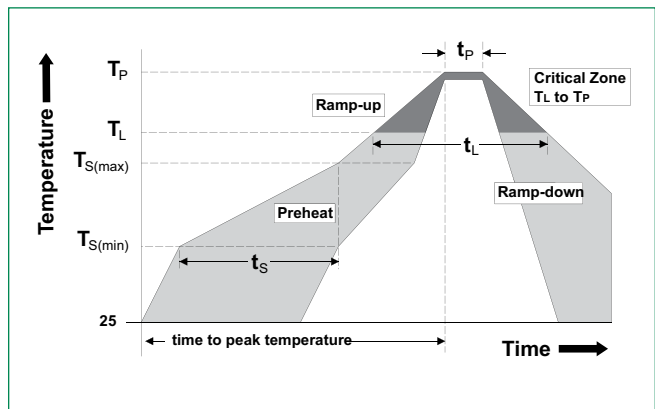

Part Marking System

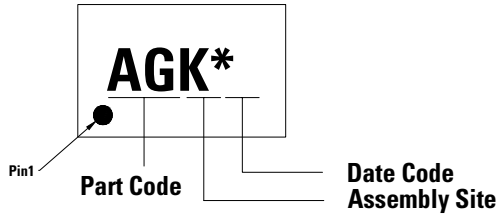

Part Code :
AG = SP1124T-01UTG

Part Numbering System

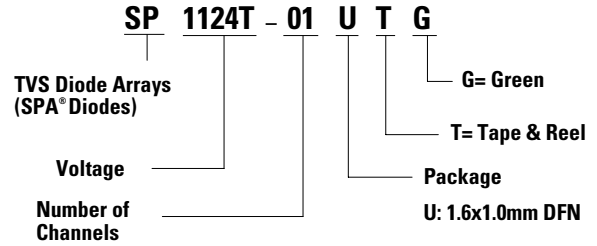

Ordering Information

Part Number	Package	Marking	Min. Order Qty.
SP1124T-01UTG	1.6x1.0mm DFN	AGKx	3000

Package Dimensions

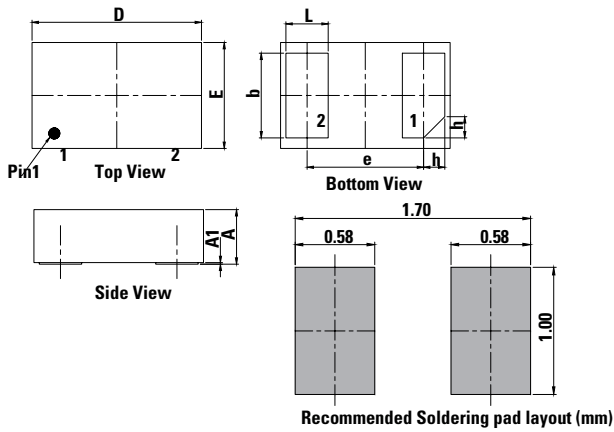

Symbol	1.6x1.0mm DFN		
	Millimeters		
	Min	Nor	Max
A	0.40	0.45	0.50
A1	-	0.02	0.05
D	1.55	1.60	1.65
E	0.95	1.00	1.05
b	0.75	0.80	0.85
L	0.35	0.40	0.45
e	1.10 BSC		
h	0.15	0.20	0.25

Embossed Carrier Tape & Reel Specification

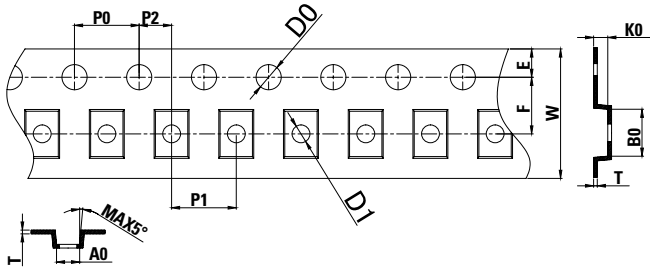

User Feeding Direction →

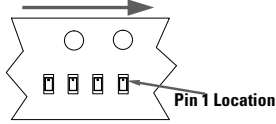

Symbol	Millimeters
A0	1.15 +/- 0.05
B0	1.75 +/- 0.05
K0	0.63 +/- 0.05
P0	4.00 +/- 0.10
P1	4.00 +/- 0.10
P2	2.00 +/- 0.05
T	0.20 +/- 0.05
E	1.75 +/- 0.10
F	3.50 +/- 0.05
D0	1.55 +/- 0.10
D1	0.05 +0.10
W	8.00 +0.20/- 0.10

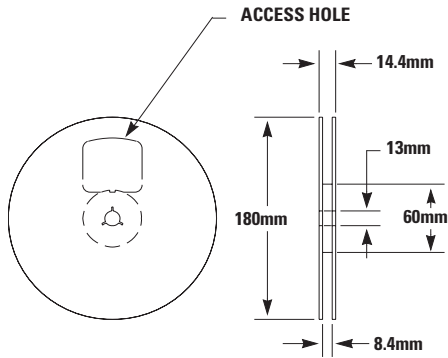

Disclaimer Notice - Information furnished is believed to be accurate and reliable. However, users should independently evaluate the suitability of and test each product selected for their own applications. Littelfuse products are not designed for, and may not be used in, all applications. Read complete Disclaimer Notice at www.littelfuse.com/disclaimer-electronics.