

# SP1326 15pF 30kV Bidirectional Discrete TVS

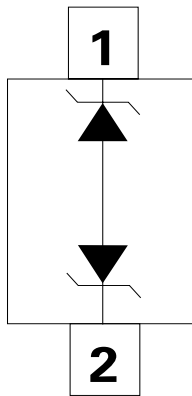

## Pinout and Functional Block Diagram



## Description

The SP1326 back-to-back diodes are fabricated in a proprietary silicon avalanche technology. These diodes provide a high ESD (electrostatic discharge) protection level for electronic equipment. The SP1326 TVS can safely absorb repetitive ESD strikes at  $\pm 30\text{kV}$  (contact and air discharge, IEC 61000-4-2) without performance degradation. Additionally, each diode can safely dissipate 4A of 8/20 $\mu\text{s}$  surge current (IEC 61000-4-5 2<sup>nd</sup> edition) with very low clamping voltages.

## Features

- ESD, IEC 61000-4-2,  $\pm 30\text{kV}$  contact,  $\pm 30\text{kV}$  air
- EFT, IEC 61000-4-4, 40A (5/50ns)
- Lightning, 4A (8/20 $\mu\text{s}$  as defined in IEC 61000-4-5 2<sup>nd</sup> edition)
- AEC-Q101 qualified and PPAP capable
- Low leakage current of 0.02 $\mu\text{A}$  (TYP) at 5V
- Space efficient
- Halogen free, Lead free and RoHS compliant
- Moisture Sensitivity Level (MSL -1)

## Applications

- Mobile phones
- Smart phones
- Smart watches
- Tablets
- Portable navigation components
- Portable medical components

## Application Example

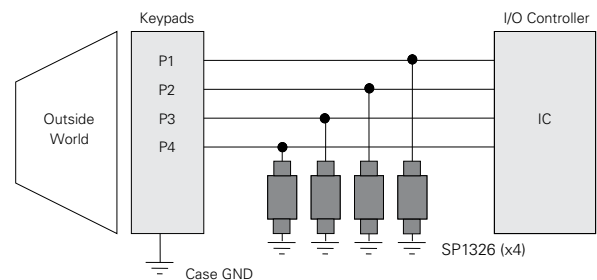

Life Support Note:

**Not Intended for Use in Life Support or Life Saving Applications**

The products shown herein are not designed for use in life sustaining or life saving applications unless otherwise expressly indicated.

### Absolute Maximum Ratings

Symbol	Parameter	Value	Units
$I_{PP}$	Peak Pulse Current ( $t_p=8/20\mu s$ )	4	A
$T_{OP}$	Operating Temperature	-40 to 125	°C
$T_{STOR}$	Storage Temperature	-55 to 150	°C

**CAUTION:** Stresses above those listed in "Absolute Maximum Ratings" may cause permanent damage to the component. This is a stress only rating and operation of the component at these or any other conditions above those indicated in the operational sections of this specification is not implied.

### Electrical Characteristics ( $T_{OP}=25^\circ C$ )

Parameter	Symbol	Test Conditions	Min	Typ	Max	Units
Reverse Standoff Voltage	$V_{RWM}$	$I_R=1\mu A$			6.0	V
Breakdown Voltage	$V_{BR}$	$I_R=1mA$		7.8		V
Reverse Leakage Current	$I_{LEAK}$	$V_R=5V$		0.02	0.5	$\mu A$
Clamp Voltage <sup>1</sup>	$V_C$	$I_{PP}=1A, t_p=8/20\mu s, I/O$ to I/O		12.0		V
		$I_{PP}=4A, t_p=8/20\mu s, I/O$ to I/O		15.5		V
Dynamic Resistance <sup>2</sup>	$R_{DYN}$	TLP, $t_p=100ns, I/O$ to I/O		0.35		$\Omega$
ESD Withstand Voltage <sup>1</sup>	$V_{ESD}$	IEC 61000-4-2 (Contact Discharge)	$\pm 30$			kV
		IEC 61000-4-2 (Air Discharge)	$\pm 30$			kV
Diode Capacitance <sup>1</sup>	$C_{I/O-I/O}$	Reverse Bias=0V, f=1MHz		15		pF
		Reverse Bias=2.5V, f=1MHz		12		pF

**Note:**

<sup>1</sup> Parameter is guaranteed by design and/or component characterization.

<sup>2</sup> Transmission Line Pulse (TLP) with 100ns width, 2ns rise time, and average window  $t1=70ns$  to  $t2=90ns$

### Capacitance vs. Reverse Bias

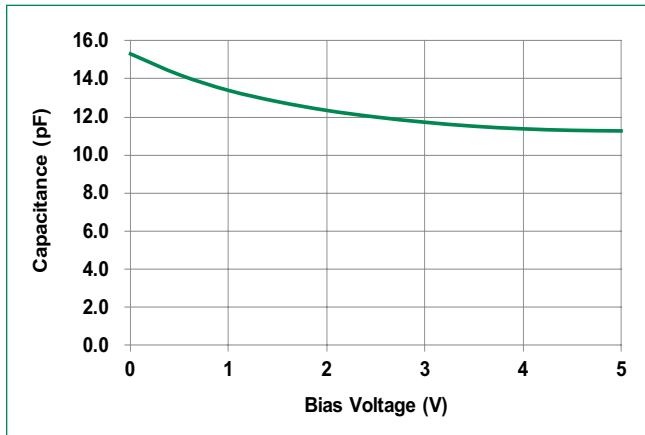

### 8/20 $\mu s$ Pulse Waveform

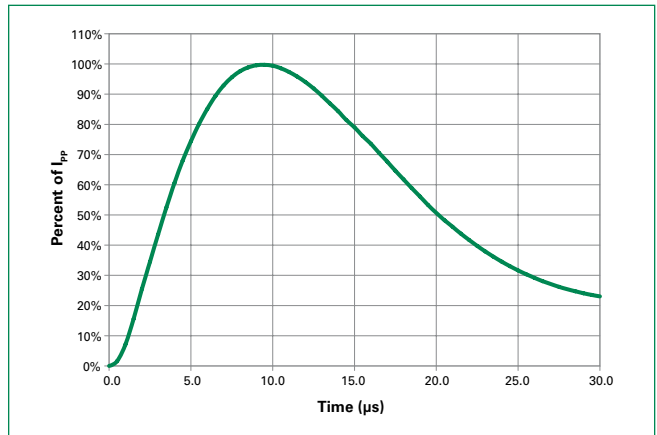

**Clamping voltage vs.  $I_{pp}$  for 8/20 $\mu$ S waveshape**

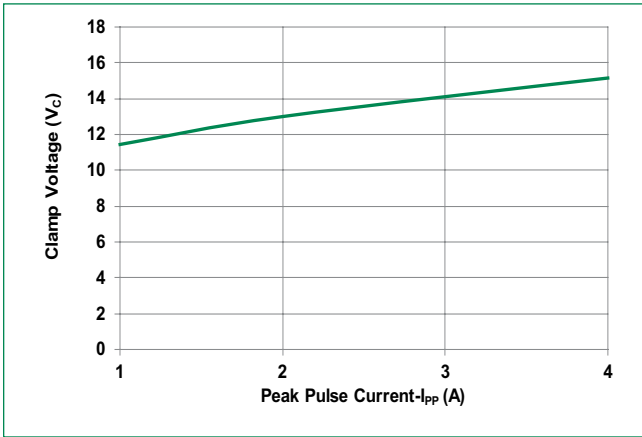

**Positive Transmission Line Pulsing (TLP) Plot**

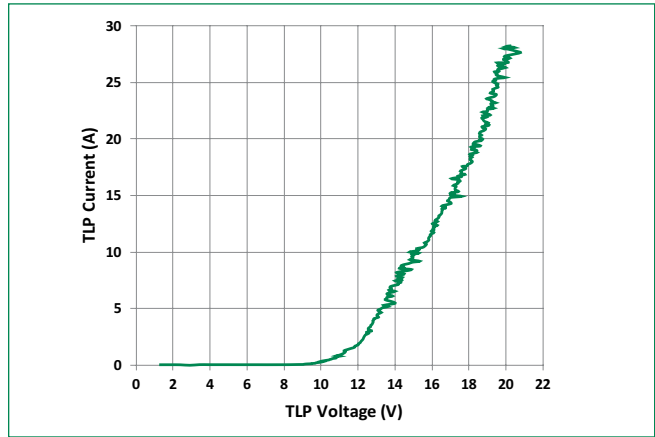

**IEC 61000-4-2 +8 kV Contact ESD Clamping Voltage**

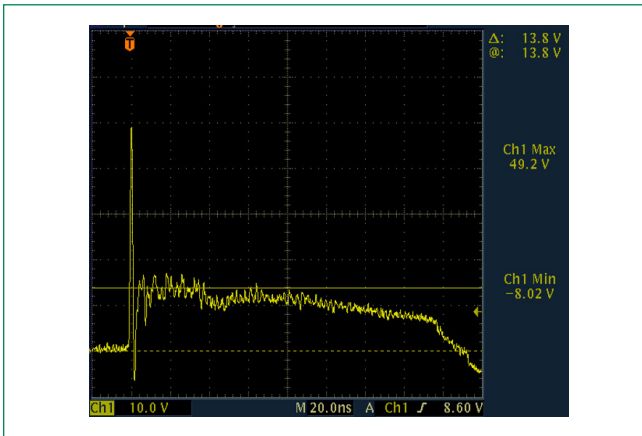

**Soldering Parameters**

<b>Reflow Condition</b>		Pb – Free assembly
<b>Pre Heat</b>	- Temperature Min ( $T_{s(min)}$ )	150°C
	- Temperature Max ( $T_{s(max)}$ )	200°C
	- Time (min to max) ( $t_s$ )	60 – 180 secs
<b>Average ramp up rate (Liquidus) Temp (<math>T_L</math>) to peak</b>		3°C/second max
<b><math>T_{s(max)}</math> to <math>T_L</math> - Ramp-up Rate</b>		3°C/second max
<b>Reflow</b>	- Temperature ( $T_L$ ) (Liquidus)	217°C
	- Temperature ( $t_L$ )	60 – 150 seconds
<b>Peak Temperature (<math>T_p</math>)</b>		260 $^{+0.5}$ °C
<b>Time within 5°C of actual peak Temperature (<math>t_p</math>)</b>		20 – 40 seconds
<b>Ramp-down Rate</b>		6°C/second max
<b>Time 25°C to peak Temperature (<math>T_p</math>)</b>		8 minutes Max.

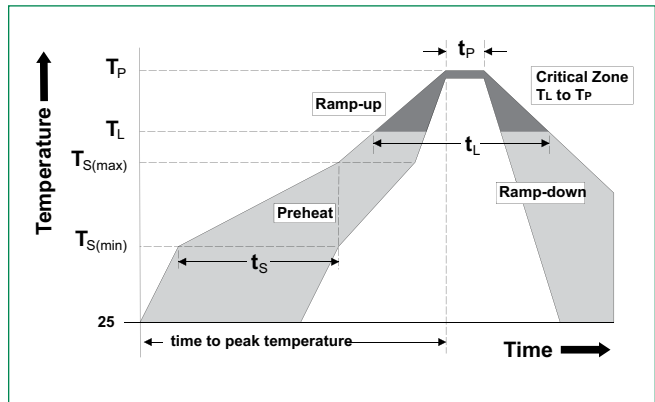

**Part Numbering System**

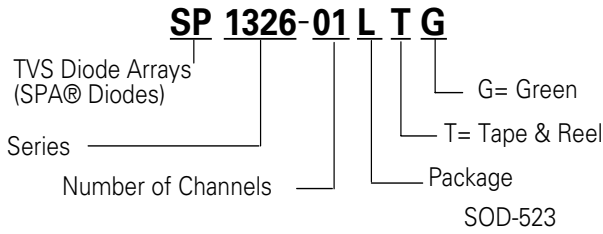

**Product Characteristics**

<b>Lead Plating</b>	Matte Tin
<b>Lead Material</b>	Copper Alloy
<b>Substrate material</b>	Silicon
<b>Body Material</b>	Molded Compound
<b>Flammability</b>	UL Recognized compound meeting flammability rating V-0.

**Ordering Information**

Part Number	Package	Min. Order Qty.
SP1326-01LTG	SOD-523	5000

**Part Marking System**



**Package Dimensions – SOD-523**

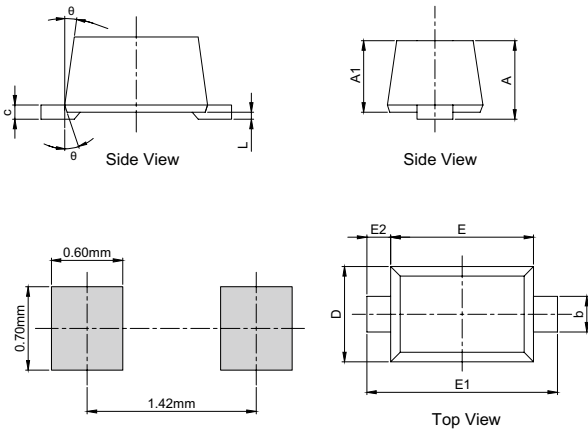

Symbol	Millimeters		Inches	
	Min	Max	Min	Max
<b>A</b>	0.51	0.77	0.020	0.030
<b>A1</b>	0.50	0.70	0.020	0.028
<b>b</b>	0.25	0.35	0.010	0.014
<b>c</b>	0.08	0.15	0.003	0.006
<b>D</b>	0.75	0.85	0.030	0.033
<b>E</b>	1.10	1.30	0.043	0.051
<b>E1</b>	1.50	1.70	0.059	0.067
<b>E2</b>	0.20 REF		0.001 REF	
<b>L</b>	0.01	0.07	0.000	0.003
<b>Ø</b>	7° REF		7° REF	

**Embossed Carrier Tape & Reel Specification – SOD-523**

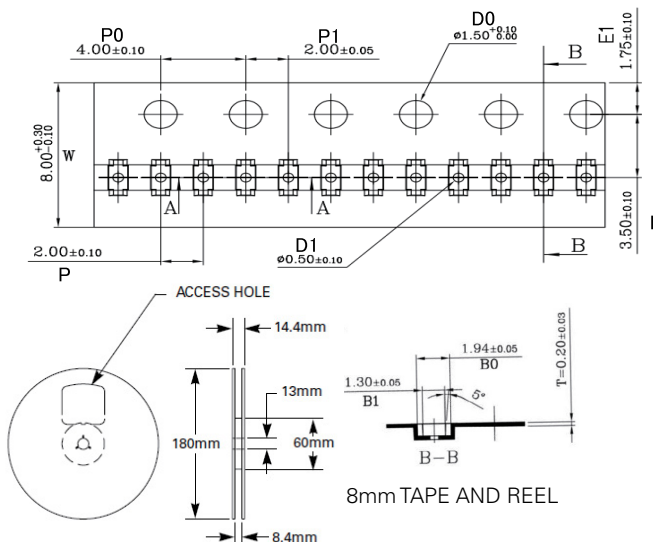

Symbol	Millimetres		Inches	
	Min	Max	Min	Max
<b>A0</b>	0.91	1.01	0.036	0.040
<b>B0</b>	1.89	1.99	0.074	0.078
<b>D0</b>	1.50	1.60	0.059	0.063
<b>D1</b>	0.40	0.60	0.016	0.024
<b>E1</b>	1.65	1.85	0.065	0.073
<b>F</b>	3.40	3.60	0.134	0.142
<b>P0</b>	3.90	4.10	0.154	0.161
<b>P</b>	1.90	2.10	0.075	0.083
<b>P1</b>	1.95	2.05	0.077	0.081
<b>K0</b>	0.68	0.78	0.027	0.031
<b>T</b>	0.17	0.23	0.007	0.009
<b>W</b>	7.90	8.30	0.311	0.327

**Disclaimer Notice** - Information furnished is believed to be accurate and reliable. However, users should independently evaluate the suitability of and test each product selected for their own applications. Littelfuse products are not designed for, and may not be used in, all applications. Read complete Disclaimer Notice at <http://www.littelfuse.com/disclaimer-electronics>.