

SP5001 Series 4 Channel TVS Common Mode Filter

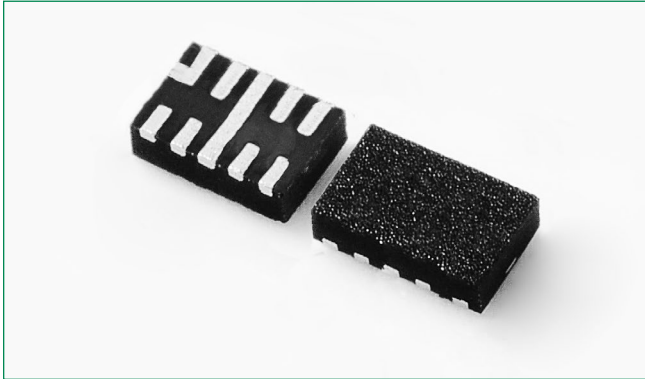

OBSOLETE DATE: 12/31/2022 PCN/ECN# ESU270-77
REPLACED BY: NA



Description

The SP5001 Series is a highly integrated Common Mode Filter (CMF) providing both ESD protection and EMI common mode noise filtering for systems using high speed differential serial interfaces, such as MIPI D-PHY or HDMI.

The SP5001 Series can protect and filter two differential line pairs in a small RoHS-compliant TDFN-10 package, with cost and space savings over discrete solutions.

Pinout

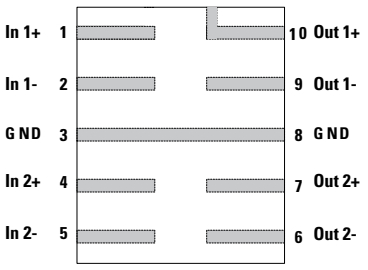

Note :This drawing is not to scale.

Features

- Large differential bandwidth > 2.5 GHz
- High Common Mode Stop Band Attenuation:
 - > 25 dB at 700 MHz
 - > 30 dB at 800 MHz
- ±15kV ESD protection per channel (IEC 61000-4-2 Level 4, contact discharge and ±30kV air discharge)
- TDFN-10 2.50mm × 2.00mm × 0.75mm package with 0.50mm lead pitch
- RoHS-compliant, Lead-free packaging
- Moisture Sensitivity Level (MSL-1)

Functional Block Diagram

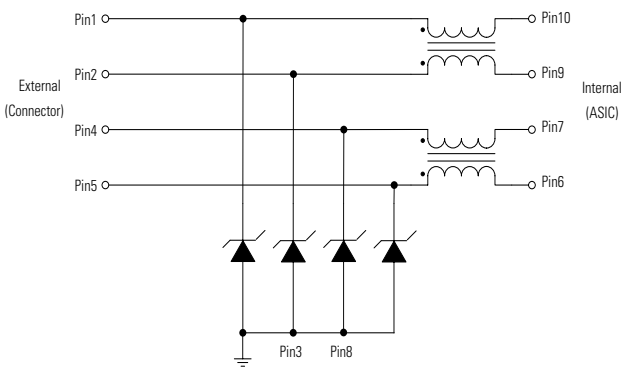

Applications

- HDMI/DVI Display in Mobile Phones
- MIPI D-PHY (CSI-2, DSI, etc) in Mobile Phones and Digital Still Cameras

Absolute Maximum Ratings

Symbol	Parameter	Value	Units
I_{DC}	DC Current Per Line	100	mA
P_{DC}	DC Package Power Rating	0.5	W
T_{OP}	Operating Temperature	-40 to 125	°C
T_{STOR}	Storage Temperature	-55 to 150	°C

CAUTION: Stresses above those listed in "Absolute Maximum Ratings" may cause permanent damage to the component. This is a stress only rating and operation of the component at these or any other conditions above those indicated in the operational sections of this specification is not implied.

Electrical Characteristics ($T_{OP}=25^{\circ}C$)

Parameter	Symbol	Test Conditions	Min	Typ	Max	Units
Channel Resistance	R_{CH}	Pins 1-10, 2-9, 4-7 and 5-6		8.0		Ω
Total Channel Capacitance	C_{TOTAL}	$V_{I/O} = 1.65V_{DC}$ Reverse Bias; $f=1MHz, 30mV_{AC}$		0.8	1.3	pF
Reverse Standoff Voltage	V_{RWM}				5.0	V
Breakdown Voltage	V_{BR}	$I_T=1mA$	6.0	8.0	10.0	V
Forward Voltage at I_F	V_F	$I_F=1mA$	0.4	0.7	1.5	V
Reverse Leakage Current	I_{LEAK}	$V_{I/O} = 3.3V$		0.01	0.10	μA
Dynamic Resistance ^{2 3}	R_{DYN}	Positive ($tp=8/20\mu s$)		1.3		Ω
		Negative ($tp=8/20\mu s$)		0.7		
		TLP, $tp=100ns, I/O$ to GND		0.36		
ESD Withstand Voltage ^{1 2}	V_{ESD}	IEC 61000-4-2 (Contact Discharge)	± 15			kV
		IEC 61000-4-2 (Air Discharge)	± 30			kV
Differential Mode Cutoff Frequency ²	F_{3dB}	$Z_{SOURCE}=50 \Omega, Z_{LOAD} 50 \Omega$		2.5		GHz
Common Mode Stop Band Attenuation ²	F_{α}	$f=800MHz$		30		dB

Notes:

- ESD zapping at I/O pins (1,2,4,5) with respect to GND.
- Guaranteed by design.
- Transmission Line Pulse (TLP) with 100ns width and 200ps rise time.

Differential Mode Attenuation SDD21 vs. Frequency ($Z_{diff} = 100\Omega$)

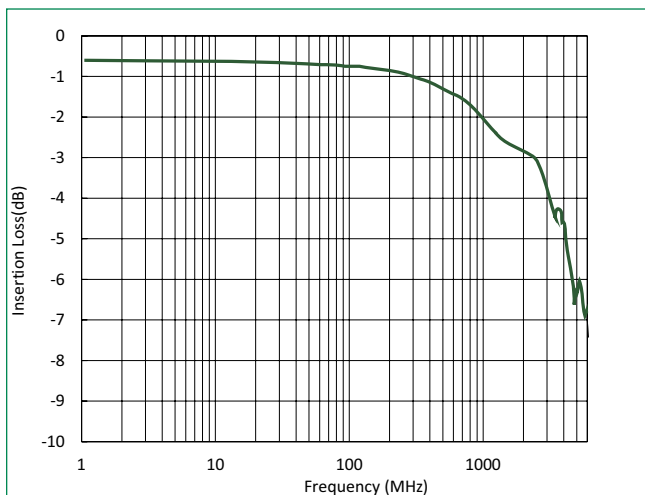

Common Mode Attenuation SCC21 vs. Frequency ($Z_{comm} = 50\Omega$)

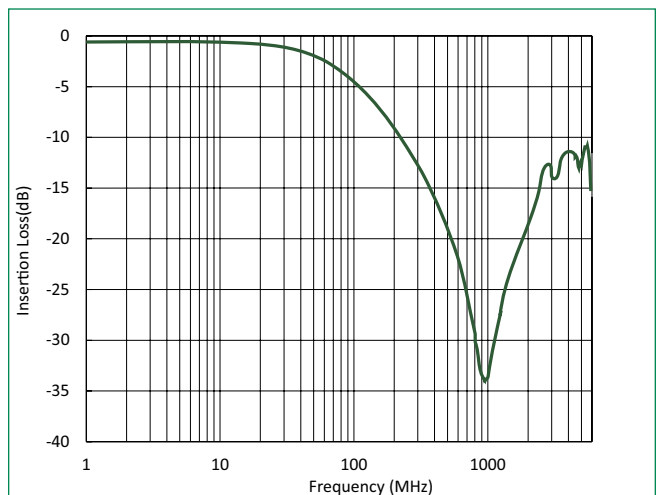

Differential Return Loss SDD11 vs. Frequency (Zdiff = 100Ω)

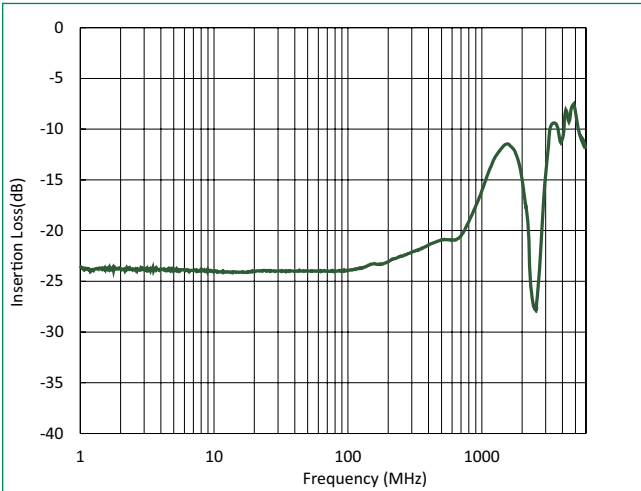

Differential Return Loss SDD22 vs. Frequency (Zdiff = 100Ω)

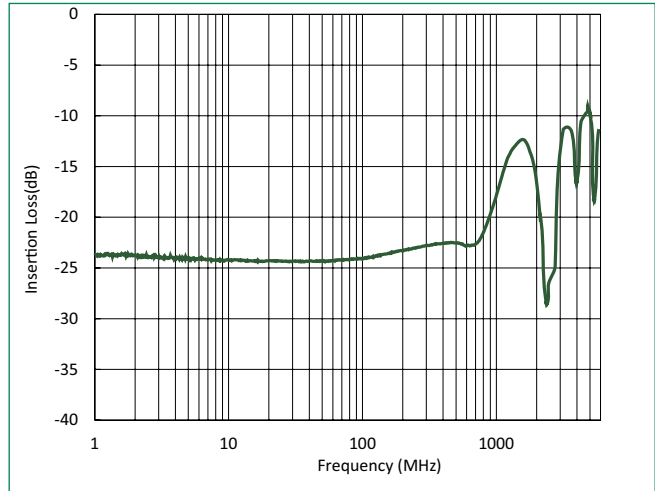

Transmission Line Pulsing (TLP) Plot

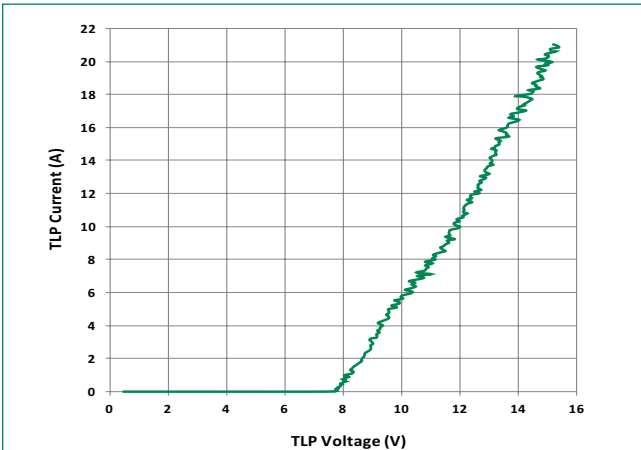

Part Numbering System

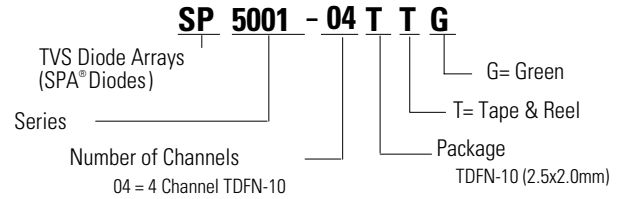

Part Marking System

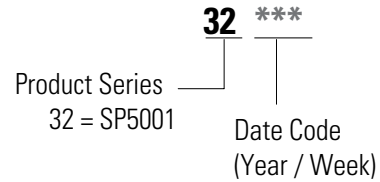

Soldering Parameters

Reflow Condition		Pb – Free assembly
Pre Heat	- Temperature Min ($T_{s(min)}$)	150°C
	- Temperature Max ($T_{s(max)}$)	200°C
	- Time (min to max) (t_s)	60 – 180 secs
Average ramp up rate (Liquidus) Temp (T_L) to peak		3°C/second max
$T_{S(max)}$ to T_L - Ramp-up Rate		3°C/second max
Reflow	- Temperature (T_L) (Liquidus)	217°C
	- Temperature (t_L)	60 – 150 seconds
Peak Temperature (T_p)		260 ^{+0/-5} °C
Time within 5°C of actual peak Temperature (t_p)		20 – 40 seconds
Ramp-down Rate		6°C/second max
Time 25°C to peak Temperature (T_p)		8 minutes Max.
Do not exceed		260°C

Ordering Information

Part Number	Package	Size	Min. Order Qty.
SP5001-04TTG	TDFN-10	2.5x2.0mm	3000

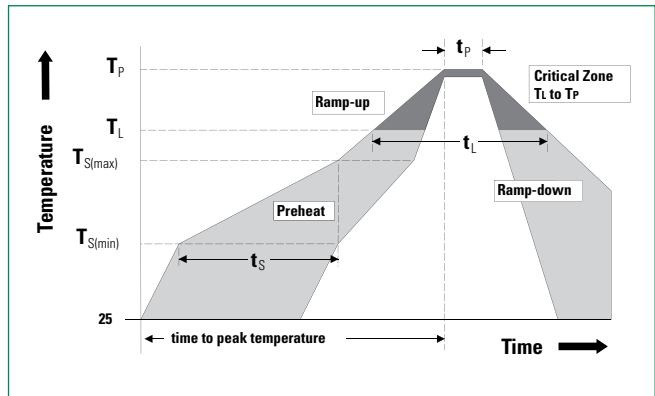

Package Dimensions –TDFN-10

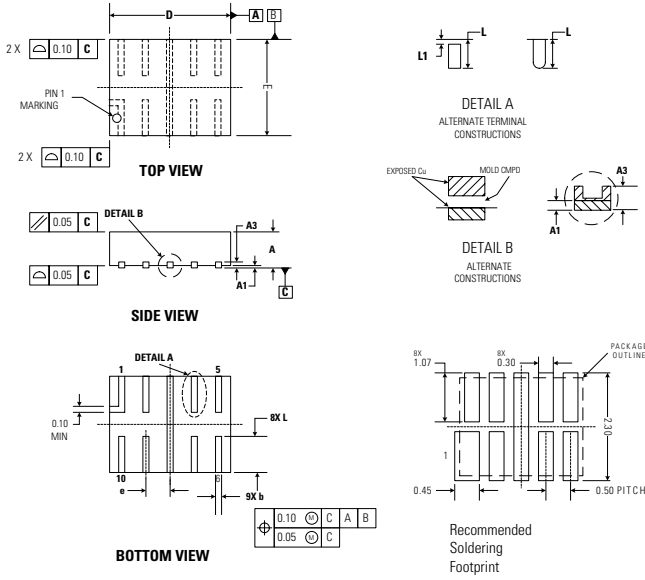

Symbol	TDFN-10			
	JEDEC MO-229			
	Millimeters		Inches	
	Min	Max	Min	Max
A	0.70	0.80	0.028	0.031
A1	0.00	0.05	0.000	0.002
A3	0.2 REF		0.008 REF	
b	0.15	0.25	0.006	0.010
D	2.50 BSC		0.098 BSC	
E	2.00 BSC		0.079 BSC	
e	0.50 BSC		0.020 BSC	
L	0.70	0.90	0.028	0.035
L1	0.05	0.15	0.002	0.006

Tape & Reel Specification –TDFN-10

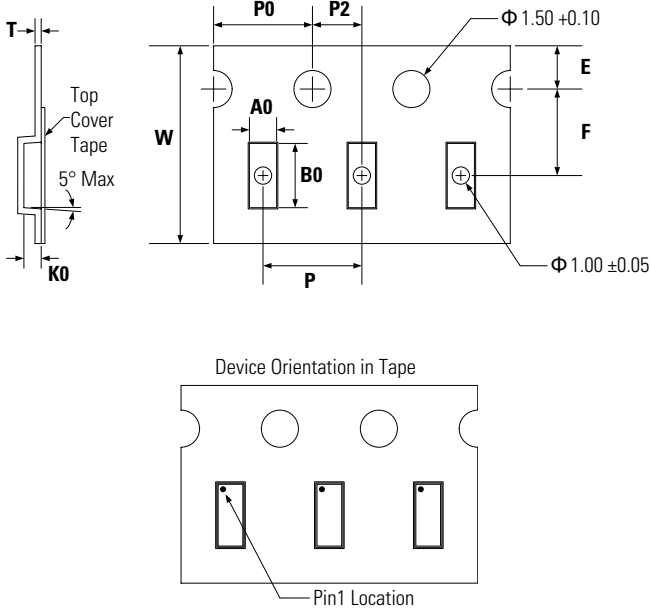

Symbol	Dimensions
	Millimetres
E	1.75 +/- 0.10
F	3.5 +/- 0.05
P	4.0 +/- 0.10
P0	4.0 +/- 0.10
P2	2.0 +/- 0.05
W	8.00 +0.30/- 0.10
A0	2.19 +/- 0.05
B0	2.77 +/- 0.05
K0	1.05 +/- 0.05
T	0.25 +/- 0.02