

SP5003 Series 4 Channel Common Mode Filter

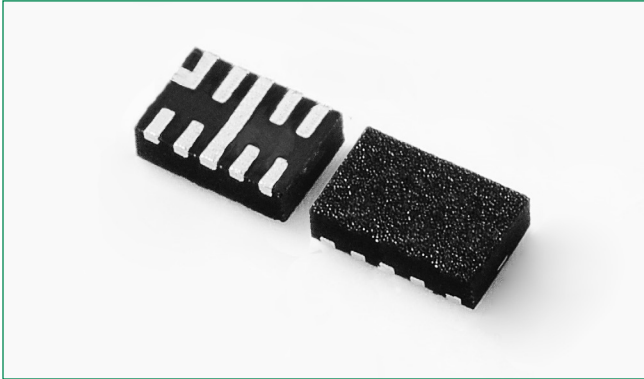

OBSOLETE DATE: 12/31/2020 PCN/ECN# ESU270-49
REPLACED BY: N/A



Description

The SP5003 Series is a highly integrated Common Mode Filter (CMF) providing both ESD protection and EMI common mode noise filtering for systems using high speed differential serial interfaces, such as MIPI D-PHY or HDMI.

The SP5003 Series can protect and filter two differential line pairs in a small RoHS-compliant TDFN-10 package, with cost and space savings over discrete solutions.

Pinout

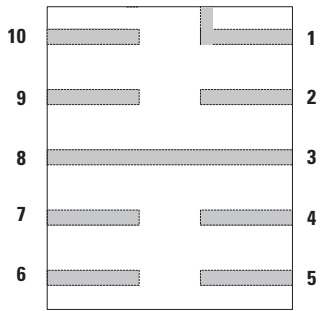

Note: Bottom-view

Features

- Large differential bandwidth > 4.0 GHz
- High Common Mode Stop Band Attenuation: > 16 dB at 900 MHz
- Common Mode Impedance: $Z_c: 32\Omega$ at 100 MHz
- TDFN-10 2.50mm × 2.00mm × 0.75mm package with 0.50mm lead pitch
- ±15kV ESD protection per channel (IEC 61000-4-2 Level 4, contact discharge)
- RoHS-compliant, Lead-free packaging
- Moisture Sensitivity Level (MSL-1)

Functional Block Diagram

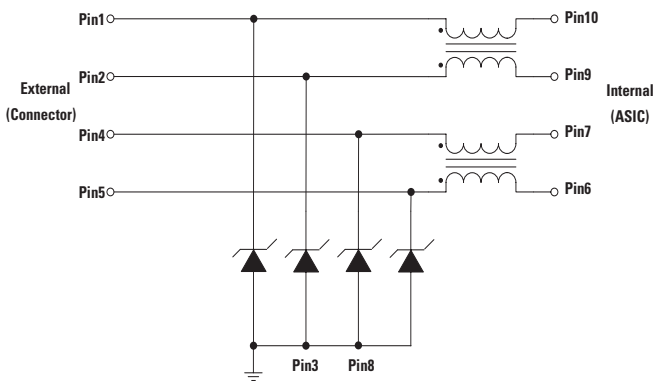

Applications

- HDMI/DVI Display in Mobile Phones
- MIPI D-PHY (CSI-2, DSI, etc) in Mobile Phones and Digital Still Cameras

Absolute Maximum Ratings

Symbol	Parameter	Value	Units
I_{DC}	DC Current Per Line	100	mA
P_{DC}	DC Package Power Rating	0.5	Watts
T_{OP}	Operating Temperature	-40 to 125	°C
T_{STOR}	Storage Temperature	-55 to 150	°C

CAUTION: Stresses above those listed in "Absolute Maximum Ratings" may cause permanent damage to the component. This is a stress only rating and operation of the component at these or any other conditions above those indicated in the operational sections of this specification is not implied.

Electrical Characteristics ($T_{OP}=25^{\circ}C$)

Parameter	Symbol	Test Conditions	Min	Typ	Max	Units
Channel Resistance	R_{CH}	Pins 1-10, 2-9, 4-7 and 5-6		3.5	5.0	Ω
Total Channel Capacitance	C_{TOTAL}	$V_{I/O} = 1.65VDC$ Reverse Bias; $f=1MHz, 30mV_{AC}$		0.8	1.3	pF
Reverse Standoff Voltage	V_{RWM}				5.0	V
Breakdown Voltage	V_{BR}	$I_T=1mA$	6.0	8.0	10.0	V
Forward Voltage at I_F	V_F	$I_F=1mA$	0.4	0.7	1.5	V
Reverse Leakage Current	I_{LEAK}	$V_{Leak} = +3.3V$		0.01	0.10	μA
Dynamic Resistance ^{2,3}	R_{DYN}	Positive (tp=8/20 μs)		1.36		Ω
		Negative (tp=8/20 μs)		0.6		
		TLP, tp=100ns, I/O to GND		0.42		
ESD Withstand Voltage ^{1,2}	V_{ESD}	IEC 61000-4-2 (Contact Discharge)	± 15			kV
		IEC 61000-4-2 (Air Discharge)	± 30			kV
Differential Mode Cutoff Frequency ²	F_{3dB}	$Z_{SOURCE} = 50 \Omega, Z_{LOAD} = 50 \Omega$		4.0		GHz
Common Mode Impedance	Z_C	@100MHz		32		Ω
Common Mode Stop Band Attenuation ²	F_{atten}	f=900MHz		16		dB

Notes:

- ESD zapping at I/O pins (1,2,4,5) with respect to GND.
- Guaranteed by design.
- Transmission Line Pulse (TLP) with 100ns width and 200ps rise time.

Differential Mode Attenuation vs. Frequency

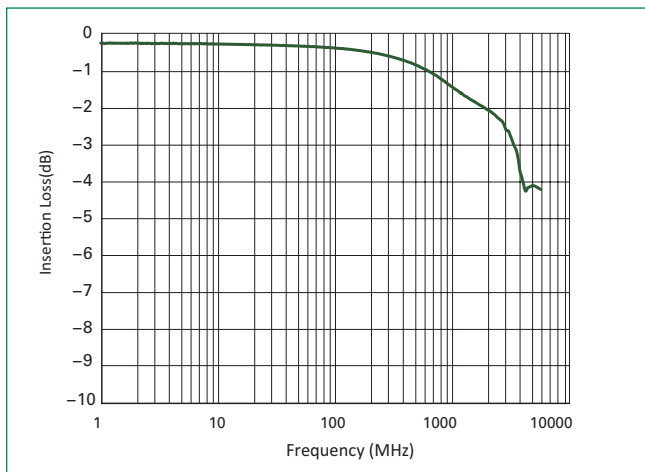

Common Mode Attenuation vs. Frequency

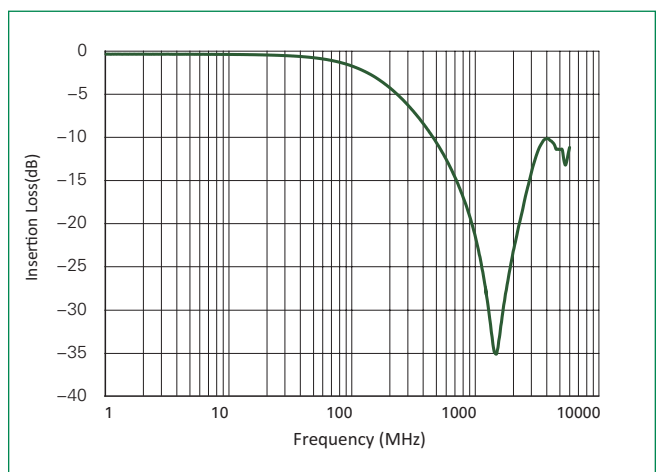

Transmission Line Pulsing (TLP) Plot

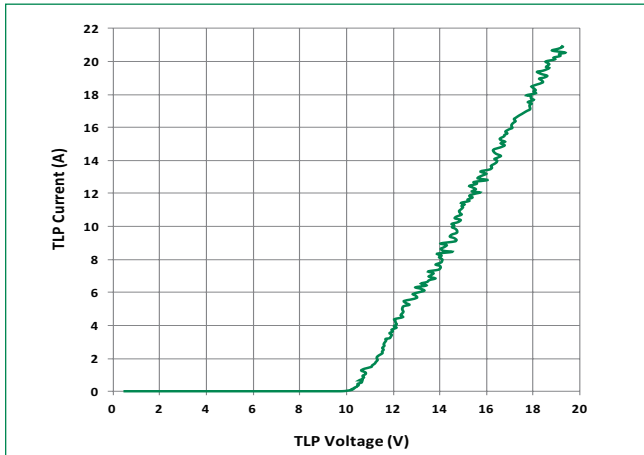

Soldering Parameters

Reflow Condition		Pb – Free assembly
Pre Heat	- Temperature Min ($T_{s(min)}$)	150°C
	- Temperature Max ($T_{s(max)}$)	200°C
	- Time (min to max) (t_s)	60 – 180 secs
Average ramp up rate (Liquidus) Temp (T_L) to peak		3°C/second max
$T_{s(max)}$ to T_L - Ramp-up Rate		3°C/second max
Reflow	- Temperature (T_L) (Liquidus)	217°C
	- Temperature (t_L)	60 – 150 seconds
Peak Temperature (T_p)		260 ^{+0/-5} °C
Time within 5°C of actual peak Temperature (t_p)		20 – 40 seconds
Ramp-down Rate		6°C/second max
Time 25°C to peak Temperature (T_p)		8 minutes Max.
Do not exceed		260°C

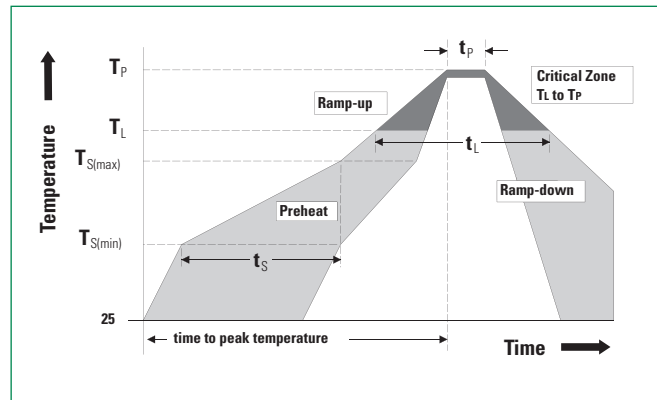

Ordering Information

Part Number	Package	Size	Marking	Min. Order Qty.
SP5003-04TTG	TDFN-10	2.5x2.0mm	42***	3000

Part Numbering System

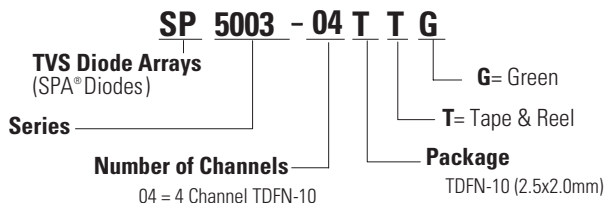

Part Marking System

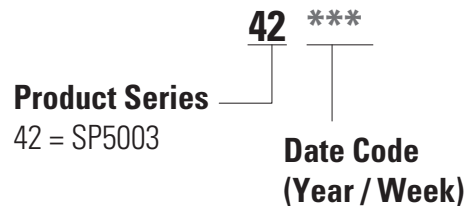

Package Dimensions –TDFN-10

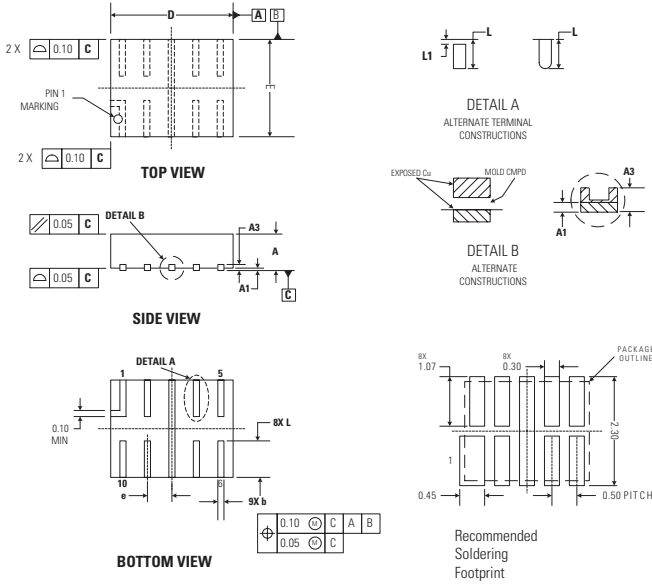

Symbol	TDFN-10			
	JEDEC MO-229			
	Millimeters		Inches	
	Min	Max	Min	Max
A	0.70	0.80	0.028	0.031
A1	0.00	0.05	0.000	0.002
A3	0.2 REF		0.008 REF	
b	0.15	0.25	0.006	0.010
D	2.50 BSC		0.098 BSC	
E	2.00 BSC		0.079 BSC	
e	0.50 BSC		0.020 BSC	
L	0.70	0.90	0.028	0.035
L1	0.05	0.15	0.002	0.006

Tape & Reel Specification –TDFN-10

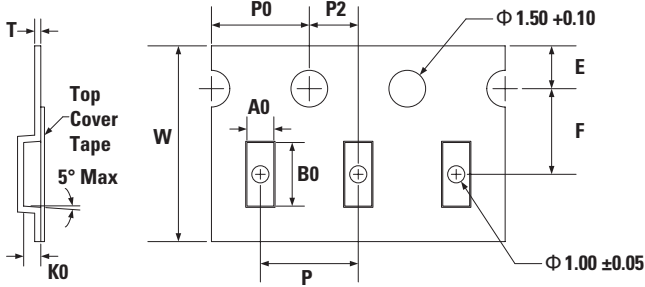

Symbol	Dimensions
	Millimetres
E	1.75 +/- 0.10
F	3.5 +/- 0.05
P	4.0 +/- 0.10
P0	4.0 +/- 0.10
P2	2.0 +/- 0.05
W	8.00 +0.30/- 0.10
A0	2.19 +/- 0.05
B0	2.77 +/- 0.05
K0	1.05 +/- 0.05
T	0.25 +/- 0.02

Device Orientation in Tape

